

SHS800X

SHS1000X

Handheld Digital Oscilloscope

User Manual

EN01B
May, 2022



Copyright and Declaration

Copyright

SIGLENT TECHNOLOGIES CO., LTD. All Rights Reserved.

Trademark Information

SIGLENT is the registered trademark of **SIGLENT TECHNOLOGIES CO., LTD.**

Declaration

SIGLENT products are protected by patent law in and outside of P.R.C.

SIGLENT reserves the right to modify or change parts of or all the specifications or pricing policies at company's sole decision.

Information in this publication replaces all previously corresponding material.

Any way of copying, extracting or translating the contents of this manual is not allowed without the permission of **SIGLENT**.

Product Certification

SIGLENT guarantees this product conforms to the national and industrial stands in China and other international stands conformance certification is in progress.

Contact Us

If you have any problem or requirement when using our products, please contact **SIGLENT TECHNOLOGIES CO., LTD**

Add: Blog No.4 & No.5, Antongda Industrial Zone, 3rd Liuxian Road, Bao'an District, Shenzhen, 518101, China

Tel: 400-878-0807

E-mail: sales@siglent.com

<http://www.siglent.com>

Introduction

This user manual includes important safety and installation information related to the SHS800X and SHS1000X handheld digital oscilloscopes, and includes simple tutorials for basic operation of the oscilloscope.

The series includes the following models:

Model	Analog Bandwidth
SHS820X	200 MHz bandwidth, 2-channel, 1 GSa/s Sample rate
SHS810X	100 MHz bandwidth, 2-channel, 1 GSa/s Sample rate
SHS1202X	200 MHz bandwidth, 2-channel, 1 GSa/s Sample rate
SHS1102X	100 MHz bandwidth, 2-channel, 1 GSa/s Sample rate

General Safety Summary

Carefully read the following safety precautions to avoid any personal injury or damage the instrument and avoid any products connected to it. To avoid potential hazards, please use the instrument as specified.

Protection is impaired if used in a manner not specified by the manufacturer.

Precautions for Operation

Before operating this product, special training is required to ensure that the user is physically, mentally and emotionally healthy and able to use the oscilloscope, otherwise it may cause personal injury or material damage. Employers、 operators are responsible for selecting suitable personnel to operate this product.

Before moving or transporting this product. Please read and observe the "Safety Transportation Matters" chapter.







As with all industrial products, the use of substances that cause allergic reactions such as nickel cannot generally be ruled out. If you experience an allergic reaction while using this product, please consult a doctor in time to determine the cause.



Before you perform mechanical or heat treatment or disassemble the oscilloscope, please be sure to read and pay special attention to the "Waste Disposal/Environmental Protection" chapter.

In the event of a fire, this product may release harmful substances (gas, liquids, etc.), causing health problems. Therefore, appropriate measures must be taken, for example, protective masks and protective clothing must be worn.

Safety Terms and Symbols

The meaning of symbols

symbol	meaning	symbol	meaning
	Warning		Power Switch
	Hazardous Voltage		Equipment meeting double insulation or reinforced insulation
	EarthGround		Indoor use only

	Lithium battery failure		EU label for separately recycled electrical and electronic equipment
---	-------------------------	---	--

Cue and its meaning

DANGER: Indicates direct injury or hazards that may happen.

WARNING: Indicates potential injury or hazards that may happen.

CAUTION: Indicates potential damage to the instrument or other property that may happen.

It must be consulted in all cases where  is marked, in order to find out the nature of the potential HAZARDS and any actions which have to be taken to avoid them.

Cue et sa signification

DANGER : Indique des blessures directes ou des dangers qui peuvent survenir.

WARNING : indique des blessures ou des dangers potentiels pouvant survenir.

CAUTION: indique des dommages potentiels à l'instrument ou à d'autres biens pouvant survenir.

Il doit être consulté dans tous les cas où  est marqué, afin de connaître la nature des DANGERS potentiels et les actions à entreprendre pour les éviter.

Safety Operation Matters

The product can only be operated under the safe conditions and positions specified by the manufacturer. Do not obstruct the ventilation of the oscilloscope during use. Failure to comply with the manufacturer's specifications may result in electric shock, fire, serious personal injury, or even death. Applicable local safety regulations and accident prevention rules must be observed in all applications.

When powered by a power adapter, it can only be used indoors.

Do not place the product on surface, vehicle, cabinet or tables that for reasons of weight or stability are unsuitable for this purpose. When installing the product and fastening it to the article or structures, always follow the manufacturer's installation instructions. If the

installation is not carried out in accordance with the requirements of the document, it may cause personal injury or even death.

Do not use this product in or near a heat source, and the ambient temperature cannot exceed the maximum temperature in the document or datasheet

Safety of Electricity

If you ignore the electrical safety methods, electric shock, fire and/or serious personal injury or death may occur.

Only use the power adapter and battery specified by the manufacturer to power the oscilloscope, and the power adapter can only work within its rated input voltage range.

Only the probe specified by the manufacturer can be used for testing. The use of non-manufacturer probes for testing may result in electric shock accidents.

The user is not allowed to damage the insulation protection layer of the oscilloscope and accessories. Doing so may cause electric shock. If an extension cord or terminal block is used for power supply, it must be checked regularly to ensure safe use.

Before use, please check whether the power cord and probe are damaged. If the power cord and probe are damaged, please do not continue to use the product.

Do not insert the AC plug of the power adapter into a dusty or dirty socket. Please make sure that the plug is firmly inserted into the socket, otherwise it may cause fire and/or injury due to sparks.

Do not overload any sockets, extension cords or connectors. Doing so may cause fire or electric shock.

When the measured voltage V_{rms} exceeds 30V, you should take appropriate measurement methods to avoid any danger.

Unless expressly permitted, do not remove the cover or any part of the shell while the product is in operation. Doing so will expose circuits and components, reduce the overvoltage level of the measurement, and may cause personal injury, fire, or damage to the oscilloscope.

Anything that is not designed to be placed on the external interface of this product should not be placed on the external interface, otherwise it will cause an internal short circuit and/or electric shock, fire or injury to the oscilloscope.

Do not place this product in an environment exceeding IP51, otherwise the oscilloscope will be damaged.

This product must be used in a dry environment, otherwise it may cause electric shock.

It is forbidden to use this product when condensation has formed or may form inside or on the surface of this product. For example, when the oscilloscope moves from a cold environment to a warm environment, the penetration of water increases the risk of electric shock.

Safety Transportation Matters

SIGLENT Technology provides handbags for the oscilloscope. For short-distance transportation under supervision, please make sure that the oscilloscope is turned off before putting it in the handbag. For long-distance transportation under unsupervised, please take out the battery and put it in your handbag.

In order to facilitate the user to hold, SIGLENT Technology has installed a fabric handle on the oscilloscope. This handle cannot be used as a focus point to be fixed on transportation equipment, such as cranes, forklifts, trucks, etc. It is the user's responsibility to fasten the product firmly to the transportation or lifting tool.

If you use this product in a vehicle, the driver is responsible for driving the vehicle safely and correctly. The manufacturer is not responsible for any accidents or collisions. Do not use this product in a moving vehicle to avoid distracting the driver. Use this product appropriately in the vehicle to prevent injury or other damage in the event of an accident.

Battery Usage

This product contains a rechargeable lithium battery pack. If misused, there is a risk of explosion, fire and / or serious personal injury, and even death in some cases.

The battery cannot be disassembled or crushed.

The battery or battery pack cannot be exposed to high temperature or fire, and it must be stored in direct sunlight. Keep the battery clean and dry. Use a dry, clean cloth to clean contaminated connectors.

The battery or battery pack cannot be short-circuited. Batteries or battery packs should not be stored in an environment that can easily cause a short circuit, such as boxes and drawers containing metal debris. The battery pack cannot be taken out of its original packaging before use.

Batteries and battery packs should not be exposed to any mechanical shock that exceeds the allowable level.

If the battery leaks, do not let the liquid contact the skin or eyes. If contact occurs, wash the contact area with plenty of water and seek medical assistance.

The power adapter specified by SIGLENT Technology must be used for charging, otherwise it may cause a fire or cause personal injury or death.

It must be charged in a well-ventilated room. During the charging process, the oscilloscope should not be covered by objects (such as blankets, towels, clothes), which will affect the heat dissipation effect and cause a serious fire.

Improper battery replacement may cause an explosion. For the reliability and safety of the oscilloscope, the battery model specified by SIGLENT Technology must be replaced.

Used batteries and battery packs must be recycled and separated from residual waste. Batteries contain hazardous waste, and local regulations on waste disposal and recycling must be followed.

Waste Disposal

The used batteries in the product must not be disposed of together with unsorted municipal waste, they must be collected separately and placed in designated recycling points.

If the product and its components are mechanically and/or thermally processed in a way beyond the intended use, hazardous substances may be released. Therefore, this product can only be disassembled by professional personnel. Improper disassembly may endanger your health. The local waste disposal regulations must be followed.

Safety Compliance

This section lists the safety standards with which the product complies.

U.S. nationally recognized testing laboratory listing

- UL 61010-1:2012/R:2018-11. Safety Requirements for Electrical Equipment for Measurement, Control, and Laboratory Use - Part 1: General Requirements.
- UL 61010-2-030:2018. Safety Requirements for Electrical Equipment for Measurement, Control, and Laboratory Use - Part 2-030: Particular requirements for testing and measuring circuits.
- UL 61010-2-033:2020. Safety Requirements for Electrical Equipment for Measurement, Control and Laboratory Use - Part 2-033: Particular Requirements for Hand-Held Multimeters for Domestic and Professional Use, Capable of Measuring Mains Voltage.

Canadian certification

- CAN/CSA-C22.2 No. 61010-1:2012/A1:2018-11. Safety Requirements for Electrical Equipment for Measurement, Control, and Laboratory Use - Part 1: General Requirements.
- CAN/CSA-C22.2 No. 61010-2-030:2018. Safety Requirements for Electrical Equipment for Measurement, Control, and Laboratory Use - Part 2-030: Particular requirements for testing and measuring circuits.
- CSA C22.2 No. 61010-2-033-2020. Safety Requirements For Electrical Equipment For Measurement, Control And Laboratory Use — Part 2-033: Particular Requirements For Hand-Held Multimeters For Domestic And Professional Use, Capable Of Measuring Mains Voltage

General Care and Cleaning

Care

Do not store or leave the instrument in direct sunshine for extended periods of time.

To avoid damages to the instrument or probes, please do not expose them to fog, liquid, or solvents.

Cleaning

Please perform the following steps to clean the instrument and probes regularly in accordance with its operating conditions.

Disconnect the instrument from all power sources and then clean with a soft wet cloth. Clean the loose dust on the outside of the instrument and probe with a soft cloth. When cleaning the LCD, take care to avoid scratching it.

To avoid damage to the surface of the instrument and probe, please do not use any corrosive liquid or chemical cleansers.

Make sure that the instrument is completely dry before restarting it to avoid potential short circuits or personal injury.

Measurement Category



WARNING

Make sure that no measurement overvoltage reach the product, or else the operator might expose to danger of electric shock.

Assurez-vous qu'aucune surtension de mesure n'atteigne le produit, sinon l'opérateur pourrait s'exposer à un risque de choc électrique.

IEC61010-2-030 defines the measurement category to rate the ability of measuring instruments to withstand short-term transient overvoltage outside of the working voltage. This product and its accessories can only be used in the environment of the nominal measurement category.

- 0- An instrument with no rated measurement category is used to measure circuits that are not directly connected to the mains, such as a circuit board powered by a battery or a secondary circuit with special protection. This measurement category is also called CAT I .
- CAT II:
For measurements installed in buildings, such as junction boxes, circuit breakers,

distribution boards and equipment permanently connected to fixed installations.

- CAT III:
Used for measurements installed in buildings, such as junction boxes, circuit breakers, distribution boards and equipment that are permanently connected to fixed installations.
- CAT IV:
It is used for measuring at the source of low-voltage devices, such as electricity meters and primary overcurrent protection devices.

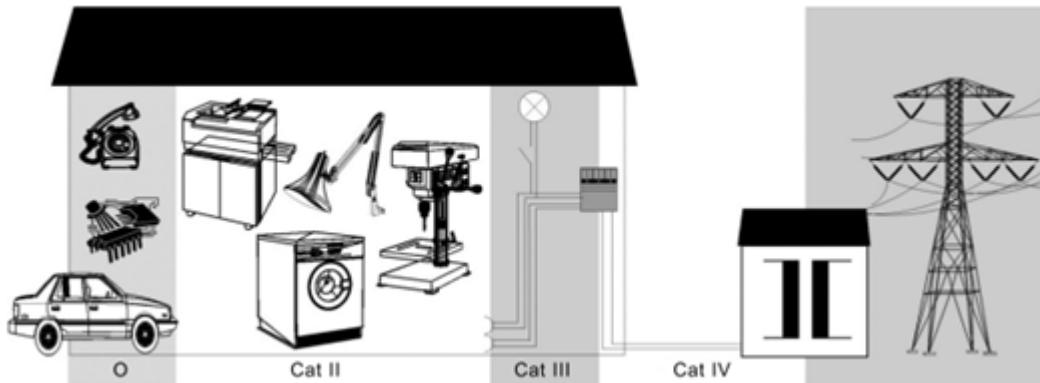

SHS800X Measurement Category

SHS800X can working under the measurement category listed in the table below, The applicable measurement category of a combination of a probe assembly and an accessory is the lower of the measurement category.

SHS800X	Max Input Voltage
Scope (BNC input)	CAT II 300Vrms Between BNC Signal and Protecting Earth. CAT II 30Vrms Between BNC GND and Protecting Earth. CAT II 300Vrms Between BNC Signal and BNC GND.
Scope (Probe input)	CAT II 300Vrms Between Signal and Protecting Earth. CAT II 30Vrms Between Probe GND and Protecting Earth. CAT II 300Vrms Between Probe Signal and Probe GND.

Multimeter	CAT III 300Vrms, CATII 600Vrms.
SCD10A ^[1]	CAT III 60Vrms.
SCD600MA ^[1]	CAT III 60Vrms.

Note: SCD10A is a 10A current adapter for the meter using to measure a current up to 10A, SCD600MA is a 600mA current adapter for the meter using to measure a current up to 600mA. Refer to the DCI/ACI chapter for more information.

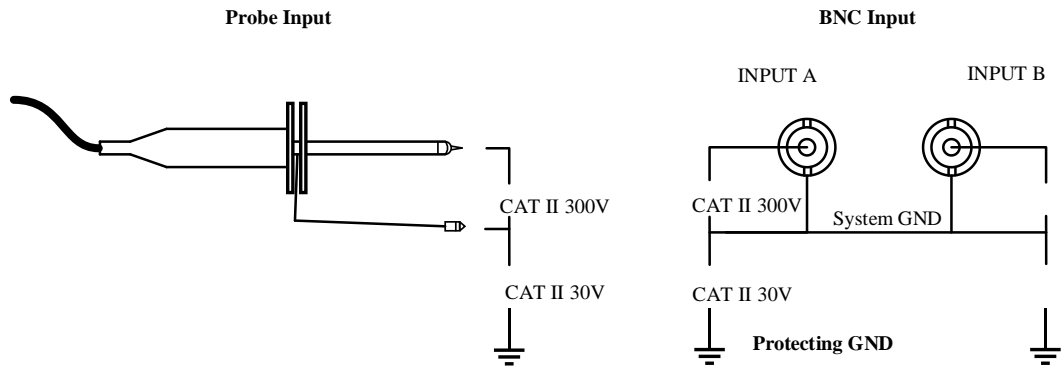

Measurement Category for SHS800X Scope

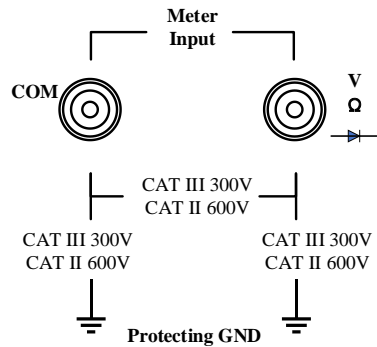

Measurement Category for SHS800X Multimeter



WARNING

Electrical Shock Hazard!

The reference ground of SHS800X CH1 and CH2 are connected together, connected one of them to the voltage higher than 30Vrms and touch the other one may results in personal injury.

Risque de choc électrique !

Les masses de référence du SHS800X CH1 et CH2 sont connectées ensemble, connectées l'une d'elles à une tension supérieure à 30 Vrms et toucher l'autre peut entraîner des blessures.

SHS1000X Measurement Category

SHS1000X can working under the measurement category listed in the table below The applicable measurement category of a combination of a probe assembly and an accessory is the lower of the measurement category.

SHS1000X	Max Input Voltage
Scope (BNC input)	CAT III 600Vrms/CAT II 1000Vrms Between BNC Signal and Protecting Earth. CAT III 600Vrms/CAT II 1000Vrms Between BNC GND and Protecting Earth. CAT III 300Vrms Between BNC Signal and BNC GND.
Scope (Probe input)	CAT III 600Vrms, CAT II 1000Vrms.
Multimeter	CAT III 600Vrms, CAT II 1000Vrms.
SCD10A ^[1]	CAT III 60Vrms.
SCD600MA ^[1]	CAT III 60Vrms.

Note: SCD10A is a 10A current adapter for the meter using to measure a current up to 10A, SCD600MA is a 600mA current adapter for the meter using to measure a current up to 600mA. Refer to the DCI/ACI chapter for more information.

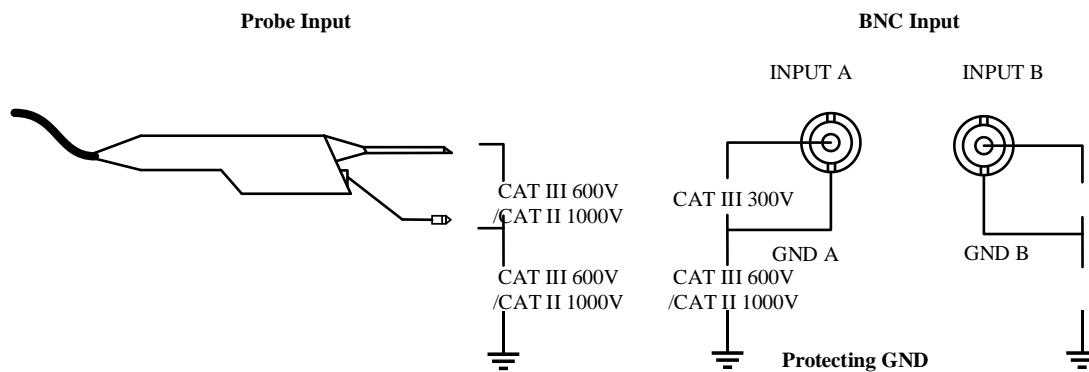

Measurement Category for SHS1000X Scope

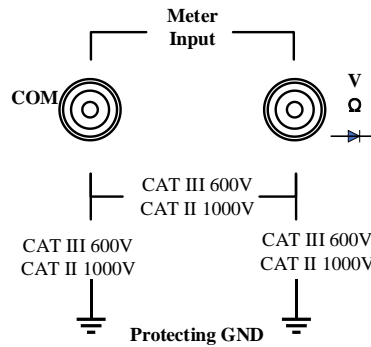

Measurement Category for SHS1000X Multimeter

Working Environment

General requirement

Environment

This product is intended for indoor use and should be operated in a clean, dry environment.

It can be stored in an environment with a waterproof/dustproof rating better than IP51.

Temperature

Operating: 0°C to +40°C

Non-operation: -20°C to +60°C

Note: Direct sunlight, radiators, and other heat sources should be taken into account when assessing the ambient temperature.

Humidity

Operating: 85% RH, 40 °C, 24 hours

Non-operating: 85% RH, 65 °C, 24 hours

Altitude

Operating: less than 2 Km

Non-operation: less than 5 Km

Installation (overvoltage) Category

This product is powered by mains conforming to installation (overvoltage) category II.



WARNING

Make sure that no overvoltage (such as that caused by thunderbolt) can reach the product, or else the operator might expose to danger of electric shock.

Assurez-vous qu'aucune surtension (comme celle causée par la foudre) ne

peut atteindre le produit, sinon l'opérateur pourrait s'exposer à un risque de choc électrique.

Installation (overvoltage) Category Definitions

Installation (overvoltage) category I refers to signal level which is applicable to equipment measurement terminals connected to the source circuit. In these terminals, precautions are done to limit the transient voltage to the corresponding low level.

Installation (overvoltage) category II refers to the local power distribution level which is applicable to equipment connected to the AC line (AC power).

Degree of Pollution

The oscilloscopes may be operated in environments of Pollution Degree II.

Note: Degree of Pollution II refers to a working environment which is dry and non-conductive pollution occurs. Occasional temporary conductivity caused by condensation is expected.

IP Rating

IP51 (as defined in IEC 60529).

Ventilation Requirement

Please make sure that the air intake and exhaust areas are free from obstructions and have free air. When using the oscilloscope in a bench-top or rack setting, provide at least 10 cm clearance beside, above and behind the instrument for adequate ventilation.



WARNING

Inadequate ventilation may cause temperature increase which would damage the instrument. So please keep the instrument well ventilated during operation.

Une ventilation inadéquate peut entraîner une augmentation de la température qui endommagerait l'instrument. Veuillez donc garder l'instrument bien ventilé pendant le fonctionnement.

AC Power Requirement

The power adapter operates with a single-phase, 100 to 240 Vrms (+/-10%) AC power at 50/60 Hz (+/-5%).

No manual voltage selection is required because the instrument automatically adapts to line voltage.

Depending on the type and number of options and accessories (probes, PC port plug-in, charging etc.), When powered by adapter, the scope can consume up to 35 W of power.

Note: The power adapter automatically adapts to the AC line input within the following ranges:

Voltage Range:	90 - 264 Vrms
Frequency Range:	47 - 63 Hz

Please use the power cord and adapter provided by the manufacturer. Use of other non-designated products may cause personal injury.



WARNING

Electrical Shock Hazard!

Use of an adapter or power supply not specified by the manufacturer may cause personal injury.

Risque de choc électrique !

L'utilisation d'un adaptateur ou d'un bloc d'alimentation non spécifié par le fabricant peut entraîner des blessures.

To make the oscilloscope completely power off, unplug the instrument power cord from the AC socket and remove the battery from the scope.

The battery should be removed from the scope when it is not to be used for an extended period of time.

Maintenance and Services

Only authorized and specially trained personnel can open the oscilloscope. When performing maintenance operations on the oscilloscope, you must remove the power adapter and make sure that the oscilloscope is turned off, otherwise it may cause an internal short circuit of the oscilloscope.

Adjustment, replacement of parts, maintenance and repair can only be performed by operators authorized by SIGLENT Technology. Safety-related parts can only be replaced with original parts. Safety tests must be carried out after replacing parts.

Document Overview

This manual introduces how to use the digital oscilloscope in details.

Quick Start	Provide information about preparations before using the instrument and a brief introduction of the instrument.
Vertical System	Introduce the functions of the vertical system of the oscilloscope.
Horizontal System	Introduce the functions of the horizontal system of the oscilloscope.
Acquisition System	Introduce the functions of the sample system of the oscilloscope.
Trigger	Introduce the trigger mode, trigger coupling, trigger hold off, external trigger and various trigger types of the oscilloscope.
Serial Trigger and Decode	Introduce the functions of the serial trigger and decode.
Reference Waveform	Introduce how to save and display REF waveform.
Math	Introduce the math operation function of the oscilloscope.
Cursors	Introduce how to use cursors to make measurements.
Measure	Introduce how to measure the waveform parameters.
Display	Introduce how to set the display of the oscilloscope.
Save and Recall	Introduce how to save and recall the measurement result and the setting of the oscilloscope.
System Setting	Introduce how to set the system setup.
Search	Introduce the oscilloscope search function
Navigate	Introduce how to use the waveform navigation function of the oscilloscope
History	Introduce how to use and set historical waveform functions.
Meter	Introduce how to use meter function.
Recorder	Introduce how to use recorder function.

Table of Content

Copyright and Declaration	II
Introduction	III
General Safety Summary	IV
Precautions for Operation.....	IV
Safety Terms and Symbols.....	IV
Safety Operation Matters	V
Safety of Electricity.....	VI
Safety Transportation Matters.....	II
Battery Usage	II
Waste Disposal	III
Safety Compliance	III
General Care and Cleaning	III
Measurement Category	IV
SHS800X Measurement Category	V
SHS1000X Measurement Category	VII
Working Environment	VIII
General requirement	VIII
Ventilation Requirement.....	IX
AC Power Requirement	I
Maintenance and Services	II
Document Overview	XXIV
Quick Start	2
Appearance and Dimensions	3
Prepare for Using	4
Adjust the Supporting Leg	4
Battery Installation	4
Connect the Power Supply.....	5
Power-on Inspection	6
Connect the Probe	6
Function Inspection	6
Probe Compensation.....	8
Multimeter Meter Pen.....	8
Front Panel Overview	9
Side Panel Overview	10
Rear Panel Overview	11
Front Panel Function Overview	12
Horizontal	12
Vertical.....	13
Trigger	14
Run Control	15
Universal Knob	16
Other Buttons	17

Help	19
User Interface	20
Vertical System	22
Enable the Channel	23
Adjust Scale	24
Vertical Position	25
Coupling	25
Bandwidth Limit	26
Probe	26
Unit	27
Deskew	27
Invert	27
Trace Visible/Hidden	28
Horizontal System	29
Horizontal Scale	30
Horizontal Delay	31
Roll Mode	32
Zoom Mode	33
Acquisition System	35
Overview	36
Sampling Theory	36
Sample Rate	36
Bandwidth and Sample Rate	37
Memory Depth	39
Sampling Mode	40
Interpolation Method	41
Acquisition Mode	44
Normal	44
Peak Detect	45
Average	46
ERES	48
Horizontal Format	49
Sequence Mode	51
Trigger	53
Trigger Source	55
Trigger Mode	56
Trigger Level	58
Trigger Coupling	59
Trigger Holdoff	60
Noise Rejection	61
Trigger Type	63
Edge Trigger	64
Slope Trigger	66
Pulse Trigger	68

Video Trigger	70
Window Trigger.....	74
Interval Trigger.....	77
Dropout Trigger.....	79
Runt Trigger	82
Pattern Trigger	84
Serial Trigger and Decode	86
I2C Trigger and Serial Decode	87
Setup for I2C Signals.....	87
I2C Trigger	88
I2C Serial Decode	92
SPI Trigger and Serial Decode	94
Setup for SPI Signals.....	94
SPI Trigger.....	98
SPI Serial Decode	99
UART Trigger and Serial Decode	101
Setup for UART Signals	101
UART Trigger.....	103
UART Serial Decode	104
CAN Trigger and Serial Decode	106
Setup for CAN Signals	106
CAN Trigger.....	107
CAN Serial Decode	108
LIN Trigger and Serial Decode	110
Setup for LIN Signals	110
LIN Trigger	111
LIN Serial Decode	112
Reference Waveform	114
Save REF Waveform to Internal Memory	115
Display REF Waveform.....	115
Adjust REF Waveform	116
Clear REF Waveform.....	117
Math	118
Units for Math Waveforms	119
Math Operators.....	120
Addition or Subtraction.....	120
Multiplication and Division	122
FFT Operation	123
Math Function Operation	129
Cursors	134
X Cursors.....	134
Y Cursors.....	134
Make Cursor Measurements	136
Measure	138

Type of Measurement.....	139
Voltage Measurements.....	139
Time Measurements.....	141
Delay Measurements.....	142
Add Measurement.....	143
Clear Measurement.....	146
All Measurement.....	146
Gate Measurement.....	148
Display	149
Display Type.....	150
Color Grade.....	151
Persistence.....	152
Clear Display.....	153
Grid Type.....	154
Intensity.....	154
Grid Brightness.....	155
Transparence.....	155
LCD Light.....	155
Save and Recall	157
Save Type.....	158
Internal Save and Recall.....	160
External save and recall.....	160
Disk Management.....	163
Create a New File or Folder.....	164
Delete a File or Folder.....	165
Rename a File or Folder.....	165
System Setting	166
View System Status.....	167
Do Self Cal.....	168
Quick-Cal.....	169
Sound.....	169
Language.....	169
Update Firmware and Configuration.....	169
Do Self-Test.....	171
Screen Test.....	171
Keyboard Test.....	172
LED Test.....	173
Screen Saver.....	174
Date/Time.....	175
Set Date/Time.....	175
Set Time Zone.....	176
Reference Position.....	177
Search	178
Setting.....	178

Results	179
Navigate	181
Time Navigate	181
History Frame Navigate	181
Search Event Navigate	182
History	183
Meter	184
DCV/ACV	186
Resistance	188
Diode	189
Continuity	190
Capacitance	191
DCI/ACI	192
Recorder	194
Sample Logger	194
Measure Logger	199
Factory Setup	205
Troubleshooting	206

Quick Start

This chapter introduces the preparations when using the oscilloscope for the first time, the front panel, rear panel, and the oscilloscope's user interface .

The contents of this chapter:

- ◆ General Inspection
- ◆ Appearance and Dimensions
- ◆ Prepare for Using
- ◆ Front Panel Overview
- ◆ Side Panel Overview
- ◆ Rear Panel Overview
- ◆ Front Panel Function Overview
- ◆ Help
- ◆ User Interface

Appearance and Dimensions

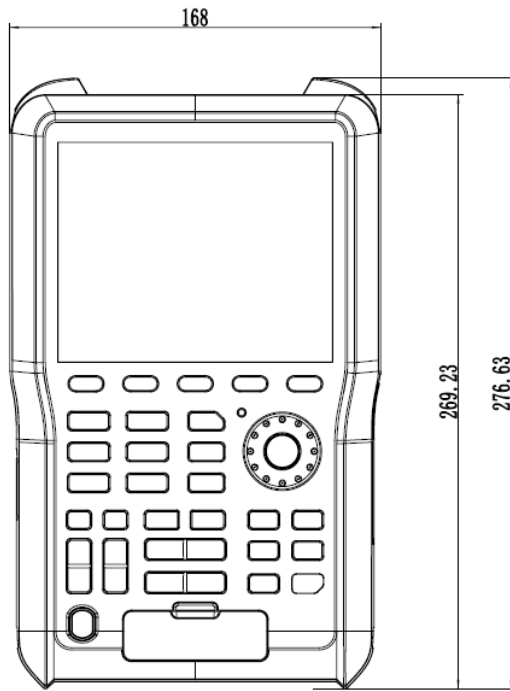

Figure 1 Front View

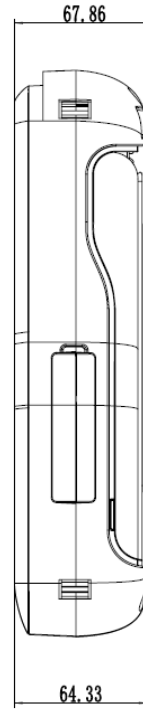

Figure 2 Side view

Prepare for Using

Adjust the Supporting Leg

Properly adjust the supporting leg and place the oscilloscope steadily for better operation and observation of the display screen.



Figure 3 Adjust the Supporting Leg

Battery Installation

When the oscilloscope leaves the factory, the battery and the host are separated. Please install the battery as follows:

1. Remove the three screws on the battery cover with a screwdriver, as shown in Figure 4.
2. Remove the battery cover, as shown in Figure 5.
3. Put the battery into the battery slot and close the battery cover, as shown in Figure 6.
4. Lock the screws with the screwdriver, as shown in Figure 4, and then turn on the oscilloscope to check whether the battery is installed successfully.



Figure 4



Figure 5



Figure 6

Important tips:

- Pay attention to the direction of the battery cover, with the serial number at the bottom.
- Anti-reverse connection design is adopted for battery slot. Please put the battery in gently, do not use force.
- If the battery fails to power on after successful installation, it may be that the battery has run out. Please charge it in time.
- When the oscilloscope is idle, the battery needs to be charged every 3 months .

Connect the Power Supply

The power requirements of the oscilloscope is 100-240 V, 50/60Hz. Please use the power cord provided to connect the oscilloscope to the power source.



Figure 7 Connect to Power Supply

Power-on Inspection

When the oscilloscope is energized, press the power key at the lower-left corner of the front panel to start the oscilloscope. During the start-up process, the oscilloscope performs a series of self-tests and you can hear the sound of relay switching. After the self-test is finished, the welcome screen will be displayed.

Connect the Probe

Connect the Probe:

1. Connect the BNC terminal of the probe to a channel BNC connector.
2. Connect the probe tip to the circuit point to be tested and connect the ground alligator clip of the probe to the circuit ground terminal.

Function Inspection

1. Press the **Default** button on the front panel to restore the instrument to its default configuration.
2. Connect the ground alligator clip of the probe to the “Ground Terminal”

- under the probe compensation signal output terminal.
- Use the probe to connect the input terminal of CH1 of the oscilloscope and the "Compensation Signal Output Terminal" of the probe.
 - Press the **Auto Setup**.
 - Observe the waveform on the display. In normal condition, the display should be a square waveform as shown in the figure below:

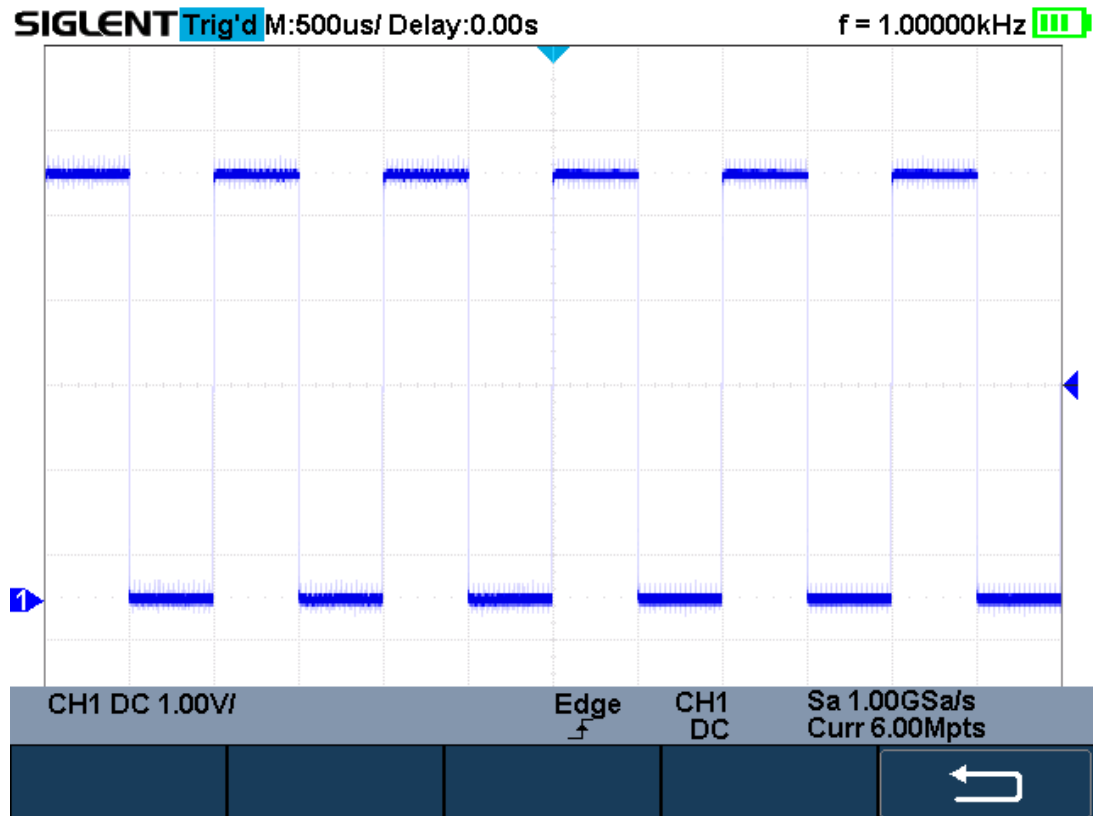

Figure 8 Function Inspection

- Use the same method to test the other channels. If the square waveforms shown do not match that in the figure above, please perform "Probe Compensation" in the next section.

WARNING

To avoid electric shock during the use of probe, please make sure that the insulated wire of the probe is in good condition and do not touch the metallic part of the probe when the probe is connected to high voltage source

Pour éviter les chocs électriques lors de l'utilisation de la sonde, veuillez vous assurer que le fil isolé de la sonde est en bon état et ne touchez pas la partie métallique de la sonde lorsque la sonde est connectée à une source haute tension

Probe Compensation

When the probes are used for the first time, you should compensate the probes to match the input channels of the oscilloscope. Non-compensated or poorly compensated probes may cause measurement inaccuracy or error. The probe compensation procedures are as follows.

1. Set the switch to 10X on the probe.
2. Perform steps 1, 2, 3 and 4 of “Function Inspection” in the previous section.
3. Check the waveforms displayed and compare them with the following:

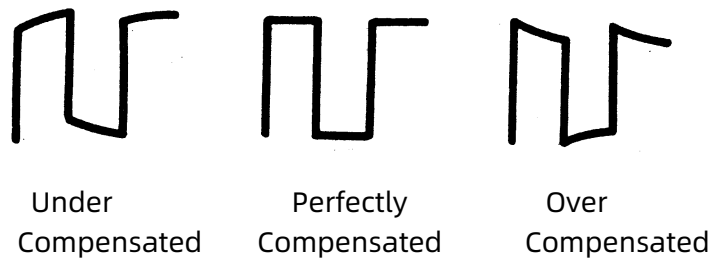

4. Use a nonmetallic driver to adjust the low-frequency compensation adjustment hole on the probe until the waveform displayed is as the “Perfectly compensated” in the figure above.

Multimeter Meter Pen

To avoid obtaining no measurements or unnecessary damage to the SHS800X/SHS1000X, you should use the right jack when measuring current, voltage and other measurement.

Front Panel Overview



Figure 9 Scope Front Panel Overview

No.	Description	No.	Description
1	Power Button	7	Universal Knob
2	Vertical Control	8	Trigger Control
3	Dual Function Button	9	Horizontal Control
4	Menu Soft key	10	Single Function Button
5	LCD Display	11	Multimeter Input
6	Analog Channel Input		

Side Panel Overview



Figure 10 Scope Side Panel Overview

- 1. Probe Compensation/ Ground Terminal**
Supplies a 0-5 V, 1 kHz square wave for compensating the probes.
- 2. USB Host**
Connect the USB host ports to USB storage devices for data transfer.
- 3. USB Device**
The oscilloscope support SCPI remote control commands, user can control the oscilloscope through this interface.
- 4. Adapter Power Input**

Rear Panel Overview



Figure 11 Scope Rear Panel Overview

1. Battery Cover

2. Supporting Leg

Adjust the supporting leg properly to use them as stands to tilt the oscilloscope upwards for stable placement of the oscilloscope as well as better operation and observation.

3. Handle

Front Panel Function Overview

Horizontal



Horizontal Position Button: adjust horizontal position. Press the button to change the horizontal delay time, waveforms of all channels will move horizontally with the trigger point. Press the **Shift** + **Horizontal Position** to quickly reset the horizontal delay to Zero.

Horizontal Scale Button: adjust the horizontal time base. Press **ns** to reduce the time base and press **S** to increase the time base. During the modification, waveforms of all the channels will be displayed in expanded or compressed mode and the time base message at the upper-left side of the screen would change accordingly.

Vertical





CH1 : Analog input channels. The two channels are marked by different colors which are also used to mark both the corresponding waveforms on the screen and the channel input connectors.

Vertical Position Button: adjust the vertical position of the current channel waveform. Press up to increase the position and down to decrease. During the modification, the waveform would move up and down and the position message at the lower-left corner of the screen would change accordingly. Press **Shift** + **Vertical Position** to quickly reset the vertical position to zero.

Vertical Scale Button: adjust the vertical scale of the current channel. Press **mV** to decrease the scale and press **V** to increase. During the modification, the amplitude of the waveform would enlarge or reduce and the scale information in the channel setup box would change accordingly.

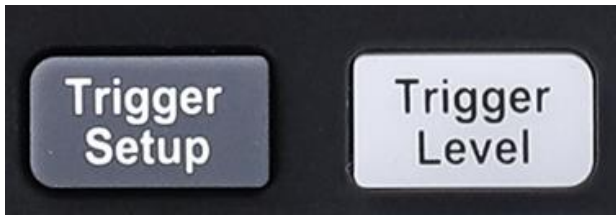
Trigger



 : press the button to enter the TRIGGER function menu. The oscilloscope provides abundant advanced trigger functions.

 : press the button and then turn the **Universal Knob** to adjust the trigger level. During the modification, the trigger level line would move up and down. Press down the **Universal Knob** to quickly reset the trigger level to center of the waveform.

Run Control

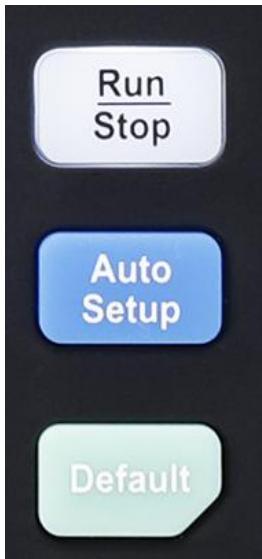

press the button to set the acquisition state to Run or Stop. In RUN state, the key is illuminated in yellow. In STOP state, the key is illuminated in red.



press the button to enable the waveform auto setting function. The oscilloscope will automatically adjust the vertical scale, horizontal time base and trigger mode according to the input signal to realize optimum waveform display.



Press the button to reset the oscilloscope to user default setup.

Universal Knob



- 1. Adjust the waveform intensity.**
You can press the **Display/Persist** button; press the **Next Page** soft key to go to the second page of the DISPLAY function menu; press the **Intensity** soft key and then turn the **Universal Knob** to adjust the waveform intensity.
- 2. Select the desired submenu.**
In menu operation, press any menu soft key and turn the **Universal Knob** to select the desired submenu under the menu and push down the knob to confirm the current submenu. Turn clockwise to up the intensity and counterclockwise to down.
- 3. Modify parameters.**
After having chosen a parameter, turn the **Universal Knob** to modify the value. Turn clockwise to increase the intensity and counterclockwise to reduce. In addition, it can also be used to adjust scale and offset of MATH and REF.
- 4. Choose file or directory or input filename.**
After having entered the file system, turn the **Universal Knob** to select the desired file or directory. When inputting filename, turn the **Universal Knob** to select the desired character and the push the knob to confirm.

Other Buttons

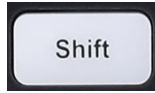

Function switching button

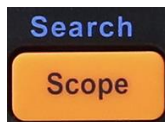

Press the button to enter scope mode.

Press **Shift** and this button to enter the SEARCH function menu.

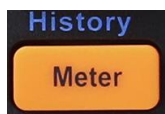

Press the button to enter meter mode.

Press the button to enter the history mode. In history mode, it can record most 80,000 frames waveforms.

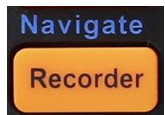

Press the button to enter recorder mode.

Press the button to turn off or turn on the navigate function.

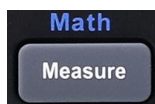

Press the button to enable/disable measurements.

Press **Shift** and this button to enable/disable MATH function.



Press to enter the CURSOR function menu. The oscilloscope provides manual and track cursor mode.

Press **Shift** and this button to enter the SAVE/RECALL function menu.

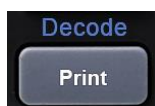

Press the button to perform a screenshot save to an external storage device. The supported format includes .bmp\ .jpg\ .png.

Press **Shift** and this button to enter the DECODE function menu. The oscilloscope supports I2C, SPI, UART, CAN and LIN serial bus decode.



Press the button to turn on/off menu display.

Press **Shift** and this button to enter the REF function menu.

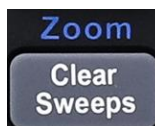

Clears the data or display in multiple sweeps, including display persistence, measurement statistics, average sweeps and Pass/Fail statistics.

Press **Shift** and this button to enter zoom mode.

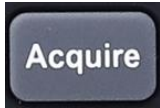

Press the button to enter the ACQUIRE function menu to set the acquisition mode, memory depth, wave interpolation and so on.



Press the button to enter the DISPLAY menu. The second press turn on Persist, press the button again to turn off Persist.

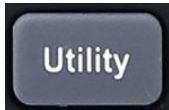

Press to enter the UTILITY function menu to look at the system status, do self-calibration, set the sound, language and so on.

Help

The oscilloscope has an on line help function that supplies multi-language help information.

You can access the help function by pressing any button for 2 seconds and a help window will explain the function. Also all of the submenus include help information.

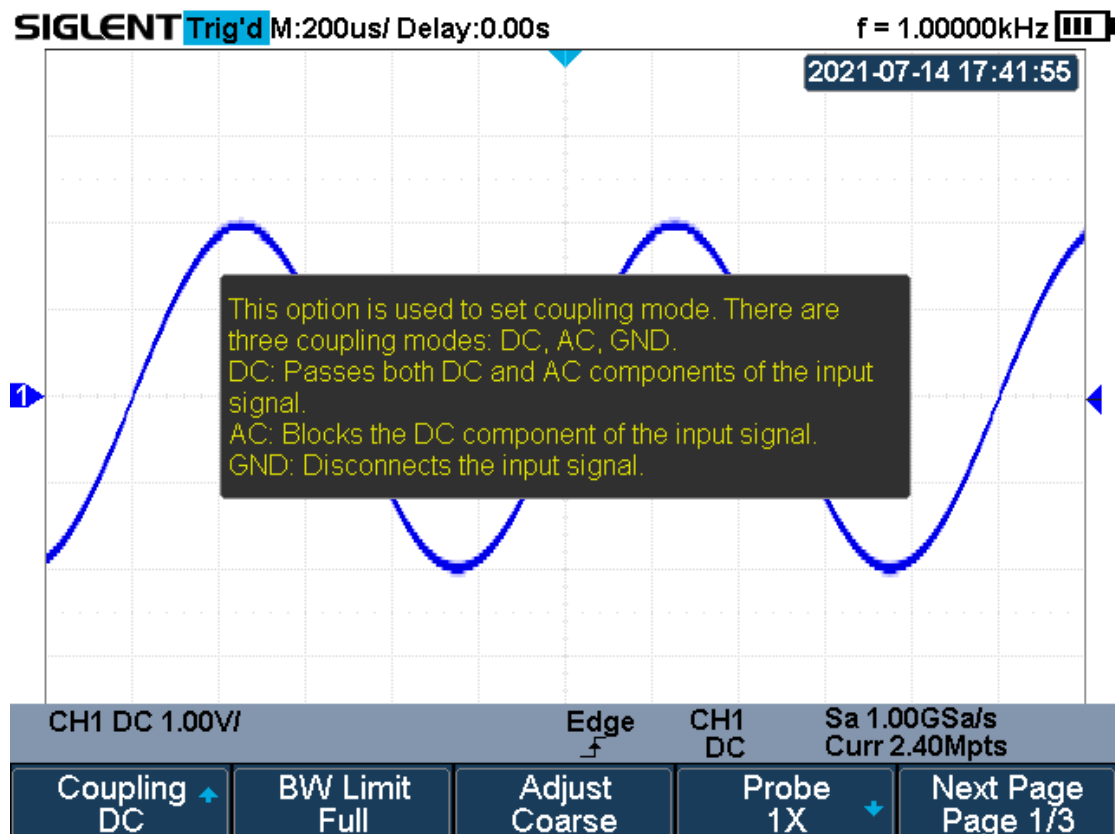

Figure 12 Help Message

User Interface

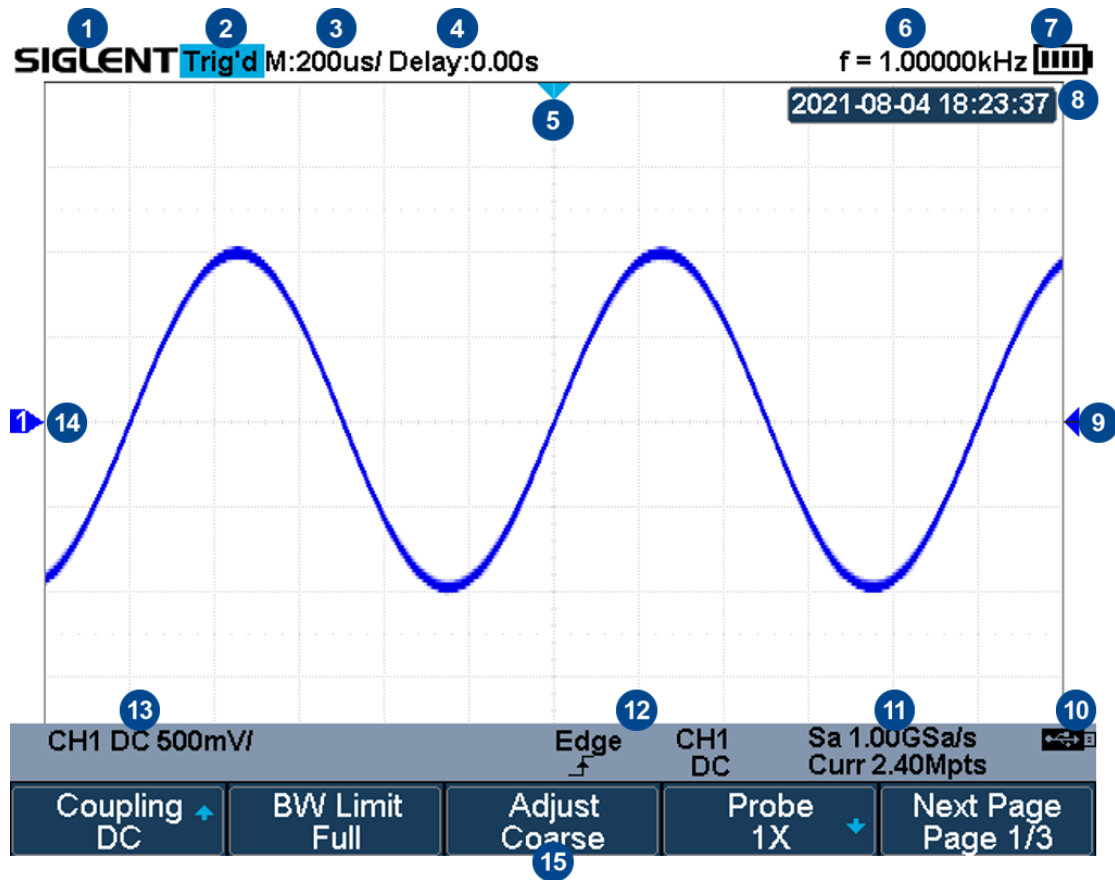









Figure 13 User Interface

1. **Product Logo**
SIGLENT is the registered trademark of SIGLENT TECHNOLOGIES CO., LTD.
2. **Acquisition Status**
Available trigger status includes Arm, Ready, Trig'd, Auto, Stop, FStop, Roll.
3. **Horizontal Time Base**
 - Represent the time per grid on the horizontal axis on the screen.
 - Use the **Horizontal Scale** button to adjust the parameter. The available range is from 1.0 ns to 100 s.
4. **Horizontal Position (Delay)**
Turn the **Horizontal Position** button to adjust the parameter. Press the **Shift** and **Horizontal Position** button to set the value to 0 automatically.

5. **Trigger Delay Label**
Indicate the trigger delay on the waveform.
6. **Frequency Counter**
Display the frequency value of the trigger channel.
7. **Battery Level**
8. **Date/Time**
9. **Trigger Level Label**
Display the position of trigger level, the color is the same to the trigger channel. It can move from +4.5div to -4.5div of the screen center.
10. **I/O status**
 Indicate that the USB Host is connected.
11. **Sampling Rate/ Memory Depth**
Display the current sampling rate and memory depth. Sa means the current sampling rate and Curr means the current memory depth.
12. **Trigger Setup**
 -  Trigger Type: display the current trigger type. The trigger type names display by the abbreviation when the name is too long to display.
 -  Trigger source: display the currently trigger source.
 -  Trigger condition: display the current trigger condition.
 -  Trigger coupling: display the current trigger coupling. Available trigger coupling mode: DC, AC, HF Reject, LF Reject.
13. **Channel Setup**
 -  Channel coupling: display the current channel coupling of the channel. Channel coupling that available: DC, AC, and GND.
 -  Vertical Scale: display the current vertical scale of the channel. Press the **Vertical Scale** button to adjust the value.
14. **Channel Label/Waveform**
Different channels are marked by different colors and the color of the waveform complies with the color of the channel.
15. **Menu**
Display the corresponding function menu of the selected button. Press the corresponding soft key to set the oscilloscope.

Vertical System

This chapter introduces how to set the vertical system of the oscilloscope.

The contents of this chapter:

- ◆ Enable the Channel
- ◆ Adjust Scale
- ◆ Vertical Position
- ◆ Coupling
- ◆ Bandwidth Limit
- ◆ Probe
- ◆ Unit
- ◆ Deskew
- ◆ Invert
- ◆ Trace Visible/Hidden

Enable the Channel

The SHS800X/SHS1000X provides 2 analog input channels and each channel shares the same vertical control system. Since the vertical system setting methods of each channel is the same, this chapter uses CH1 as an example to introduce the setting method of the vertical system.

Connect the signal to the CH1 channel connector; and then press the **CH1** button in the vertical control area (VERTICAL) on the front panel to enable CH1.

The channel setting menu and the channel information bar are displayed at the bottom of the screen.

After the channel is turned on, modify the parameters such as the vertical scale, the horizontal time base and the trigger mode according to the input signal to make the waveform display easy to observe and measure.

Note: to turn off the channel, press the channel button twice.

Adjust Scale

The vertical scale can be adjusted in **Coarse** or **Fine** mode.

- **Coarse** adjustment (take counterclockwise as an example): set the vertical scale in 1-2-5 step namely 2 mV/div, 5 mV/div, 10 mV/div ...10 V/div.
Fine adjustment: further adjust the vertical scale within a relatively smaller range to improve vertical resolution. For example: 2 V/div, 1.98V/div, 1.96V/div, 1.94 V/div ...1 V/div.
- If the amplitude of the input waveform is a little bit greater than the full scale under the current scale and the amplitude would be a little bit lower if the next scale is used, fine adjustment can be used to improve the amplitude of waveform display to view signal details.

Press the **CH1** button on the front panel; then press the **Adjust** soft key to select the desired mode. Press the **Vertical Scale** button to adjust the vertical scale (**V** to increase the scale and **mV** to reduce).

The scale information in the channel information bar at the bottom of the screen will change accordingly during the adjustment process. The adjustable range of the vertical scale is related to the probing ratio currently set. By default, the probe attenuation factor is 1X and the adjustable range of the vertical scale is from 2 mV/div to 100 V/div.

Vertical Position

Press the **Vertical Position** button to adjust the vertical position of the channel waveform. Press up to increase the vertical position and the channel waveform moves up, while press down to decrease the vertical position and the waveform moves down. Press the **Shift** and **Vertical Position** button to set the vertical position of the channel waveform to zero.

The table below shows the range of vertical positions according to the volt scale.

Volt Scale	Range of Vertical Position
2 mV/div ~ 296 mV/div	±5 V
302 mV/div ~ 7.5 V/div	±80 V
7.6 V/div ~ 100 V/div	±400 V

Coupling

Set the coupling mode to filter out the undesired signals. For example, the signal under test is a square waveform with DC offset.

- When the coupling mode is set to **DC**: the DC and AC components of the signal under test can both pass through the channel.
- When the coupling mode is set to **AC**: the DC components of the signal under test are blocked.
- When the coupling mode is set to **GND**: the DC and AC components of the signal under test are both blocked.

Press the **CH1** button on the front panel; then press the **Coupling** softkey and turn the **Universal Knob** to select the desired coupling mode. The default setup is **DC**.

The current coupling mode is displayed in the channel information bar at the bottom of the screen. You can also press the **Coupling** softkey continuously to switch the coupling mode.

Bandwidth Limit

Set the bandwidth limit to reduce display noise. For example, the signal under test is a pulse with high frequency oscillation.

- When the bandwidth limit is set to **Full**, the high frequency components of the signal under test can pass through the channel.
- When the bandwidth limit is set to **20M**, the high frequency components that exceed 20 MHz will be attenuated.

Press the **CH1** button on the front panel; then press the **BW Limit** softkey to select **Full** or **20M**. The default setup is **Full**. When the bandwidth limit is enabled, the character **B** will be displayed in the channel information bar at the bottom of the screen.

Probe

Set the probe attenuation factor to match the type of the probe that you are using to ensure correct vertical readouts.

Press the **CH1** button on the front panel; then press the **Probe** softkey and turn the **Universal Knob** to select the desired value, and push the knob to confirm. The default setup is **1X**.

You can also continuously press the **Probe** softkey to switch the probe attenuation factor.

The table shows the probe attenuation factor

Menu	Attenuation Factor
0.1X	0.1 : 1
0.2X	0.2 : 1
0.5X	0.5 : 1
1X	1 : 1
2X	2 : 1
...	...
5000X	5000 : 1
10000X	10000 : 1

Custom	1000000:1~0.000001:1
--------	----------------------

You can also customize the probe attenuation factor. Press the **Probe** softkey, select **Custom**, and then press the **Custom** softkey to select **Custom** or **Custom Fine**. First, select **Custom** and turn the **Universal Knob** to achieve rough adjustment; and then select **Custom Fine** and turn the **Universal Knob** to achieve fine adjustment.

Unit

Select the amplitude display unit for the current channel. The available units are **V** and **A**. When the unit is changed, the unit displayed in the channel information bar will change accordingly.

1. Press **CH1** button on the front panel to enter the CH1 function menu.
2. Press the **Next Page** softkey to enter the second page of the CH1 function menu.
3. Press the **Unit** softkey to select the desired unit **V** or **A**.

The default setup is **V**.

Deskew

The valid range of each analog channel is $\pm 100\text{ns}$.

1. Press **CH1** button on the front panel to enter the CH1 function menu.
2. Press the **Next Page** softkey to enter the second page of the CH1 function menu.
3. Press the **Deskew** softkey. Then turn the **Universal Knob** to change deskew.

Invert

When **Invert** is set to **On**, the voltage values of the displayed waveform are inverted. Invert affects how a channel is displayed while it keeps the trigger

settings.

Inverting a channel also changes the result of any math function selected and measure function.

1. Press **CH1** button on the front panel to enter the CH1 function menu.
2. Press the **Next Page** softkey to enter the second page of the CH1 function menu.
3. Press the **Invert** softkey to turn on or off the invert display.

Trace Visible/Hidden

Set whether to hide the current channel waveform

1. Press **CH1** button on the front panel to enter the CH1 function menu.
2. Press the **Next Page** softkey to enter the third page of the CH1 function menu.
3. Press the **Trace** softkey to show or hide the channel waveform

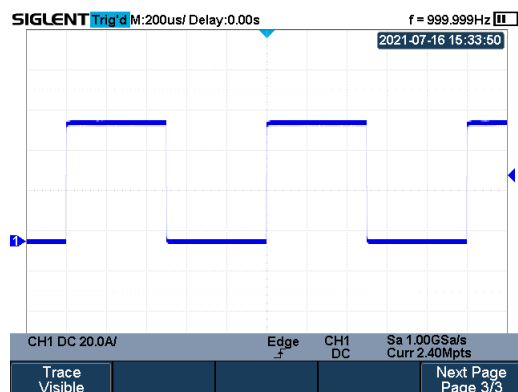

Trace Visible

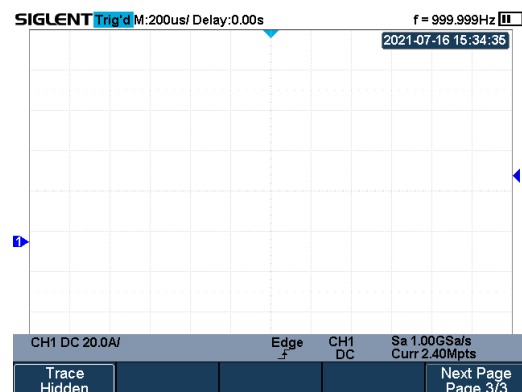

Trace Hidden

Horizontal System

This chapter introduces how to set the horizontal system of the oscilloscope.

The contents of this chapter:

- ◆ Horizontal Scale
- ◆ Horizontal Delay
- ◆ Roll Mode
- ◆ Zoom Mode

Horizontal Scale

Press the **Horizontal Scale** button on the front panel to adjust the horizontal time base. Press the **ns** to decrease the horizontal time scale and press the **s** to increase.

The time base information at the upper left corner of the screen will change accordingly during the adjustment. The range of the SHS800X/SHS1000X horizontal scale is from 1ns/div to 100s/div.

The **Horizontal Scale** button works (in the Normal time mode) while acquisitions are running or when they are stopped. When in run mode, adjust the horizontal scale knob to change the sample rate. When stopped, adjust the horizontal scale knob to zoom in the acquired data.

Horizontal Delay

Press the **Horizontal Position** button on the front panel, the trigger point (solid inverted triangle) will move horizontally. The trigger point moves horizontally to the right when press **>**, while moves to left when press **<**. Press the **Shift** and **Horizontal Position** button to reset the trigger delay.

When changing the horizontal delay, the delay time displayed in the information bar at the top of the screen changes in real time, indicating the distance between the time reference point and the trigger point. The available delay range depends on the selected time/div and memory depth.

Roll Mode

Press the **Acquire** button to enter the acquire menu and press the **Roll Mode** softkey to enable the roll mode.

In Roll mode the waveform moves slowly across the screen from right to left. It only operates on time base settings of 50 ms/div or slower.

In Roll mode there is no trigger. The fixed reference point on the screen is the right edge of the screen and refers to the current moment in time. Events that have occurred are scrolled to the left of the reference point. Since there is no trigger, no pre-trigger information is available.

If you would like to stop the display in Roll mode, press the **Run/Stop** button. To clear the display or restart an acquisition in Roll mode, press the **Run/Stop** button again.

Use Roll mode on low- frequency waveforms to yield a display much like a strip chart recorder. It allows the waveform to roll across the display.

Zoom Mode

Zoom is a horizontally expanded version of the normal display. You can use Zoom to locate and horizontally expand part of the normal window for a more detailed (higher- resolution) analysis of signals.

Press the **Shift** and **Clear Sweep** button on the front panel to turn on the zoom function, and press the combination buttons again to turn off the function. When Zoom function is on, the display window split in half. The top half shows the main window and the bottom half displays a faster zoom window.

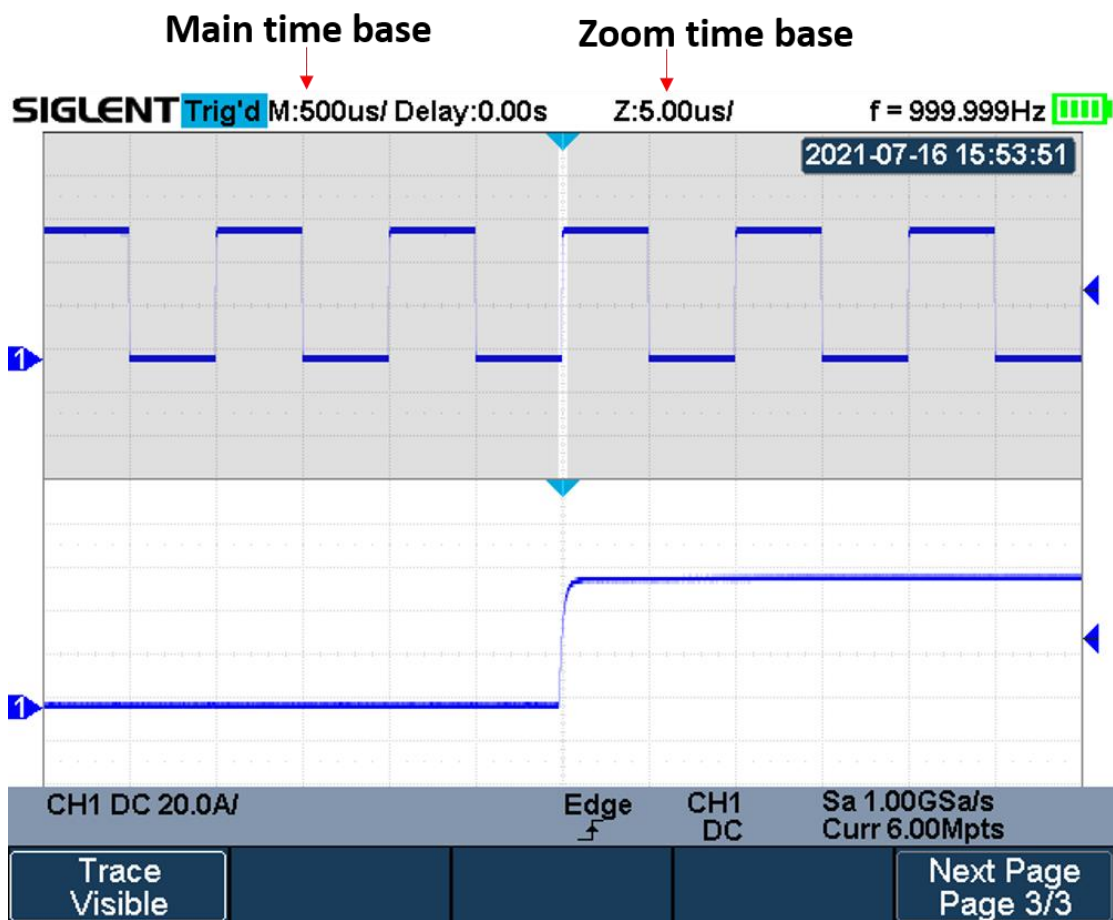

Figure 14 Split Screen Zoom

The extended normal window area is outlined with a border, and the rest of the normal window is ghosting. This border area in the normal window is zoomed to the lower half.

To change the time base for the Zoom window, press the **Horizontal Scale** button. The **Horizontal Scale** button controls the size of the border area. The **Horizontal**

Position button sets the left- to- right position of the zoom window. The delay value, which is the time displayed relative to the trigger point is momentarily displayed in the upper- right corner of the display when press the **Horizontal Position** button. Negative delay values indicate you're looking at a portion of the waveform before the trigger event, and positive values indicate you're looking at the waveform after the trigger event.

To change the time base of the normal window, turn off Zoom; then press the **Horizontal Scale** button.

Acquisition System

This chapter introduces how to use the acquisition control and set the sampling system of the oscilloscope.

The contents of this chapter:

- ◆ Overview
- ◆ Memory Depth
- ◆ Sampling Mode
- ◆ Interpolation Method
- ◆ Acquisition Mode
- ◆ Horizontal Format
- ◆ Sequence Mode

Overview

To understand the oscilloscope's sampling and acquisition modes, it is helpful to understand sampling theory, sample rate and oscilloscope bandwidth and sample rate.

Sampling Theory

The Nyquist sampling theorem states that for a limited bandwidth (band- limited) signal with maximum frequency f_{MAX} , the equally spaced sampling frequency f_s must be greater than twice the maximum frequency f_{MAX} , in order to uniquely reconstruct the signal without aliasing.

$$f_{MAX} = f_{s/2} = \text{Nyquist frequency } (f_N) = \text{folding frequency}$$

Sample Rate

The maximum sample rate of the oscilloscope is 1GSa/s. The actual sample rate of the oscilloscope is determined by the horizontal scale. Press the **Horizontal Scale Button** to adjust the sample rate.

The actual sample rate is displayed in the information area at the bottom right corner of the screen.

The effect of low sampling rate on the waveform:

1. **Waveform Distortion:** when the sample rate is too low, some waveform details are lost and the waveform displayed is quite different from the actual signal.

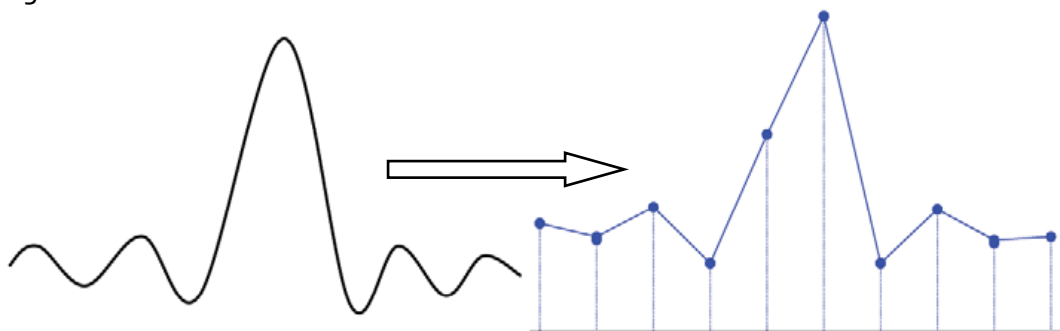

2. **Waveform Confusion:** when the sample rate is lower than twice the actual signal frequency (Nyquist Frequency), the waveform frequency reconstructed from the sample data is lower than the actual signal frequency. The most common aliasing is the jitter on fast edge.

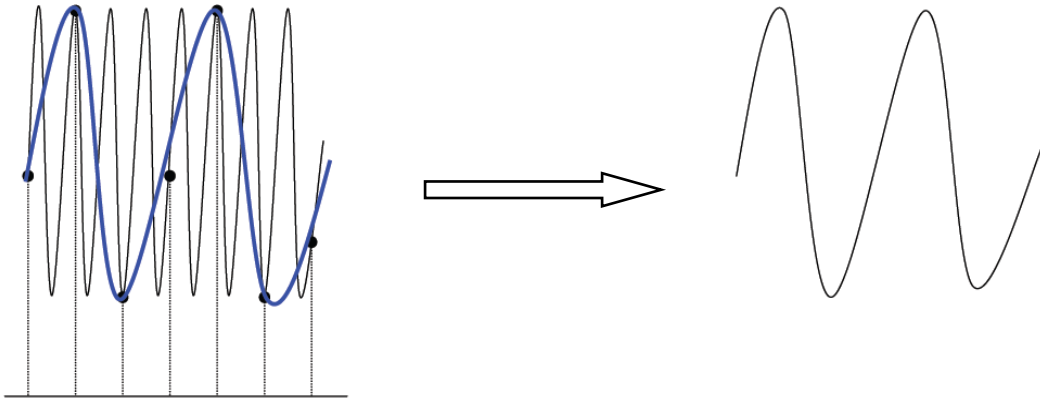

3. **Waveform Leakage:** when the sample rate is too low, the waveform reconstructed from the sample data cannot reflect all the actual signal information.

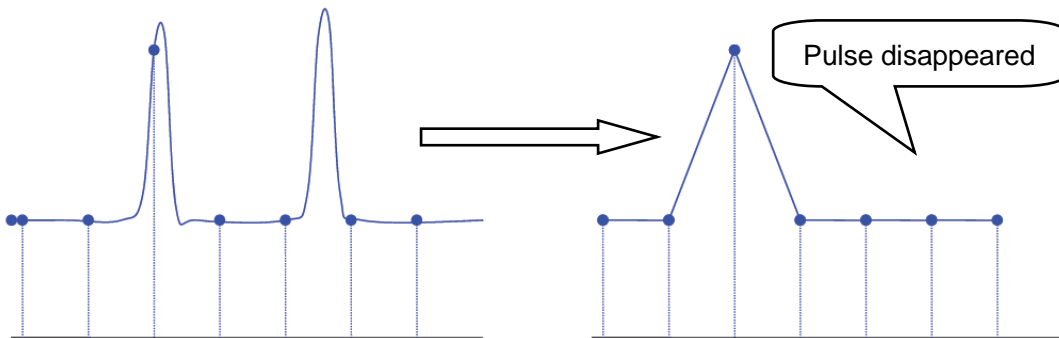

Bandwidth and Sample Rate

An oscilloscope's bandwidth is typically described as the lowest frequency at which the input sinusoidal signal is attenuated by 3 dB (- 30% amplitude error).

Under the bandwidth frequency, the required sampling rate is $f_s = 2f_{BW}$ according to the sampling theory. However, the theory assumes that there are no frequency components above f_{MAX} (f_{BW} in this case) in the system, which means that it requires a system with an ideal brick wall frequency response.

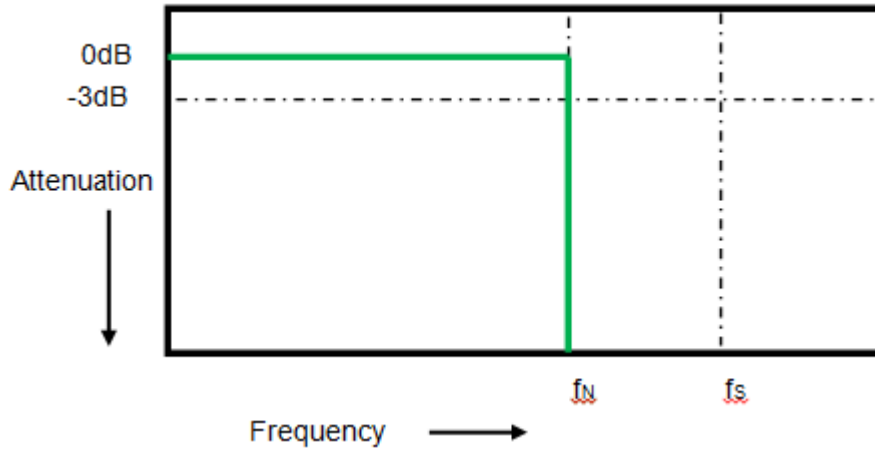

In fact, digital signals have frequency components above the fundamental frequency (a square wave is composed of a sine wave of the fundamental frequency and numerous odd harmonics), and generally, for oscilloscopes with a bandwidth of 500 MHz and below, the system has a Gaussian frequency response.

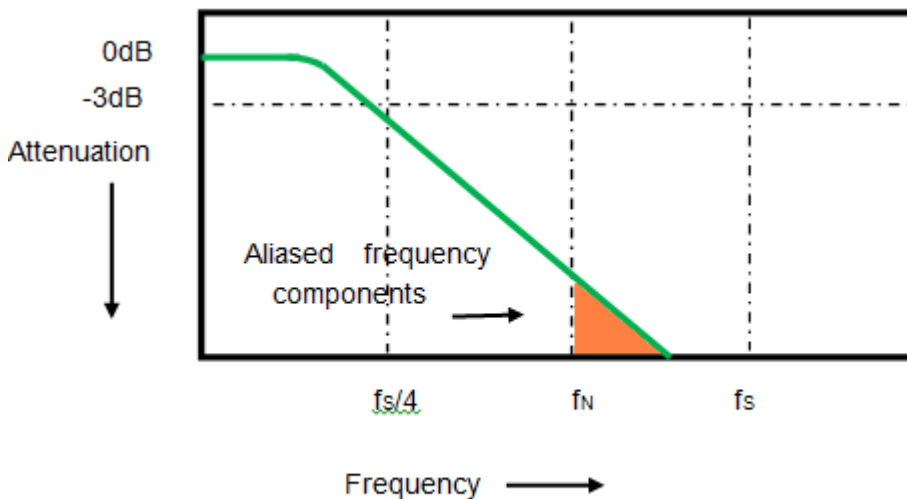

Limiting oscilloscope bandwidth (f_{BW}) to 1/4 the sample rate ($f_s/4$) reduces frequency components above the Nyquist frequency (f_N).

Therefore, the sampling frequency of the oscilloscope should be four or more times the bandwidth frequency: $f_s = 4f_{BW}$. In this way, there is less aliasing, and the components in the aliasing area are attenuated a lot.

Memory Depth

Memory depth refers to the number of waveform points that the oscilloscope can store in a single trigger sample and it reflects the storage ability of the sample memory.

Press the **Acquire** button on the front panel; press the **Mem Depth** softkey and then turn the **Universal Knob** to select the desired value and push down the knob to confirm. Press the **Mem Depth** softkey continually can also select the desired value.

The actual memory depth is displayed in the information area at the bottom right corner of the screen. Since the oscilloscope has two acquisition memories, when only one channel is on, the maximal memory depth is up to 12 Mpts.

The maximum storage depth in single channel mode is twice that in dual channel mode, as shown in the following table:

Single Channel Mode	Dual Channel Mode
12k	6k
120k	60k
1.2M	600k
12M	6M

The relation of memory depth, sample rate, and waveform length fulfills the equation below:

Memory depth = sample rate (Sa/s) × waveform length (s/div × div)

Sampling Mode

The oscilloscope only supports real-time sampling. In this mode, the oscilloscope samples and displays waveform within a trigger event. The maximum real-time sample rate is 1GSa/s.

Press the **Run/Stop** button to stop the sample, and the oscilloscope will hold the last display. At this point, you can still use the vertical control and horizontal control to pan and zoom the waveform.

Interpolation Method

Under real-time sampling, the oscilloscope acquires the discrete sample values of the waveform being displayed. In general, a waveform of dots display type is very difficult to observe. In order to increase the visibility of the signal, the digital oscilloscope usually uses the interpolation method to display a waveform.

The interpolation method is a processing method to “connect all the sampling points” , and using some points to calculate the whole appearance of the waveform. For real-time sampling interpolation method is used, even if the oscilloscope in a single captures only a small number of sampling points. The oscilloscope can use the interpolation method to fill out the gaps between points and reconstruct an accurate waveform.

Press the **Acquire** button on the front panel to enter the ACQUIRE Function menu; then press the **Interpolation** softkey to select **Sinx/x** or **X**.

- **X**: In the adjacent sample points are directly connected on a straight line. This method is only confined to rebuild on the edge of signals, such as a square wave.
- **Sinx/x**: Connecting the sampling points with curves has stronger versatility. Sinx interpolation method uses mathematical processing to calculate results in the actual sample interval. This method bending signal waveform, and make it produce a more realistic regular shape than pure square wave and pulse. When the sampling frequency is 3 to 5 times the bandwidth frequency of the system. Recommended Sinx/s interpolation method.

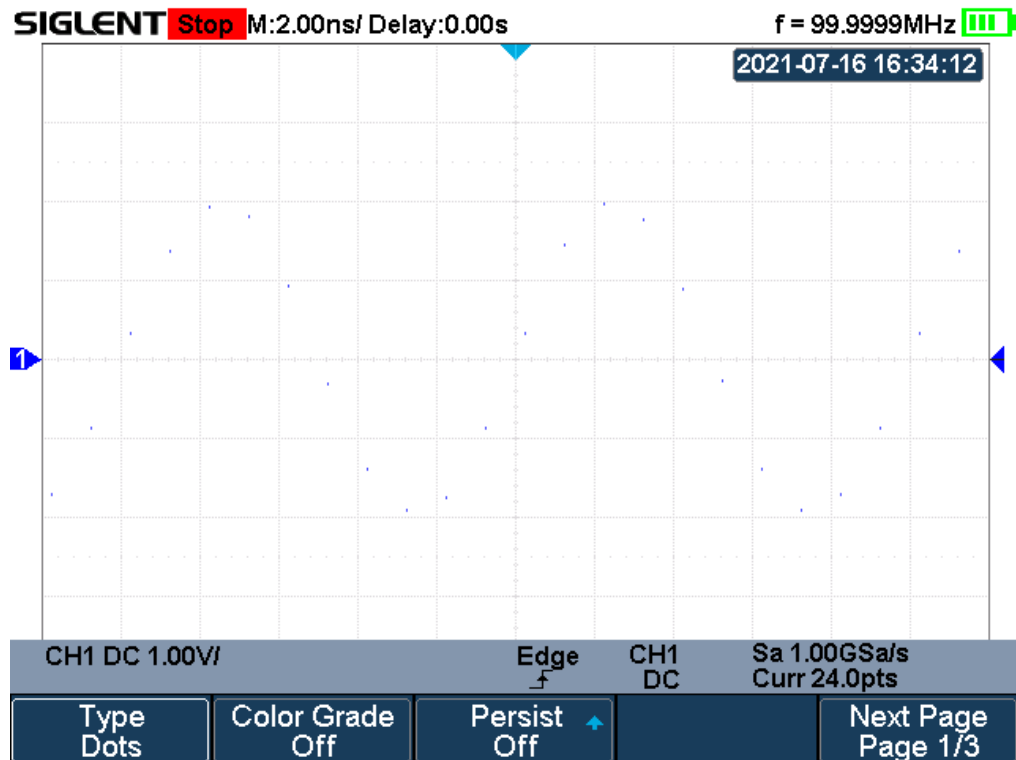

Figure 15 Display Type Set to Dots

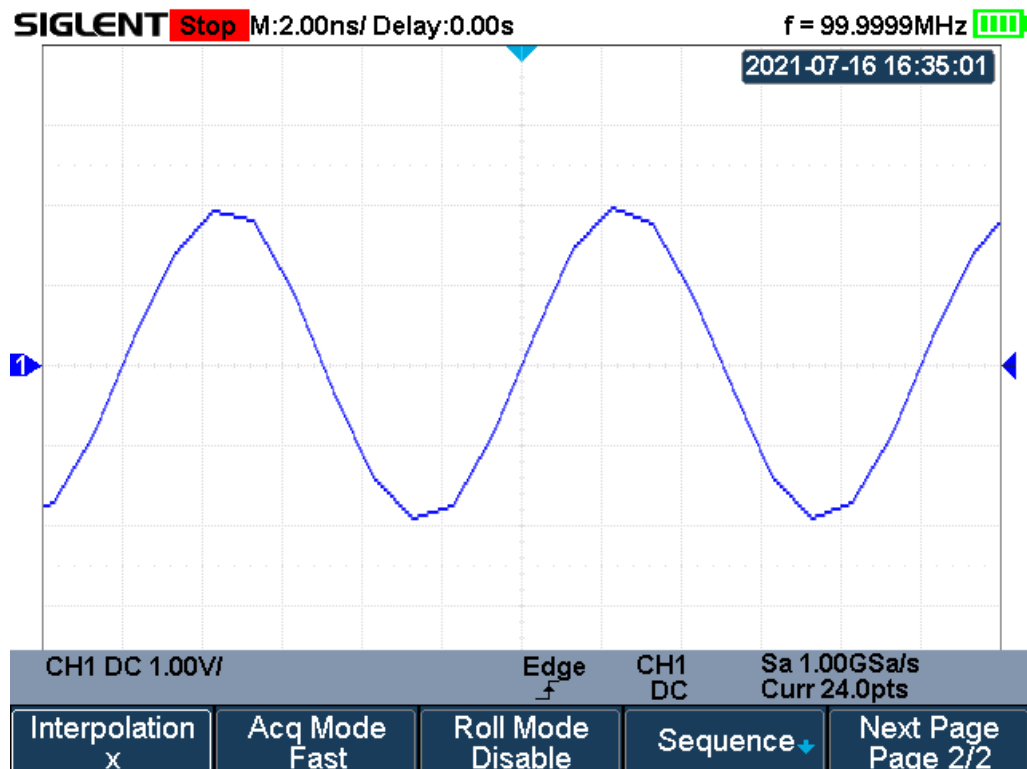

Figure 16 x Interpolation

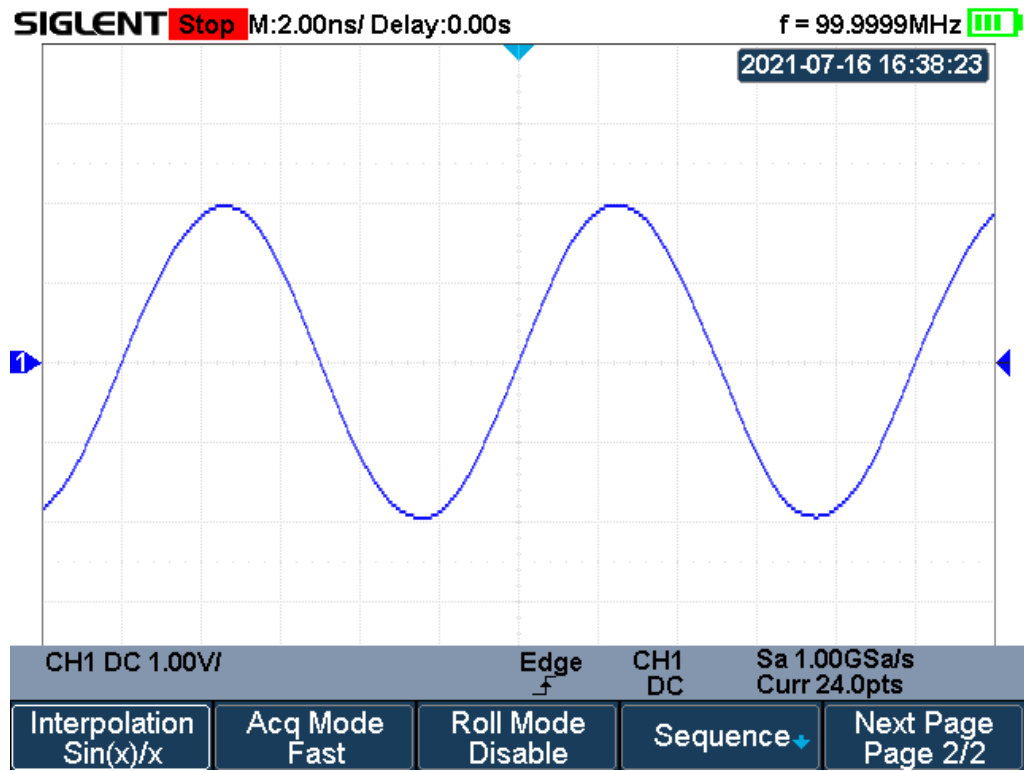

Figure 17 Sinx/x Interpolation

Acquisition Mode

The acquisition mode is used to control how to generate waveform points from sample points. The oscilloscope provides the following acquisition mode: Normal, Peak Detect, Average, and ERES.

1. Press the **Acquire** button on the front panel to enter the ACQUIRE function menu;
2. Press the **Acquisition** softkey; then turn the **Universal Knob** to select the desired acquisition mode and push down the knob to confirm. The default setup is **Normal**.

Normal

In this mode, the oscilloscope samples the signal at equal time intervals to rebuild the waveform. For most of the waveforms, the best display effect can be obtained using this mode. It is the default acquisition mode.

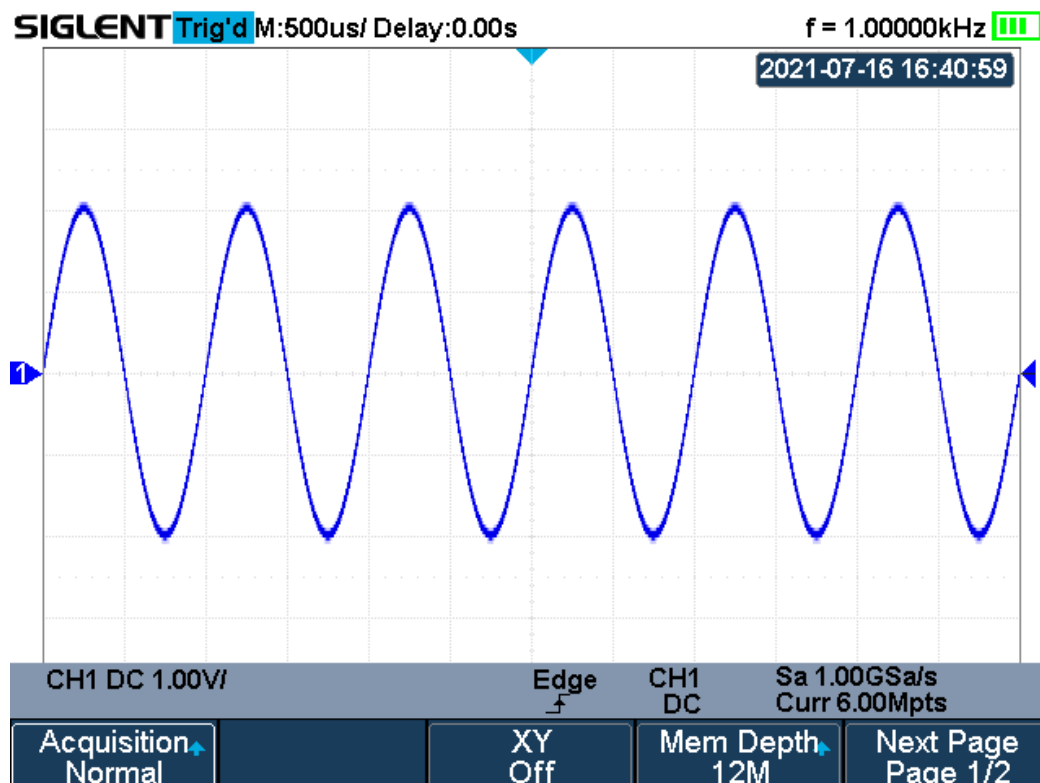

Figure 18 Acquisition System

Peak Detect

In this mode, the oscilloscope acquires the maximum and minimum values of the signal within the sample interval to get the signal's envelope or the narrow pulse of the signal that might be lost. In this mode, signal confusion can be prevented but the noise displayed would be larger.

In this mode, the oscilloscope can display all the pulses with pulse widths at least as wide as the sample period.

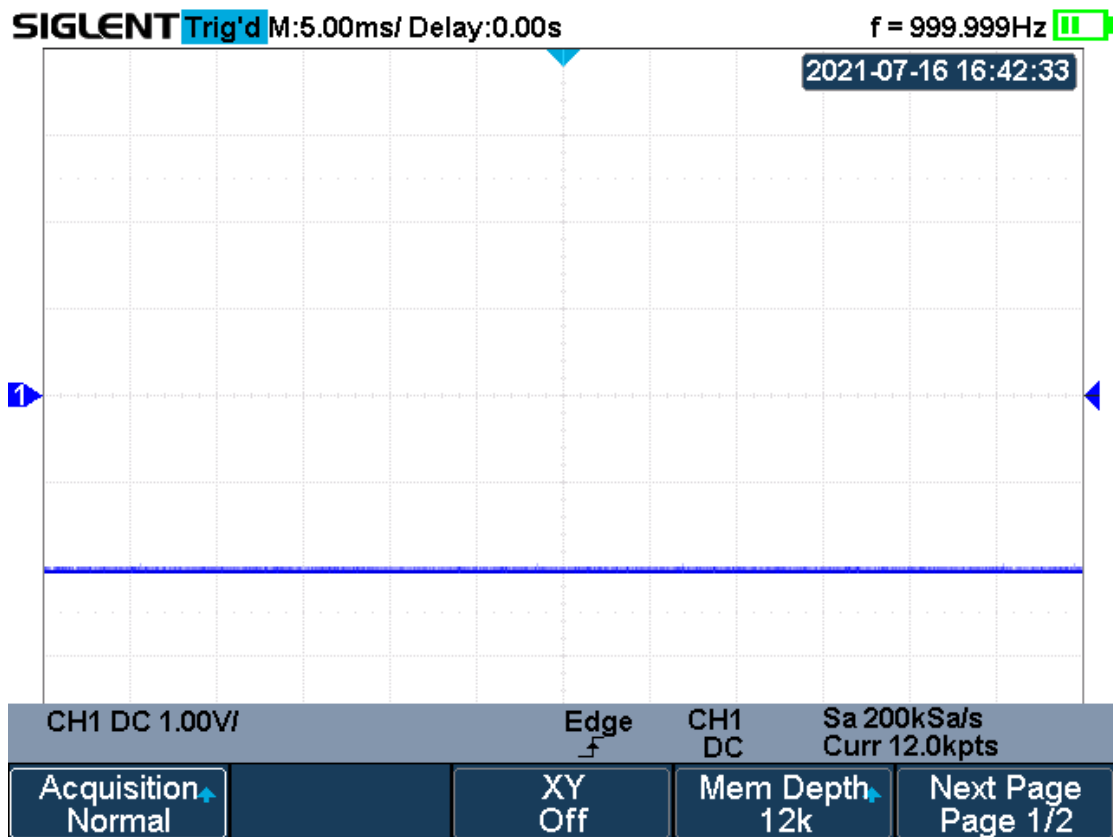

Figure 19 Pulse With 0.1% Duty, Normal Mode

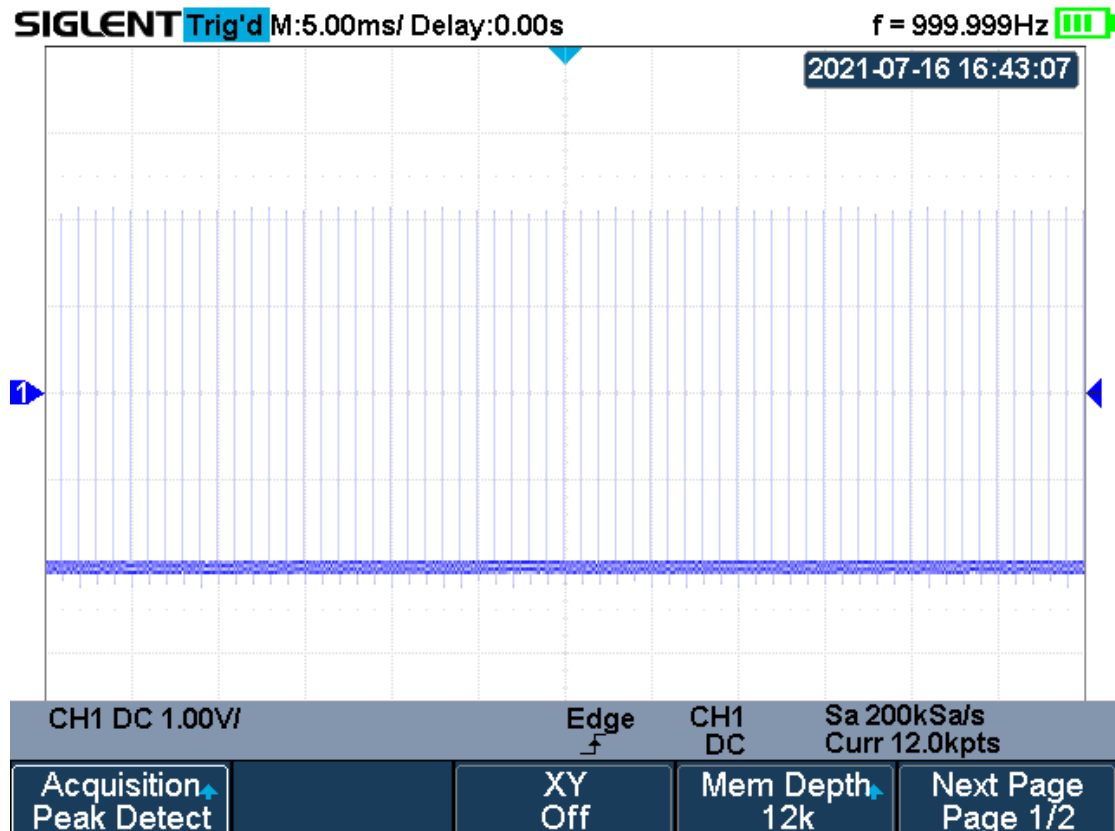

Figure 20 Pulse With 0.1% Duty, Peak Detect Mode

Average

In this mode, the oscilloscope averages the waveforms from multiple samples to reduce the random noise of the input signal and improve the vertical resolution. The greater the number of averages is, the lower the noise and the higher the vertical resolution will be. Still, the slower the response of the displayed waveform to the waveform changes will be.

The available range of averages is from 4 to 1024 and the default is 16. When Average mode is selected, press **Averages** and turn the **Universal knob** or press the softkey continually to set the desired average time.

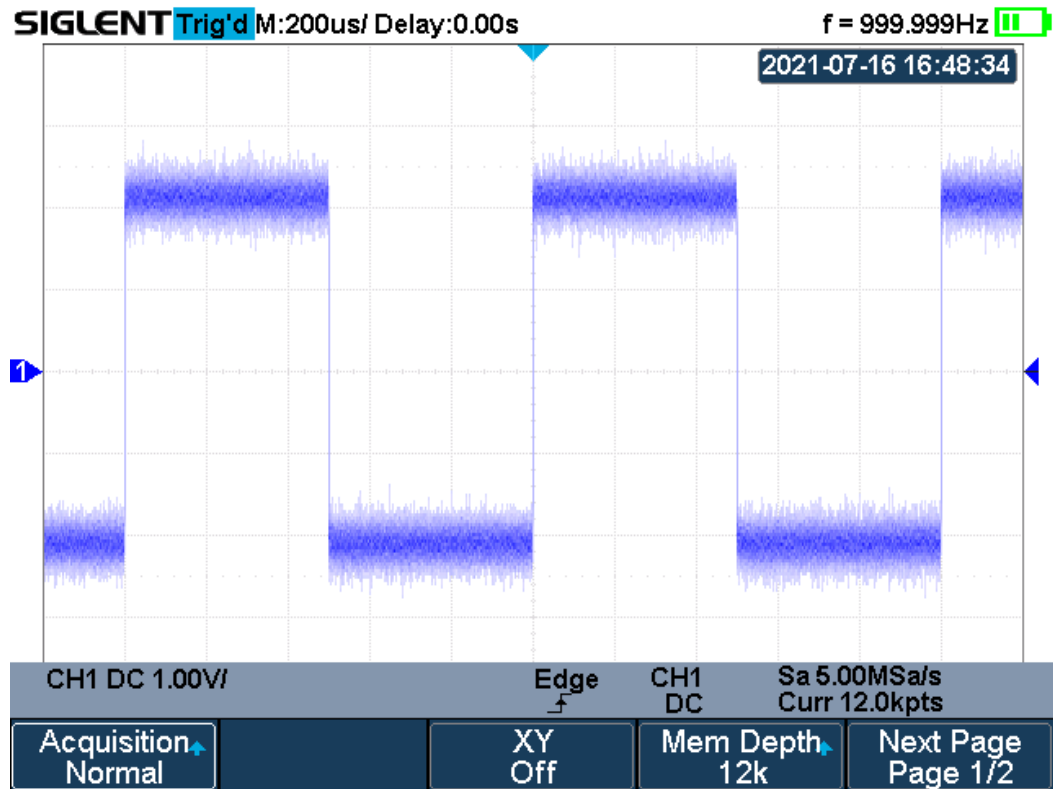

Figure 21 With Random Noise, Normal Mode

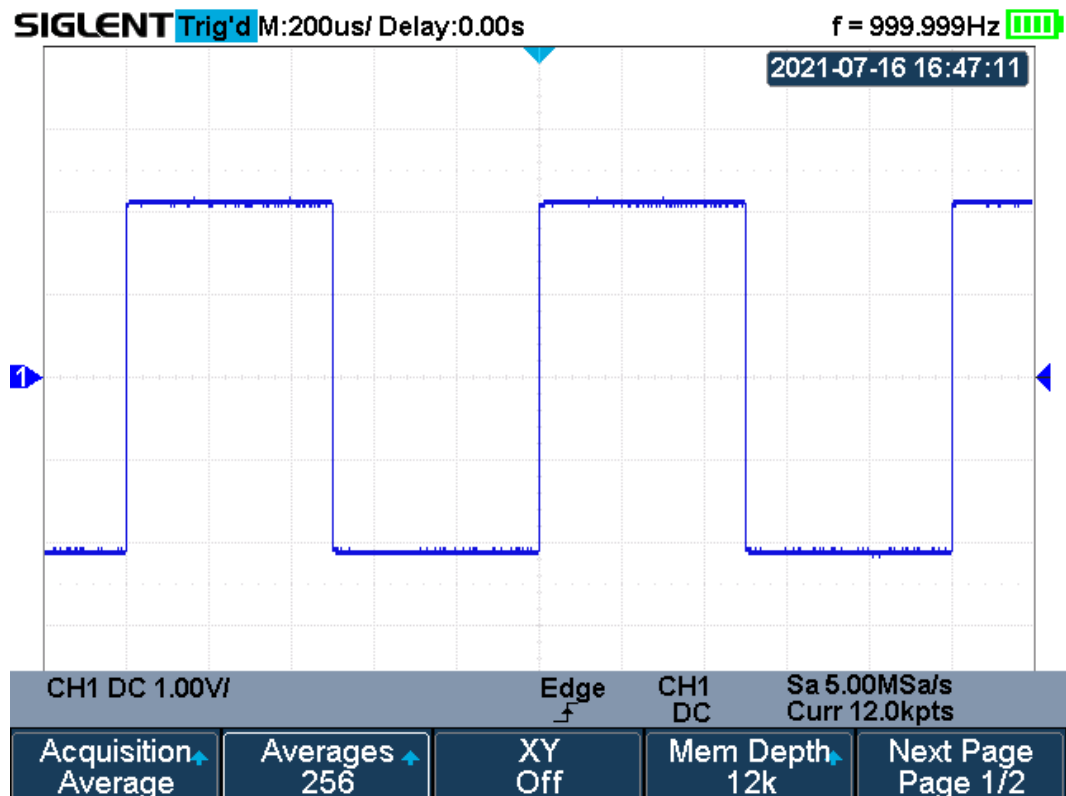

Figure 22 With Random Noise, Average Mode

ERES

This mode uses a kind of ultra-sample technique to average the neighboring points of the sample waveform to reduce the random noise on the input signal and generate much smoother waveforms on the screen. ERES mode is generally used when the sample rate of the digital converter is higher than the storage rate of the acquisition memory.

ERES mode can be used on single-shot and repetitive signals and does not slow waveform updates. This mode limits the oscilloscope's real-time bandwidth because it effectively acts like a low-pass filter.

Note: “Average” and “ERES” mode use different averaging methods. The former uses “Waveform Average” and the latter uses “Dot Average” .

Horizontal Format

Press the **Acquire** button on the front panel; then press the **XY** soft key to set the XY(On) or YT(Off) mode. The default setup is YT.

YT

It is the normal viewing mode for the oscilloscope. In the Normal time mode, signal events occurring before the trigger are plotted to the left of the trigger point and signal events after the trigger plotted to the right of the trigger point.

XY

XY mode changes the display from a volt- versus- time display to a volt- versus- volt display. Channel 1 amplitude is plotted on the X- axis and Channel 2 amplitude is plotted on the Y- axis, the two channels will be turned on or off together.

You can use XY mode to compare frequency and phase relationships between two signals. XY mode can also be used with transducers to display strain versus displacement, flow versus pressure, volts versus current, or voltage versus frequency.

The phase deviation between two signals with the same frequency can be easily measured via Lissajous method. The figure below shows the measurement schematic diagram of the phase deviation

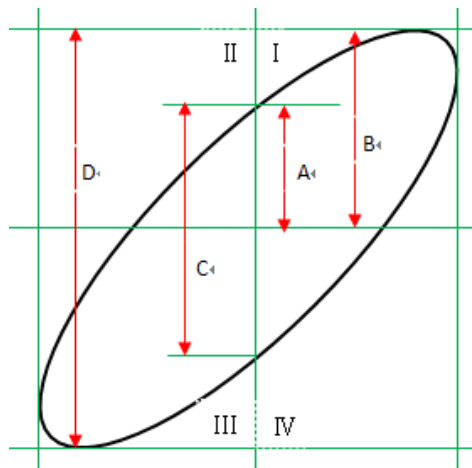

According to $\sin\theta=A/B$ or C/D (wherein, θ is the phase deviation angle between the two channels and the definitions of A, B, C, and D are as shown in the figure above), the phase deviation angle is obtained, that is: $\theta=\pm\arcsin(A/B)$ or $\pm\arcsin(C/D)$

If the principal axis of the ellipse is within quadrant I and III, the phase deviation angle obtained should be within quadrants I and IV, namely within $(0 \text{ to } \pi/2)$ or $(3\pi/2 \text{ to } 2\pi)$. Suppose the principal axis of the ellipse is within quadrant II and IV. In that case, the phase deviation angle obtained should be within quadrant II and III, namely within $(\pi/2 \text{ to } \pi)$ or $(\pi \text{ to } 3\pi/2)$.

The X-Y function can be used to measure the phase deviation that occurred when the signal under test passes through a circuit network. Connect the oscilloscope to the circuit to monitor the input and output signals of the circuit.

Sequence Mode

Sequence is also a kind of acquisition mode, which does not display waveform during the sampling process. It improves the waveform capture rate, and the maximal capture rate is 400,000 wfs/s. So it can capture the small probability event effectively.

The oscilloscope runs and fills a memory segment for each trigger event. The oscilloscope is busy acquiring multiple segments. The oscilloscope continues to trigger until memory is filled, and then display the waveforms on the screen.

To use the sequence mode, the HORIZONTAL Format must be set to **YT**.

Do the following steps to use the sequence mode.

1. Press the **Acquire** button on the front panel to enter the ACQUIRE function menu;
2. Press the **Sequence** softkey to enter the SEQUENCE function menu.



Figure 23 SEQUENCE Function Menu

3. Press the **Max. Segments** softkey; and then turn the **Universal Knob** to select the desired value.

Do the following steps to replay the sequence waveform under history mode:

1. Press the **Shift** and **Meter** button to enable HISTORY function.

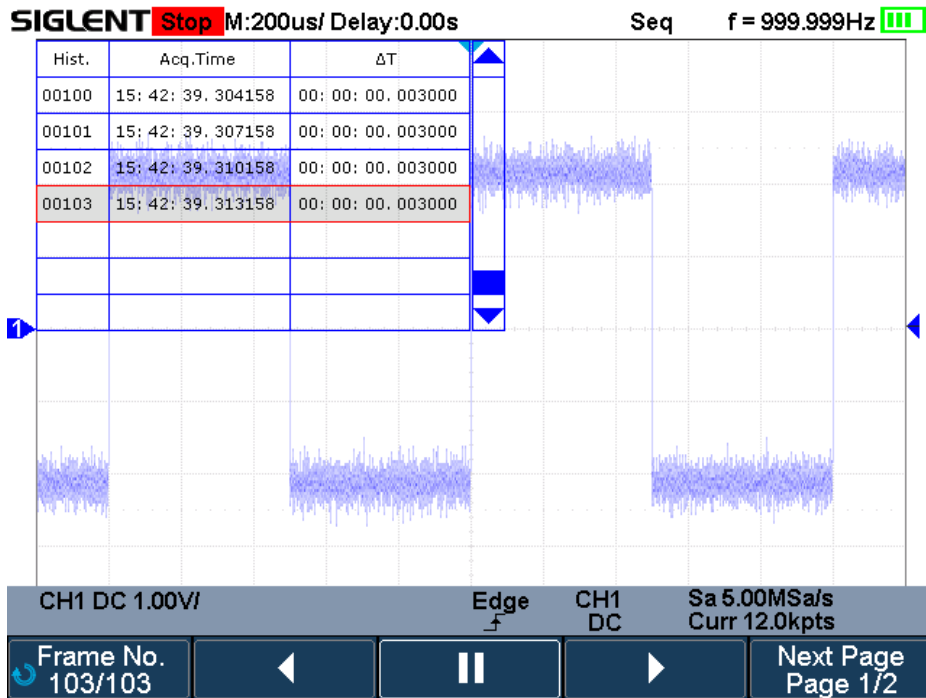





Figure 24 HISTORY Function Menu

2. Press the **List** softkey to turn on the list display. The list records the acquisition time of every frame and shows the frame number that displaying on the screen.
3. Press the **Frame No.** softkey; and then turn the **Universal Knob** to select the frame to display.
4. Press the  softkey to replay the waveform from the current frame to 1.
5. Press the  softkey to stop replay.
6. Press the  softkey to replay the waveform from the current frame to the last frame.

Trigger

For trigger, you set certain trigger condition according to the requirement. When a waveform in the waveform stream meets this condition, the oscilloscope captures this waveform and the neighboring part and displays them on the screen. Still, the digital oscilloscope displays waveform continuously no matter whether it is stably triggered, but only stable trigger can ensure stable display. The trigger circuit ensures that every time base sweep or acquisition starts from the input signal and the user-defined trigger condition. Every sweep is synchronous to the acquisition and the waveforms acquired overlap to display stable waveform.

The following is the schematic diagram of the acquisition memory. As shown in the figure below, the position of the trigger event is determined by the reference time point and the delay setting.

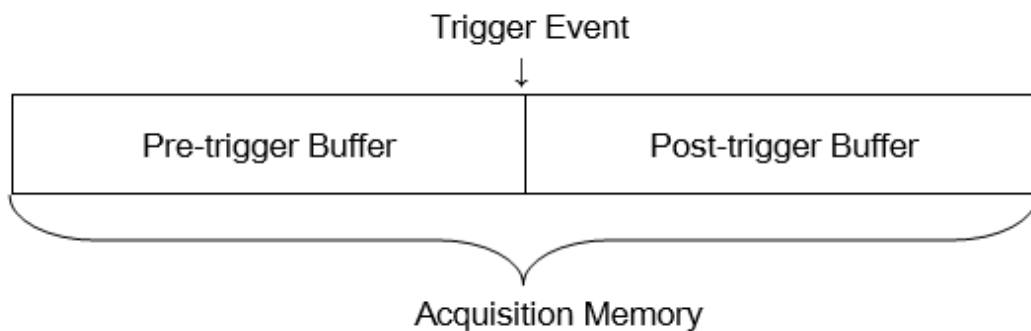

Trigger setting should be based on the features of the input signal, thus you need to have some knowledge of the signal under test to quickly capture the desired waveform.

The oscilloscope provides abundant advanced trigger functions which can help you to focus on the desired waveform details. These trigger types are edge, slope, pulse, video, window, interval, dropout, runt, pattern and serial trigger. This chapter will mainly introduce all these trigger functions mentioned above in detail and tell you how to set the trigger conditions to capture the desired waveform.

The contents of this chapter:

- ◆ Trigger Source
- ◆ Trigger Mode
- ◆ Trigger Level
- ◆ Trigger Coupling
- ◆ Trigger Holdoff
- ◆ Noise Rejection
- ◆ Trigger Type

Trigger Source

Press the **Trigger Setup** button on the front panel to enter the TRIGGER function menu; press the **Source** softkey and then turn the **Universal Knob** to select the desired trigger source.

The current trigger source is displayed at the bottom of the screen. Select channel with signal input as trigger source to obtain stable trigger.

Analog channel input:

Signals input from analog channels can all be used as the trigger source.

Note: to select stable channel waveform as the trigger source to stabilize the display.

Trigger Mode

The SHS800X/SHS1000X's trigger mode includes auto, normal, single and Force. Trigger mode affects how the oscilloscope searches for the trigger

After the oscilloscope starts running, the oscilloscope operates by first filling the pre-trigger buffer. It starts searching for a trigger after the pre-trigger buffer is filled and continues to flow data through this buffer while it searches for the trigger. While searching for the trigger, the oscilloscope overflows the pre-trigger buffer and the first data put into the buffer is first pushed out (First Input First Out, FIFO).

When a trigger is found, the pre- trigger buffer contains the events that occurred before the trigger. Then, the oscilloscope fills the post- trigger buffer and displays the acquisition memory.

Press the **Trigger Setup** button and **Mode** softkey to select the desired trigger mode.

- In the **Auto** trigger mode (the default setting), if the specified trigger conditions are not found, triggers are forced and acquisitions are made so that signal activity is displayed on the oscilloscope.

The **Auto** trigger mode is appropriate when:

- Checking DC signals or signals with unknown levels or activity.
- When trigger conditions occur often enough that forced triggers are unnecessary.

- In the **Normal** trigger mode, triggers and acquisitions only occur when the specified trigger conditions are found. Otherwise, the oscilloscope holds the original waveform and waits for the next trigger.

The **Normal** trigger mode is appropriate when:

- You only want to acquire specific events specified by the trigger settings.
- Triggering on an infrequent signal from a serial bus (for example, I2C, SPI, CAN, LIN, etc.) or another signal that arrives in bursts. The **Normal** trigger mode lets you stabilize the display by preventing the oscilloscope from auto- triggering.

- In the **Single** trigger mode, the oscilloscope waits for a trigger, displays the waveform when the trigger condition is met, and stops.

The **Single** trigger mode is appropriate when:

- To capture single event or a periodic signal.
 - To capture burst or other unusual signals.
- In the **Force** trigger mode, when the trigger condition is not met, it will be force triggered after the frame is acquired. The trigger status in the upper left corner of the screen will be displayed as "FStop".

Trigger Level

Trigger level and slope define the trigger point,

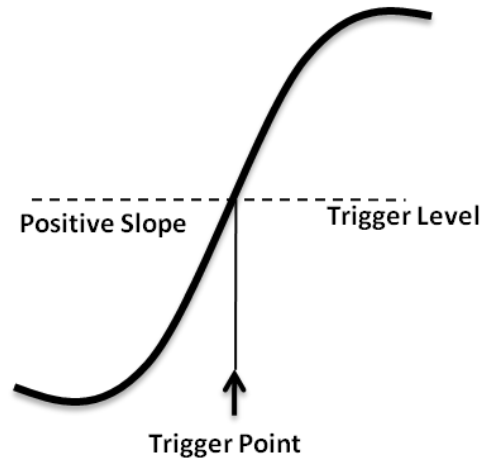

You can adjust the trigger level for a selected analog channel by pressing the **Trigger Level** button and turning the **Universal Knob**.

You can push the **Universal Knob** to set the level to the waveform's 50% value immediately. If AC coupling is used, pushing the **Universal Knob** sets the trigger level to about 0 V.

The position of the trigger level for the analog channel is indicated by the trigger level icon  (if the analog channel is on) at the left side of the display.

Trigger Coupling

Press the **Trigger Setup** button on the front panel to enter the TRIGGER function menu. Then, press the **Coupling** softkey and turn the **Universal Knob** or press the **Coupling** softkey continually to select the desired coupling mode.

The oscilloscope provides 4 kinds of trigger coupling modes:

- **DC:** allow DC and AC components into the trigger path.
- **AC:** block all the DC components and attenuate signals lower than 8 Hz. Use AC coupling to get a stable edge trigger when your waveform has a large DC offset.
- **LF Reject:** block the DC components and reject the low frequency components lower than 2 MHz. Low frequency reject removes unwanted low frequency components from a trigger waveform, such as power line frequencies, etc. that can interfere with proper triggering. Use **LF Reject** coupling to get a stable edge trigger when your waveform has low frequency noise.
- **HF Reject:** reject the high frequency components higher 1.2 MHz)

Note: trigger coupling has nothing to do with the channel coupling.

Trigger Holdoff

Trigger holdoff can be used to stably trigger the complex waveforms (such as pulse series). Holdoff time is the amount of time that the oscilloscope waits before re-arming the trigger circuitry. The oscilloscope will not trigger until the holdoff time expires.

Use the holdoff to trigger repetitive waveforms with multiple edges (or other events) between waveform repetitions. You can also use holdoff to trigger on the first edge of a burst when you know the minimum time between bursts.

For example, to get a stable trigger on the repetitive pulse burst below, set the holdoff time to be >200 ns but <600 ns.

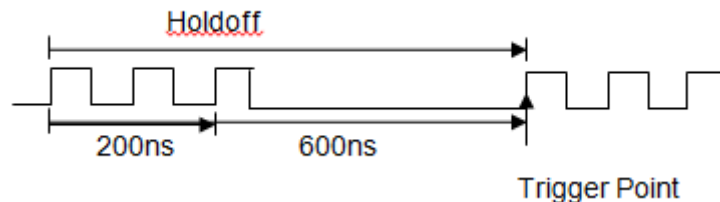

The correct holdoff setting is typically slightly less than one repetition of the waveform. Set the holdoff to this time to generate a unique trigger point for a repetitive waveform. Only edge trigger and serial trigger have holdoff option. The holdoff time of the oscilloscope is adjustable from 80ns to 1.5s.

1. Press the **Stop** button, and then use the **Horizontal Position** button and the **Horizontal Scale** button to find where the waveform repeats. Measure this time using cursors; then, set the holdoff.
2. Press the **Trigger Setup** button to enter the TRIGGER function menu. The default trigger type is edge.
3. Press the **Holdoff Close** softkey; and then turn the **Universal Knob** to set the desired holdoff time.

Note: adjust the time scale and horizontal position will not affect the holdoff

Noise Rejection

Noise Reject adds additional hysteresis to the trigger circuitry. By increasing the trigger hysteresis band, you reduce the possibility of triggering on noise. However, this also decreases the trigger sensitivity so that a slightly larger signal is required to trigger the oscilloscope.

Press the **Trigger Setup** button on the front panel, and then press the **Noise Reject** softkey continually to set the option to **On** or **Off** to turn on or off the noise rejection function.

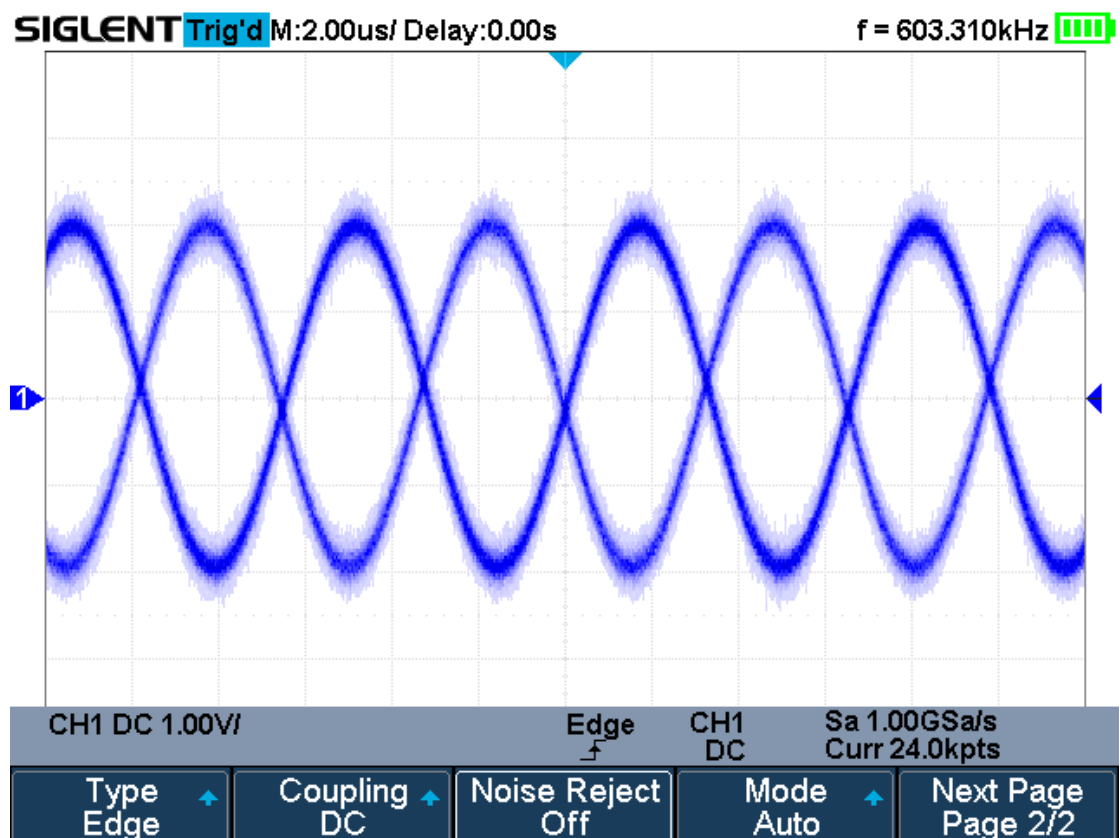

Figure 25 Turn off the Noise Reject

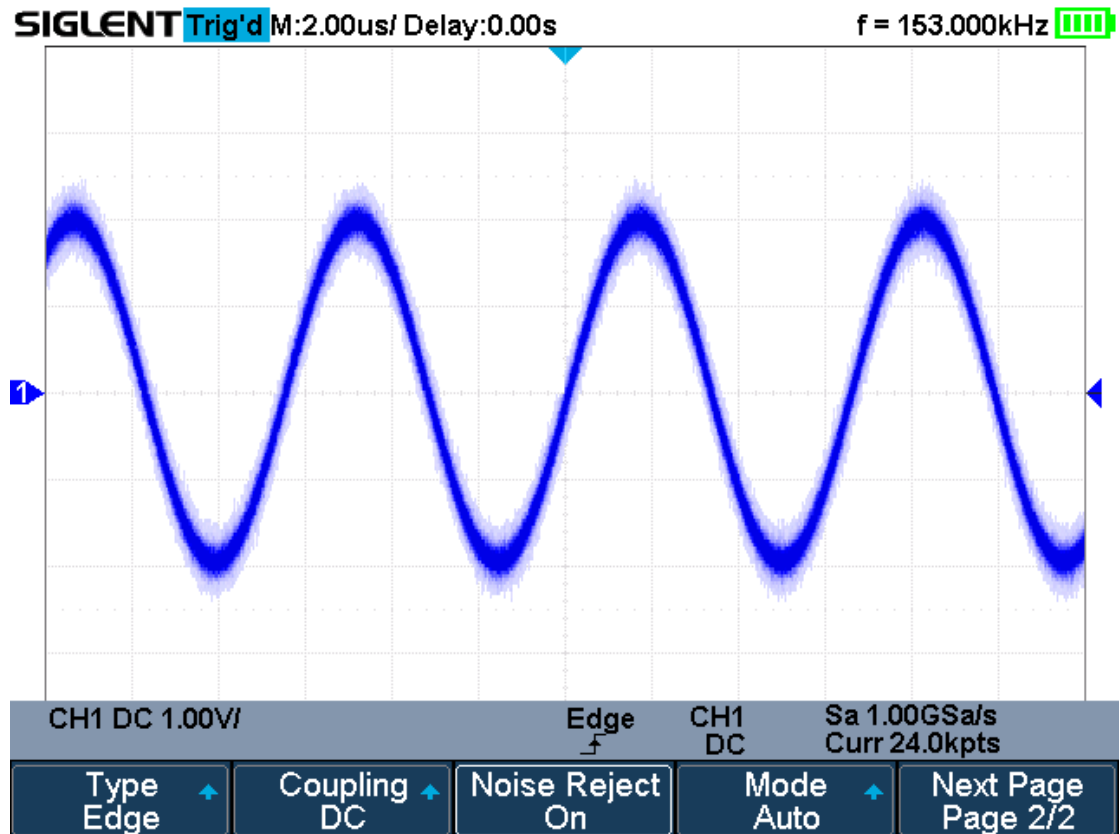

Figure 26 Turn on the Noise Reject

If the signal you are probing is noisy, you can set up the oscilloscope to reduce the noise in the trigger path and on the displayed waveform. First, stabilize the displayed waveform by removing the noise from the trigger path. Second, reduce the noise on the displayed waveform.

1. Connect a signal to the oscilloscope and obtain a stable display.
2. Remove the noise from the trigger path by setting trigger coupling to **LF Reject**, **HF Reject** or turning on **Noise Reject**.
3. Set the **Acquisition** option to **Average** to reduce noise on the displayed waveform.

Trigger Type

The oscilloscope provides abundant advanced trigger functions, including various serial bus triggers.

- ◆ Edge trigger
- ◆ Slope trigger
- ◆ Pulse trigger
- ◆ Video trigger
- ◆ Window trigger
- ◆ Interval trigger
- ◆ Dropout trigger
- ◆ Runt trigger
- ◆ Pattern trigger

Edge Trigger

Edge trigger distinguishes the trigger points by seeking the specified edge (rising, falling, alternating) and trigger level.

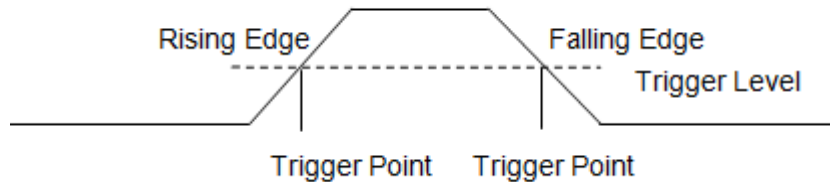

1. Press the **Trigger Setup** button on the front panel to enter the TRIGGER system function menu.
2. Press the **Type** softkey; turn the **Universal Knob** to set select **Edge** and then push the knob to confirm.
3. Press the **Source** softkey; turn the **Universal Knob** to select the deserted trigger source.
4. Press the **Slope** softkey; turn the **Universal Knob** to select the desired trigger edge (rising, falling or alternating), and then press down the knob to confirm. The current trigger slope is displayed at the bottom of the screen.
5. Press the **Trigger Level** button and turn the **Universal Knob** to adjust the trigger level to obtain stable trigger.

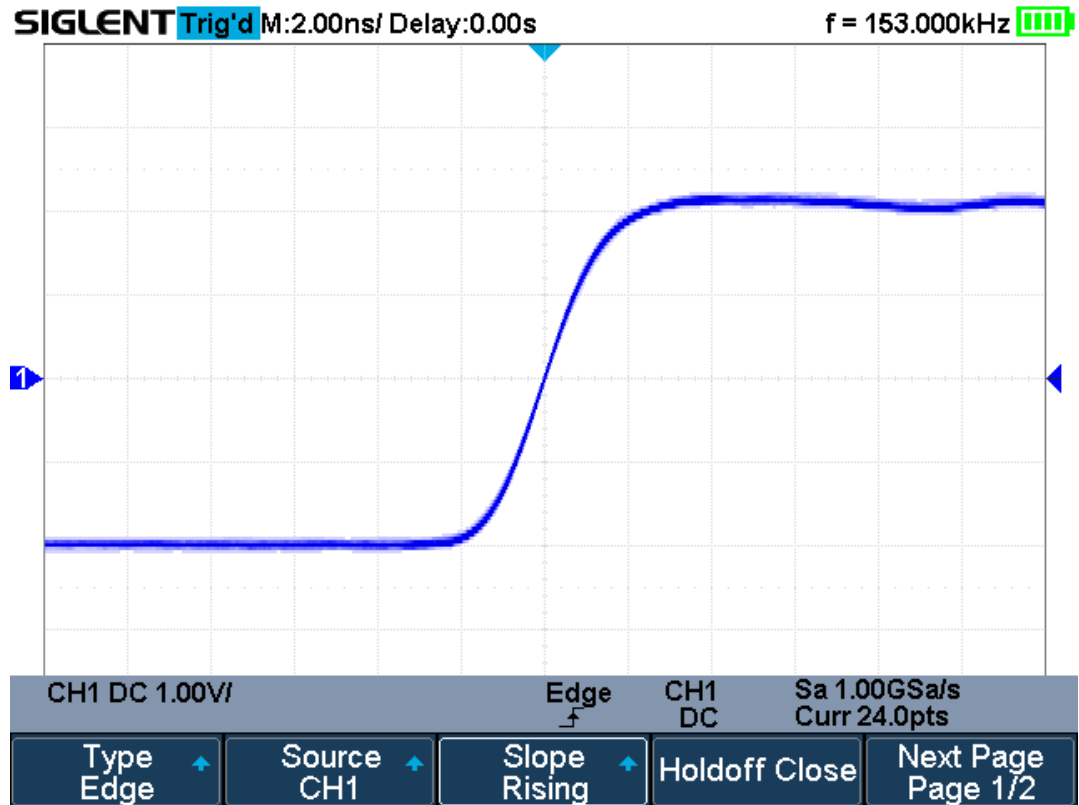

Figure 27 Edge Trigger

Holdoff, coupling and noise reject can be set in edge trigger, see the sections "Trigger Holdoff" , "Trigger Coupling" and "Noise Rejection" for details.

Note: Press the **Auto Setup** button will set the trigger type to Edge and slope to rising.

Slope Trigger

The slope trigger looks for a rising or falling transition from one level to another level in greater than or less than a certain amount of time.

In the oscilloscope, positive slope time is defined as the time difference between the two crossing points of trigger level line A and B with the positive edge as shown in the figure below.

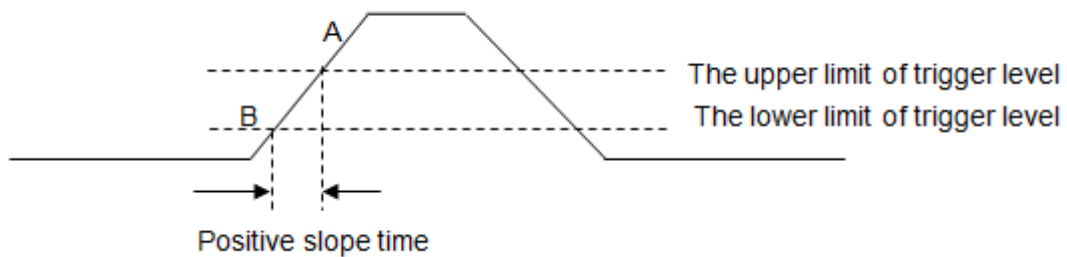

1. Press the **Trigger Setup** button on the front panel to enter the TRIGGER function menu.
2. Press the **Type** softkey; turn the **Universal Knob** to set select **Slope** and then push the knob to confirm.
3. Press the **Source** softkey; turn the **Universal Knob** to select the trigger source.
4. Press the **Slope** softkey; turn the **Universal Knob** to set select the desired trigger edge (rising or falling), and then push down the knob to confirm. The current trigger slope is displayed at the upper right corner of the screen.
5. Press **Lower Upper** softkey to select the **Lower** or **Upper** trigger level; then press the **Trigger Level** button and turn the **Universal Knob** to adjust the position.

The lower trigger level cannot be upper than the upper trigger level.

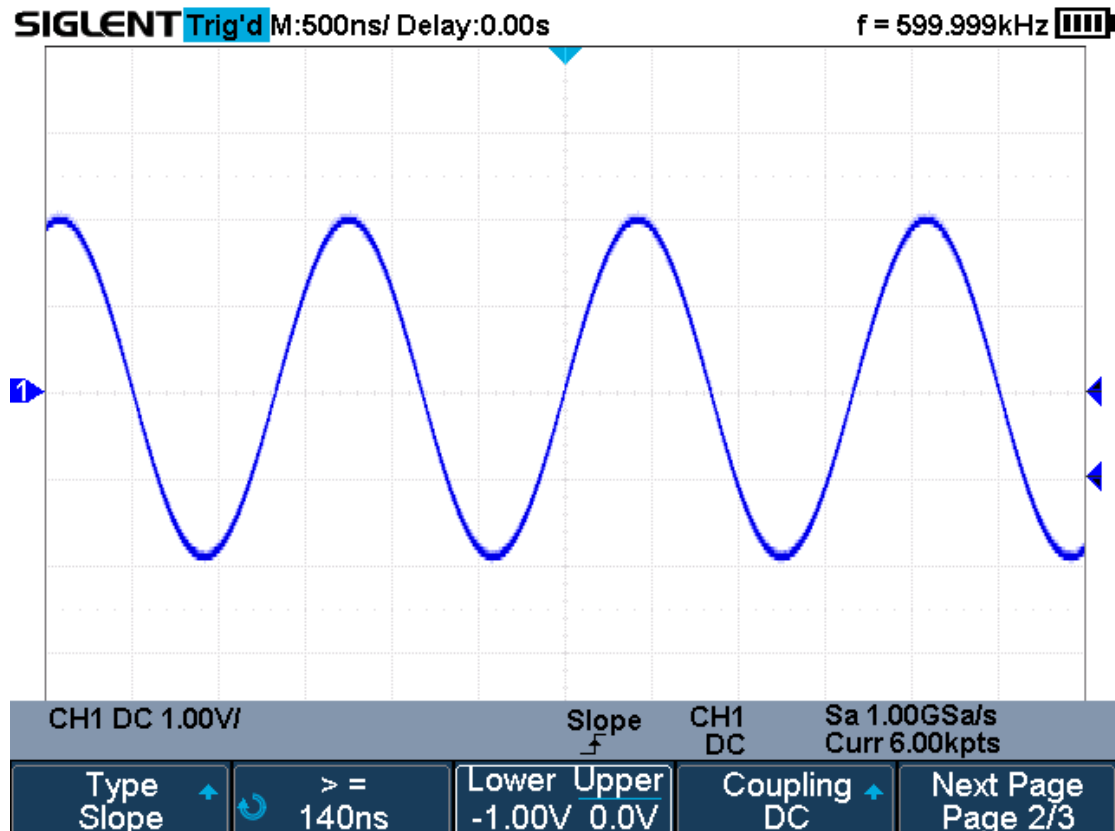

Figure 28 Slope Trigger

6. Press the **Limit Range** softkey; then turn the **Universal Knob** to select the desired slope condition, and push down the knob to confirm.
 - **\leq (less than a time value)**: trigger when the input signal's positive or negative slope time is lower than the specified time value.
 - **\geq (greater than a time value)**: trigger when the input signal's positive or negative slope time is greater than the specified time value.
 - **[--,--] (within a range of time value)**: trigger when the input signal's positive or negative slope time is greater than the specified lower limit of time and lower than the specified upper limit of time value.
 - **--][-- (outside a range of time value)**: trigger when the input signal's positive or negative slope time is greater than the specified upper limit of time and lower than the specified lower limit of time value.

Coupling and noise reject can be set in slope trigger, see the sections "**Trigger Coupling**" and "**Noise Rejection**" for details.

Pulse Trigger

Trigger on the positive or negative pulse with a specified width.

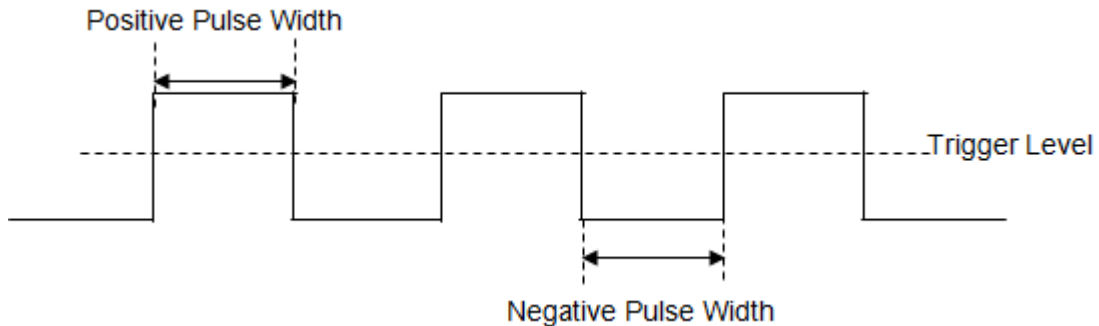

1. Press the **Trigger Setup** button on the front panel to enter the TRIGGER function menu.
2. Press the **Type** softkey; turn the **Universal Knob** to select **Pulse** and then push the knob to confirm.
3. Press the **Source** softkey; turn the **Universal Knob** to select CH1 or CH2 as the trigger source.
4. Press the **Trigger Level** button and turn the **Universal Knob** to adjust the trigger level to the desired place.
5. Press the **Polarity** softkey to select **Positive** or **Negative** pulse that to trigger on. The current trigger polarity is displayed at the upper right corner of the screen.
6. Press the **Limit Range** softkey; turn the **Universal Knob** to select the desired condition.
 - **<= (less than a time value)**: trigger when the input signal's positive or negative pulse time is lower than the specified time value.
For example, for a positive pulse, if you set t (pulse real width) $\leq 100\text{ns}$, the waveform will trigger.



- **>= (greater than a time value)**: trigger when the input signal's positive or negative pulse time is greater than the specified time value.
For example, for a positive pulse, if you set t (pulse real width) $\geq 100\text{ns}$, the waveform will trigger.



- **[--,--] (within a range of time value):** trigger when the input signal's positive or negative pulse time is greater than the specified lower limit of time and lower than the specified upper limit of time value.
For example, for a positive pulse, if you set t (pulse real width) $\geq 100\text{ns}$ and $t \leq 300\text{ns}$, the waveform will trigger.

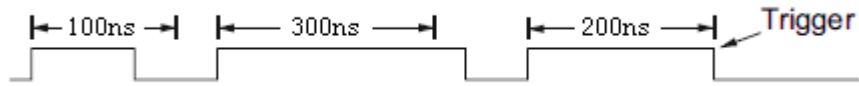

- **--][-- (outside a range of time value):** trigger when the input signal's positive or negative pulse time is greater than the specified upper limit of time and lower than the specified lower limit of time value.

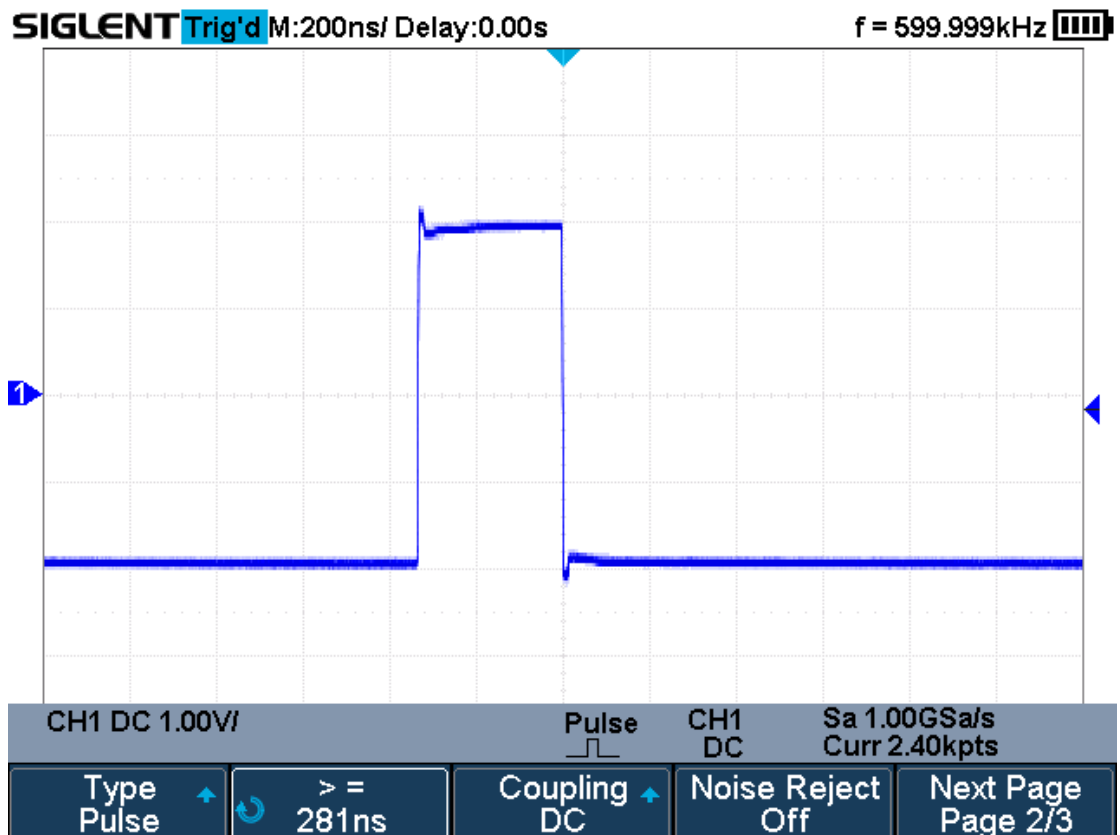

Figure 29 Pulse Trigger

Coupling and noise reject can be set in pulse trigger, see the sections "**Trigger Coupling**" and "**Noise Rejection**" for details.

Video Trigger

Video triggering can be used to capture the complicated waveforms of most standard analog video signals. The trigger circuitry detects the vertical and horizontal interval of the waveform and produces triggers based on the video trigger settings you have selected.

The oscilloscope supports standard video signal field or line of NTSC (National Television Standards Committee), PAL (Phase Alternating Line) HDTV (High Definition Television) and custom video signal trigger.

1. Press the **Trigger Setup** button on the front panel to enter the TRIGGER function menu.
2. Press the **Type** softkey; then turn the **Universal Knob** to select **Video** and push down the knob to confirm.
3. Press the **Source** softkey; turn the **Universal Knob** to select CH1 or CH2 as the trigger source. The trigger level is automatically set to the sync pulse.
4. Press the **Standard** softkey to select the desired video standard. The oscilloscope supports the following video standards.

Standard	Type	Sync Pulse
NTSC	Interlaced	BI-level
PAL	Interlaced	BI-level
HDTV 720P/50	Progressive	Tri-level
HDTV 720P/60	Progressive	Tri-level
HDTV 1080P/50	Progressive	Tri-level
HDTV 1080P/60	Progressive	Tri-level
HDTV 1080i/50	Progressive	Tri-level
HDTV 1080i/50	Progressive	Tri-level
Custom		

The table below shows the parameters of the Custom video trigger.

Frame Rate	25Hz, 30Hz, 50Hz, 60Hz	
Of Lines	300~2000	
Of Fields	1, 2, 3, 4	
Interlace	1:1, 2:1, 4:1, 8:1	
Trigger Position	Line	Field
	(line value)/1	1
	(line value)/2	2
	(line value)/3	3
	(line value)/4	4
	(line value)/5	5
	(line value)/6	6

	(line value)/7	7
	(line value)/8	8

The table below takes **Of Lines** as 800 as an example to explain the relation between **Of Lines**, **Of Fields**, **Interlace**, **Trigger Line** and **Trigger Field**.

Of Lines	Of Fields	Interlace	Trigger Line	Trigger Field
800	1	1:1	800	1
800	1,2,4 or 8	2:1	400	1, 1~2, 1~4, 1~8
800	1,2,4 or 8	4:1	200	1, 1~2, 1~4, 1~8
800	1,2,4 or 8	8:1	100	1, 1~2, 1~4, 1~8

- Press the **Sync** softkey to select **Any** or **Select** trigger mode.
 - Any**: trigger on any of the horizontal sync pulses
 - Select**: trigger on the appointed line and field you have set. Press the **Line** or **Field** softkey; then turn the **Universal Knob** to set the value.

The following table lists the line numbers per field for each video standard.

Standard	Field 1	Field 2
NTSC	1 to 262	1 to 263
PAL	1 to 312	1 to 313
HDTV 720P/50, HDTV 720P/60	1 to 750	
HDTV 1080P/50, HDTV 1080P/60	1 to 1125	
HDTV 1080iP/50, HDTV 1080i/60	1 to 562	1 to 563

The following are exercises to familiarize you with video triggering.

- To trigger on a specific line of video
- To use Custom video trigger

To Trigger on a Specific Line of Video

Video triggering requires greater than 1/2 division of sync amplitude with any analog channel as the trigger source.

The example below set to trigger on field 2, line 124 using the NTSC video standard.

- Press the **Trigger Setup** button on the front panel to enter the TRIGGER system function menu.
- Press the **Type** softkey; then use the **Universal Knob** to select Video and push down the knob to confirm.
- Press the **Source** softkey; turn the **Universal Knob** to select CH1 as the trigger source, and press the knob to confirm.
- Press the **Standard** softkey; turn the **Universal Knob** to select NTSC, and press the knob to confirm.
- Press the **Sync** softkey and set the option to **Select**; press the **Line** softkey and

then turn the universal to select **1** and push the knob to confirm; press the **Field** softkey and then turn the **Universal Knob** to select **1** and push the knob to confirm

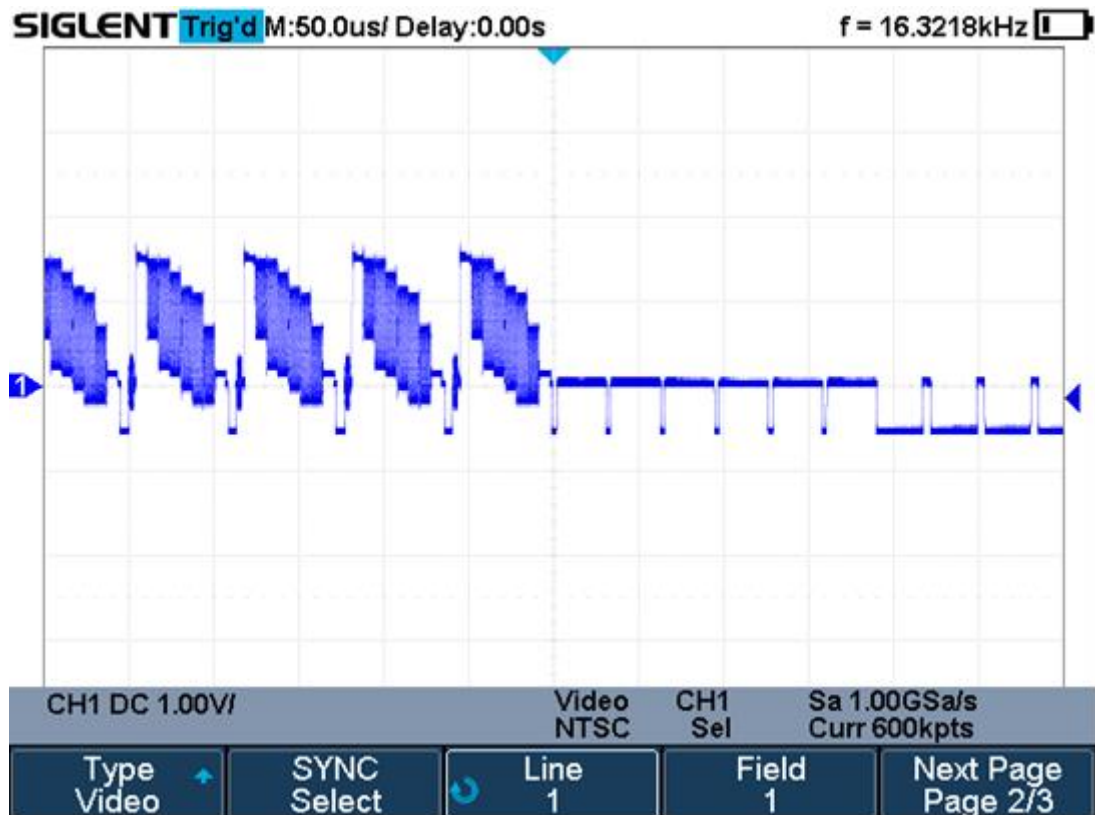

Figure 30 Video Trigger

To Use Custom Video Trigger

Custom video trigger supports frame rate of 25Hz, 30Hz, 50Hz and 60Hz, and the line range is available from 300 to 2000. The steps below show how to set custom trigger.

1. Press the **Trigger Setup** button on the front panel to enter the TRIGGER function menu.
2. Press the **Type** softkey; then use the **Universal Knob** to select **Video** and push down the knob to confirm.
3. Press the **Source** softkey; turn the **Universal Knob** to select **CH1** as the trigger source, and push down the knob to confirm.
4. Press the **Standard** softkey; turn the **Universal Knob** to select **Custom**, and push down the knob to confirm.
5. Press the **Setting** softkey to enter the custom setting function menu. Press the **Interlace** softkey; turn the **Universal Knob** to select the desired value.
6. Press the **Of Field** softkey; turn the **Universal Knob** to select the desired value.
7. Press the **Sync** softkey to enter the TRIG ON menu to set the line and field.
 - Press the **Type** softkey to select **Select** or **Any**.
 - If the **Type** option set to **Select**, press the **Line** softkey; turn the **Universal**

Knob to select the desired value. Press the **Field** softkey; turn the **Universal Knob** to select the desired value.

Window Trigger

Windows trigger provides a high trigger level and a low trigger level. The instrument triggers when the input signal passes through the high trigger level or the low trigger level.

There are two kinds of window types: Absolute and Relative. They have different trigger level adjustment methods. Under Absolute window type, the lower and the upper trigger levels can be adjusted respectively via the Level knob; under Relative window type, adjust the Center value to set the window center; adjust the Delta value to set the window range, the lower and the upper trigger levels always move together.

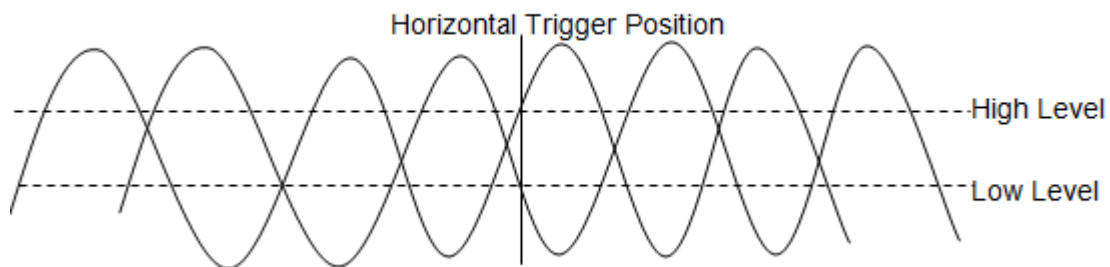

- If the lower and the upper trigger levels are both within the waveform amplitude range, the oscilloscope will trigger on both rising and falling edge.
- Suppose the upper trigger level is within the waveform amplitude range while the lower trigger level is out of the waveform amplitude range. In that case, the oscilloscope will trigger on rising edge only.
- Suppose the lower trigger level is within the waveform amplitude range while the upper trigger level is out of the waveform amplitude range. In that case, the oscilloscope will trigger on falling edge only.

To set window trigger via Absolute window type:

1. Press the **Trigger Setup** button on the front panel to enter the TRIGGER function menu.
2. Press the **Type** softkey; then use the **Universal Knob** to select **Window** and push down the knob to confirm.
3. Press the **Source** softkey; turn the **Universal Knob** to select CH1 or CH2 as the trigger source.
4. Press the **Window Type** softkey to select Absolute.
5. Press the **Lower Upper** softkey to select **Lower** or **Upper** trigger level; then press the **Trigger Level** button and turn the **Universal Knob** to adjust the

position. The trigger level values are displayed at the upper right corner of the screen.

The Lower trigger level cannot be upper than the upper trigger level.

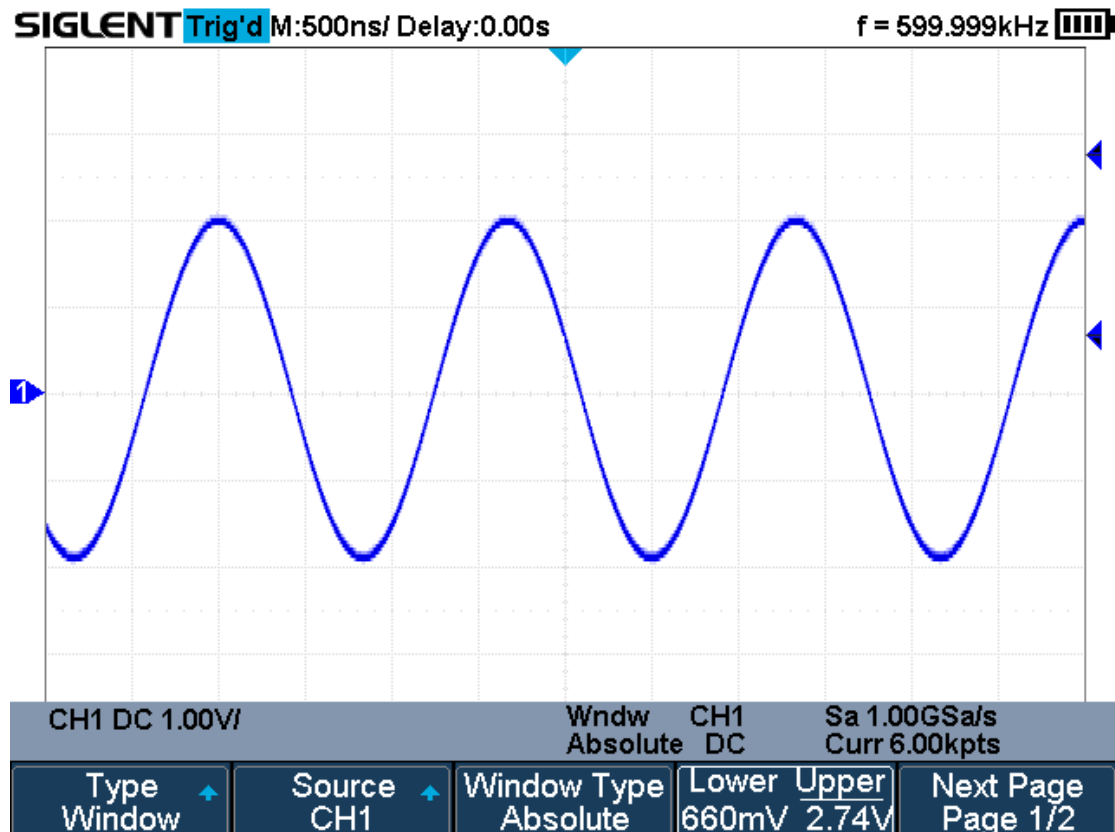

Figure 31 Absolute Window Trigger

To set window trigger via Relative window type:

1. Press the **Trigger Setup** button on the front panel to enter the TRIGGER system function menu.
2. Press the **Type** softkey; then use the **Universal Knob** to select **Window** and push down the knob to confirm.
3. Press the **Source** softkey; turn the **Universal Knob** to select CH1 or CH2 as the trigger source.
4. Press the **Window Type** softkey to select **Relative**.
5. Press the **Center Delta** softkey to select **Center** or **Delta** trigger level mode; then press the **Trigger Level** button and turn the **Universal Knob** to adjust the position.

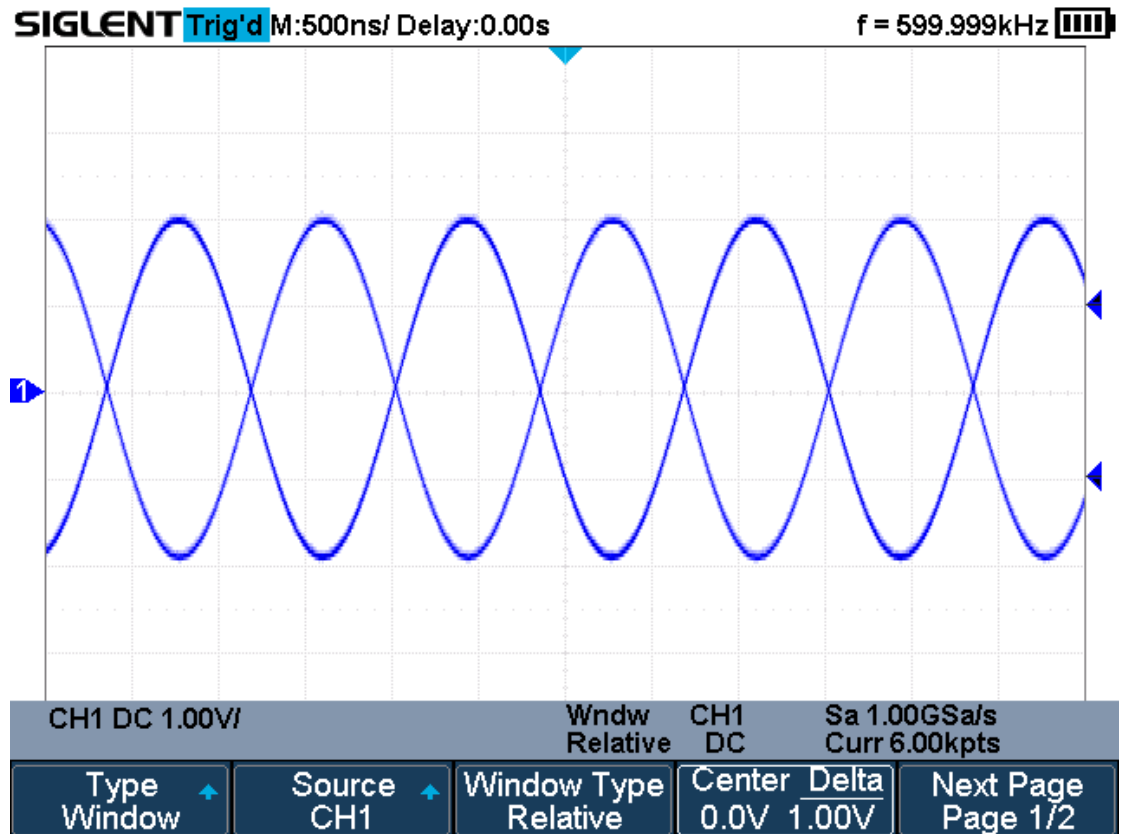
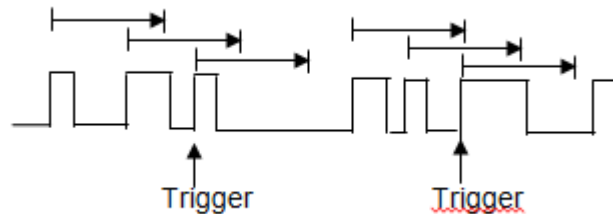

Figure 32 Relative Window Trigger

Coupling and noise reject can be set in Window trigger, see the sections "**Trigger Coupling**" and "**Noise Rejection**" for details.

Interval Trigger

Trigger when the times difference between the neighboring rising or falling edges meets the time limit (\leq , \geq , [--,--], --][--).



To set interval trigger:

1. Press the **Trigger Setup** button on the front panel to enter the TRIGGER system function menu.
2. Press the **Type** softkey; then use the **Universal Knob** to select **Interval** and push down the knob to confirm.
3. Press the **Source** softkey; turn the **Universal Knob** to select CH1 or CH2 as the trigger source.
4. Press the **Slope** softkey to select rising or falling edge.
5. Press the **Limit Range** softkey; turn the **Universal Knob** to select desired condition.
 - **\leq (less than a time value)**: trigger when the input signal's positive or negative pulse time is lower than the specified time value.
 - **\geq (greater than a time value)**: trigger when the input signal's positive or negative pulse time is greater than the specified time value.
 - **[--,--] (within a range of time value)**: trigger when the input signal's positive or negative pulse time is greater than the specified lower limit of time and lower than the specified upper limit of time value.
 - **--][-- (outside a range of time value)**: trigger when the input signal's positive or negative pulse time is greater than the specified upper limit of time and lower than the specified lower limit of time value.
6. Press the **Time Setting** softkey (\leq , \geq , [--,--], --][--), turn the **Universal Knob** to select the desired value.

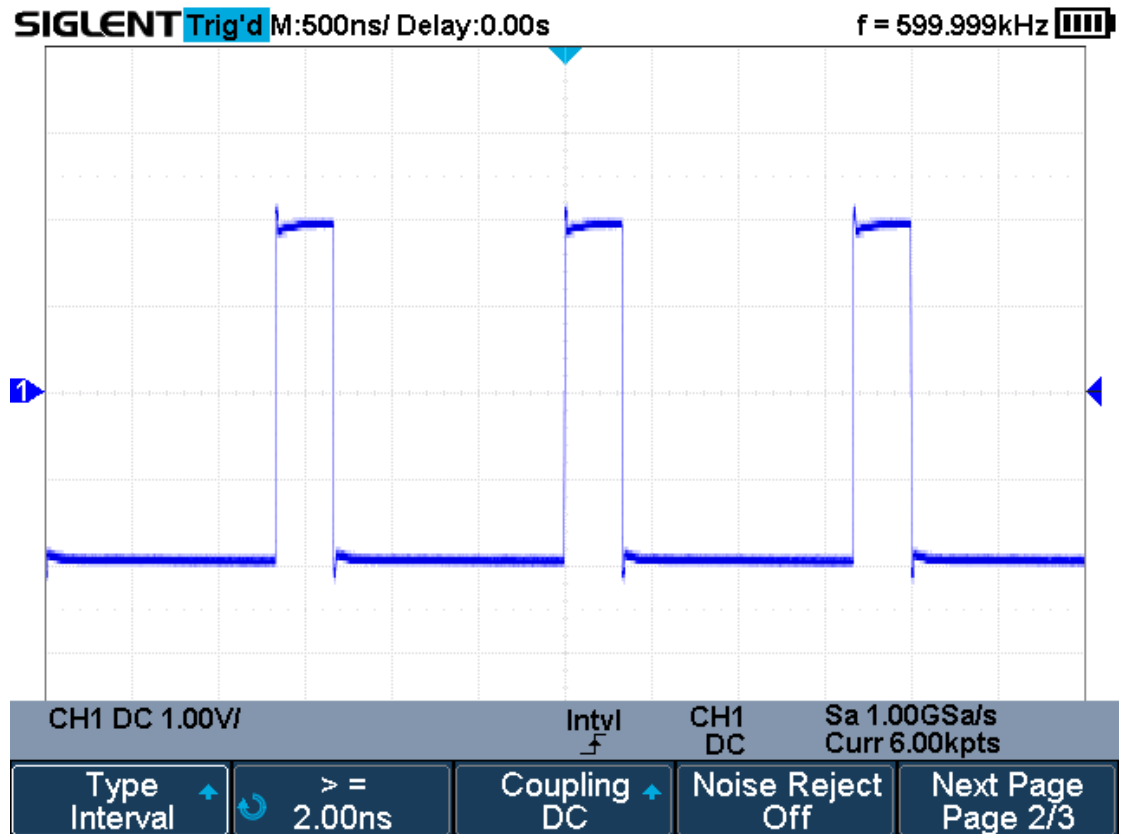

Figure 33 Interval Trigger

Coupling and noise reject can be set in interval trigger, see the sections "**Trigger Coupling**" and "**Noise Rejection**" for details.

Dropout Trigger

Dropout trigger includes two types: edge and state.

Edge

Trigger when the time interval (ΔT) from when the rising edge (or falling edge) of the input signal passes through the trigger level to when the neighboring rising edge (or falling edge) passes through the trigger level is greater than the timeout time set, as shown in the figure below.

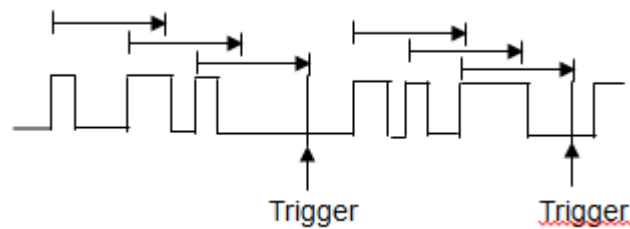

State

Trigger when the time interval (ΔT) from when the rising edge (or falling edge) of the input signal passes through the trigger level to when the neighboring falling edge (or rising edge) passes through the trigger level is greater than the timeout time set, as shown in the figure below.

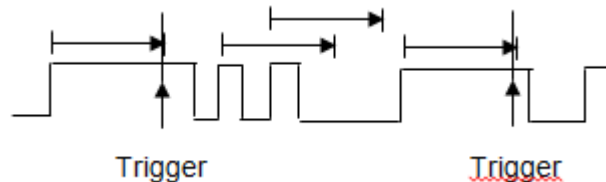

To set edge Dropout trigger:

1. Press the **Trigger Setup** button on the front panel to enter the TRIGGER system function menu.
2. Press the **Type** softkey; then use the **Universal Knob** to select **Dropout** and push down the knob to confirm.
3. Press the **Source** softkey; turn the **Universal Knob** to select CH1 or CH2 as the trigger source. The current trigger source is displayed at the upper right corner of the screen. Select channel with signal input as trigger source to obtain stable trigger.
4. Press the **Slope** softkey to select rising or falling edge.
5. Press the **OverTime Type** softkey to select **Edge**.
6. Press the **Time** softkey; turn the **Universal Knob** to select the desired value.

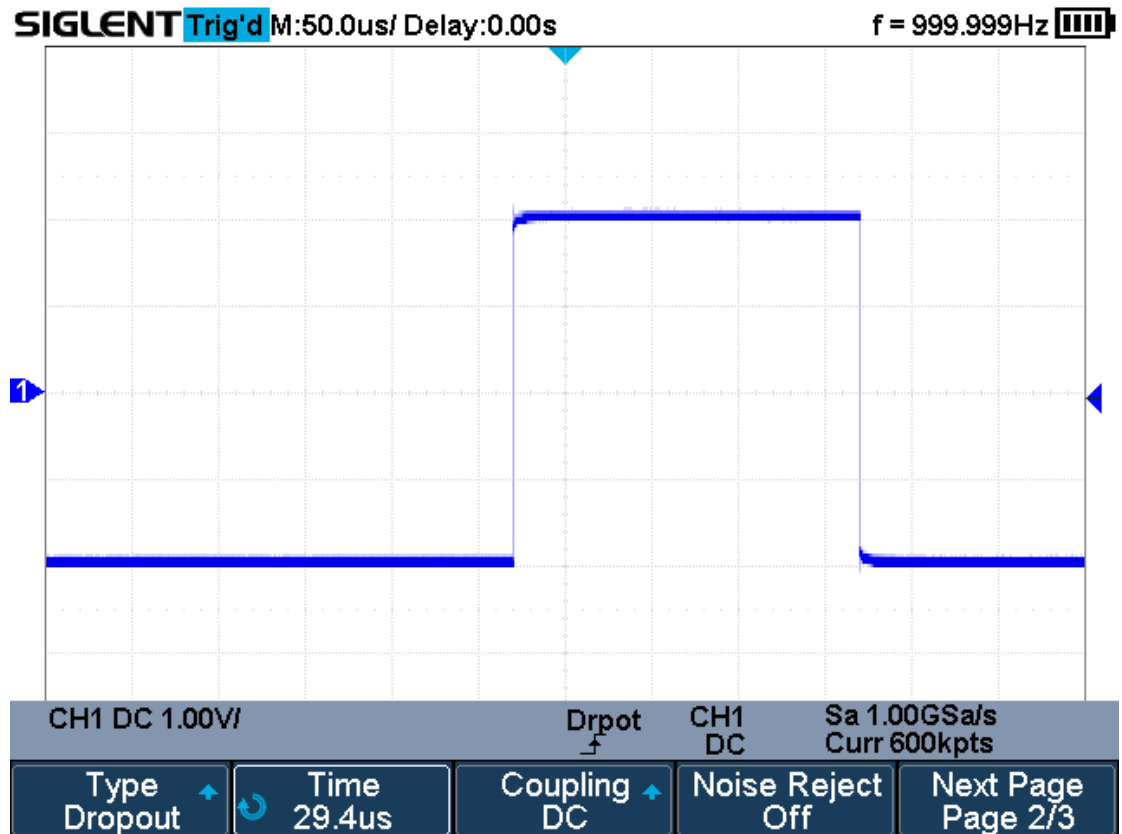

Figure 34 Edge Dropout Trigger

To set state Dropout trigger:

1. Press the **Trigger Setup** button to enter the TRIGGER system function menu.
2. Press the **Type** softkey; then turn the **Universal Knob** to select **Dropout** and push down the knob to confirm.
3. Press the **Source** softkey; turn the **Universal Knob** to select CH1 or CH2 as the trigger source.
4. Press the **Slope** softkey to select rising or falling edge.
5. Press the **OverTime** Type softkey to select State.
6. Press the **Time** softkey; turn the **Universal Knob** to select the desired value.

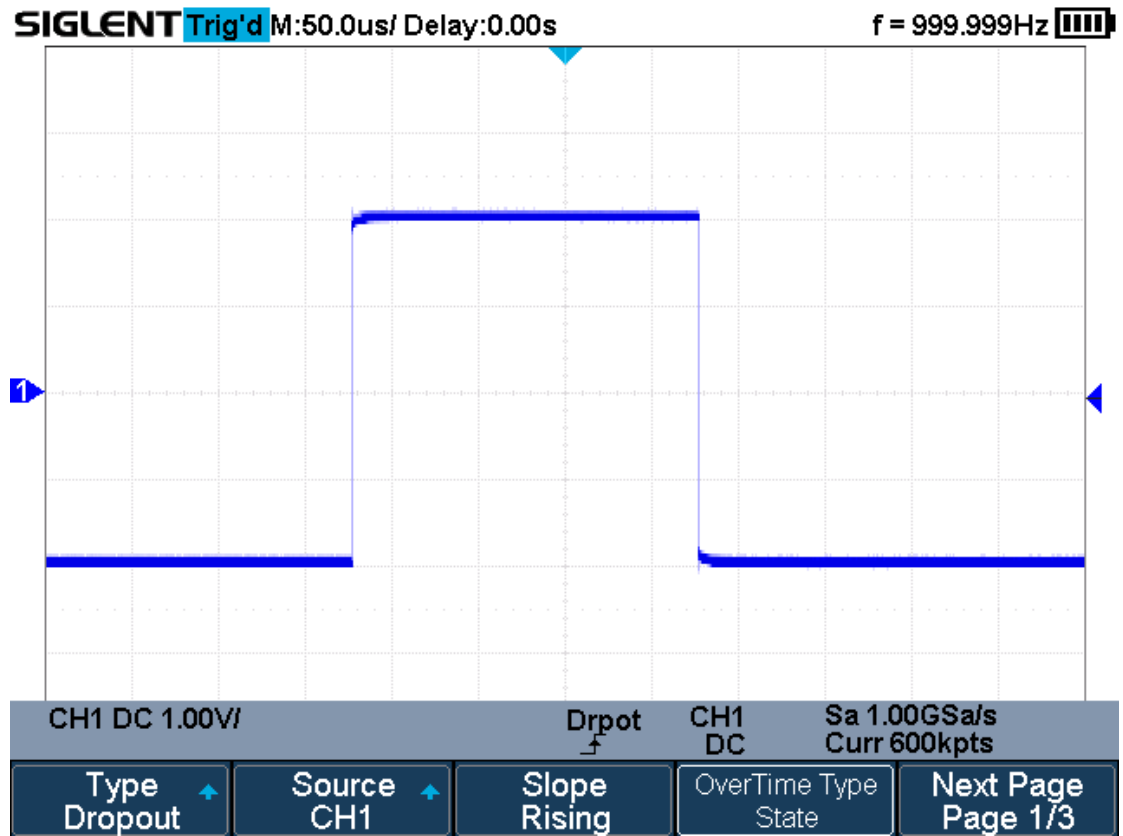
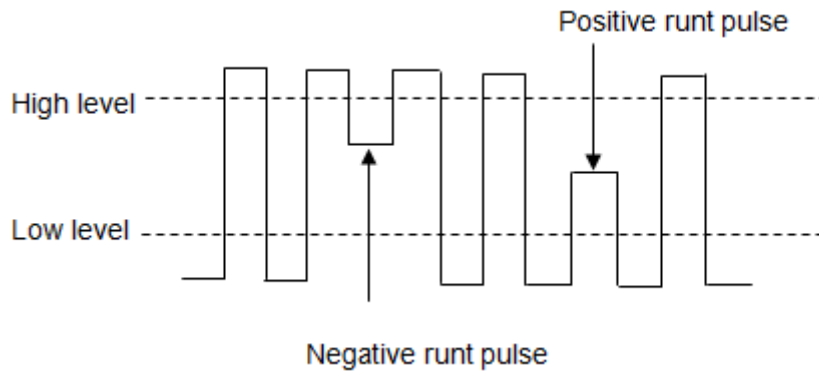

Figure 35 State Dropout Trigger

Coupling and noise reject can be set in dropout trigger, see the sections "Trigger Coupling" and "Noise Rejection" for details.

Runt Trigger

The Runt trigger looks for pulses that cross one threshold but not another as shown in the picture below.



- A positive runt pulse across through a lower threshold but not an upper threshold.
- A negative runt pulse across through an upper threshold but not a lower threshold.

To trigger on runt pulse:

1. Press the **Trigger Setup** button on the front panel to enter the **TRIGGER** system function menu.
2. Press the **Type** softkey; then turn the **Universal Knob** to select **Runt** and push down the knob to confirm.
3. Press the **Source** softkey; turn the **Universal Knob** to select CH1 or CH2 as the trigger source.
4. Press the **Polarity** softkey to select **Positive** or **Negative** pulse to trigger.
5. Press the **Limit Range** softkey; turn the **Universal Knob** to select the desired condition (\leq , \geq , $[-, -]$ or $--][--$).
6. Press the **Time Setting** softkey, and then turn the **Universal Knob** to select the desired value.
7. Press the **Next Page** softkey to enter the second page of the TRIGGER system function menu. Press the **Lower Upper** softkey to select **Lower** or **Upper** trigger level, and press the **Trigger Level** button and turn the **Universal Knob** to set the position.

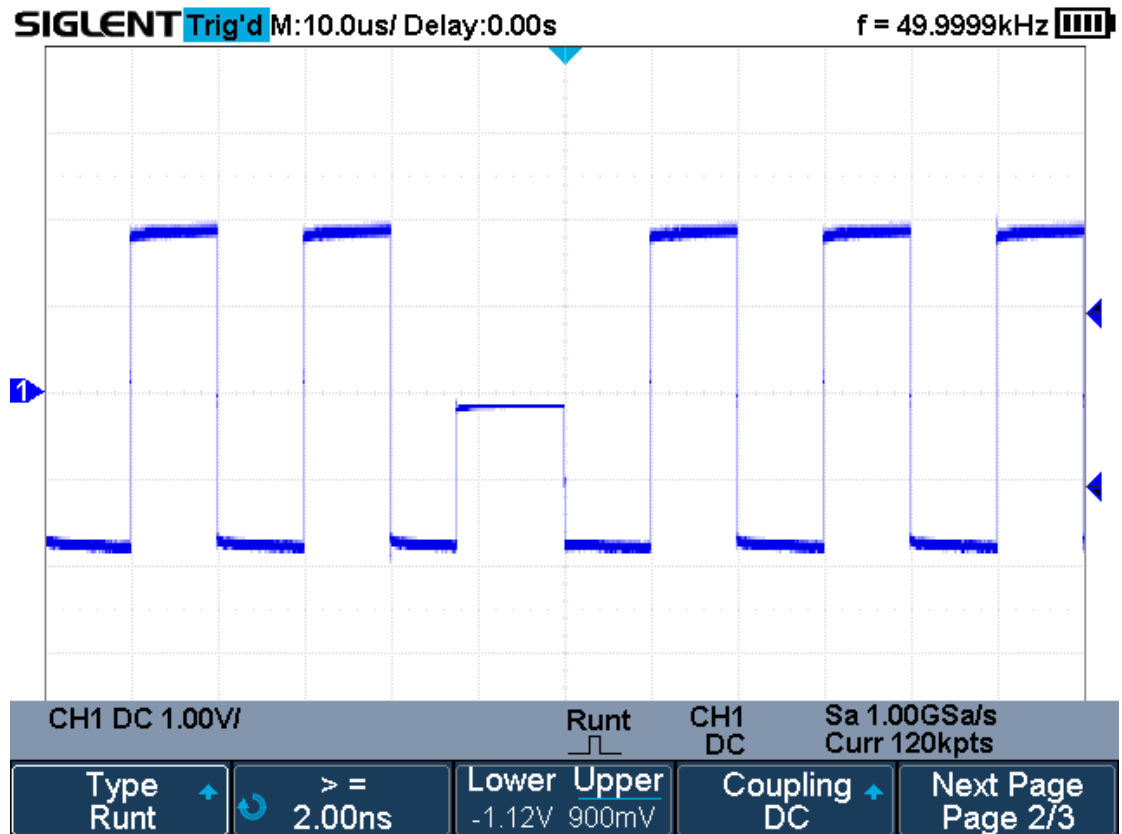
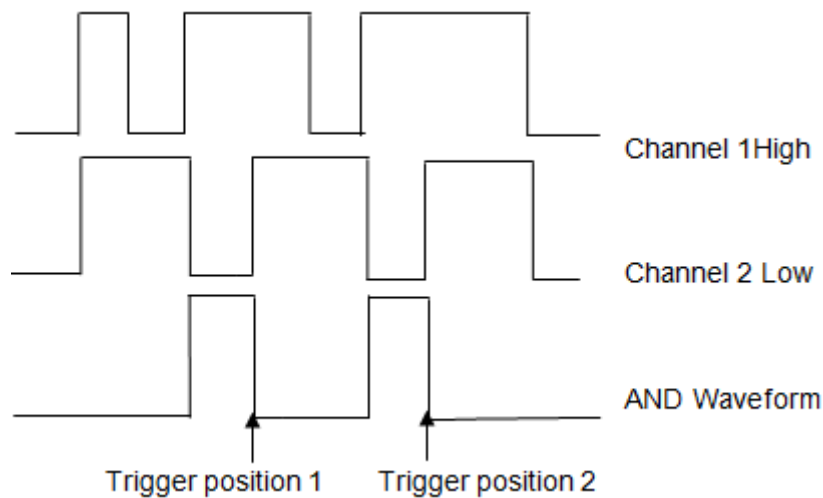

Figure 36 Runt Trigger

Coupling and noise reject can be set in runt trigger, see the sections "Trigger Coupling" and "Noise Rejection" for details.

Pattern Trigger

The Pattern trigger identifies a trigger condition by looking for a specified pattern. The pattern trigger can be expanded to incorporate delays similar to other triggers. Pattern durations are evaluated using a timer. The timer starts on the last edge that makes the pattern “true” . Potential triggers occur on the first edge that makes the pattern false, provided that the time qualifier criterion has been met. The oscilloscope provides 4 patterns: logical AND, OR, NAND and NOR combination of the channels. Each channel can set to low, high or invalid.



Do the following steps to set pattern trigger:

1. Press the **Trigger Setup** button on the front panel to enter the TRIGGER function menu.
2. Press the **Type** softkey; turn the **Universal Knob** to select **Pattern**, and then push down the knob to confirm.
3. Press the **Source** softkey to select channel, and then press the level type softkey to select **Don't care**, **High** or **Low**.
 - **Low** sets the pattern to low on the selected channel. A low is a voltage level that is less than the channel's trigger level or threshold level.
 - **High** sets the pattern to high on the selected channel. A high is a voltage level that is greater than the channel's trigger level or threshold level.
 - **Don't care** sets the pattern to don't care on the selected channel. Any channel set to don't care is ignored and is not used as part of the pattern.
 - However, if all channels in the pattern are set to **Don't care**, the oscilloscope will not trigger.

Adjust the trigger level for the selected analog channel by pressing the **Trigger Level** button and turning the **Universal Knob**. **Don't care** doesn't

need to set trigger level.

4. Press the **Next Page** softkey to enter the second page of the pattern trigger menu.
5. Press the **Logic** softkey and then turn the **Universal Knob** to select the desired logic combination **AND**, **OR**, **NAND** or **NOR**.
6. Press the **Time** softkey; then turn the **Universal Knob** to select the desired time value.
7. Press the **Holdoff Close** softkey to turn on the Holdoff function; then turn the **Universal Knob** to select the desired value.

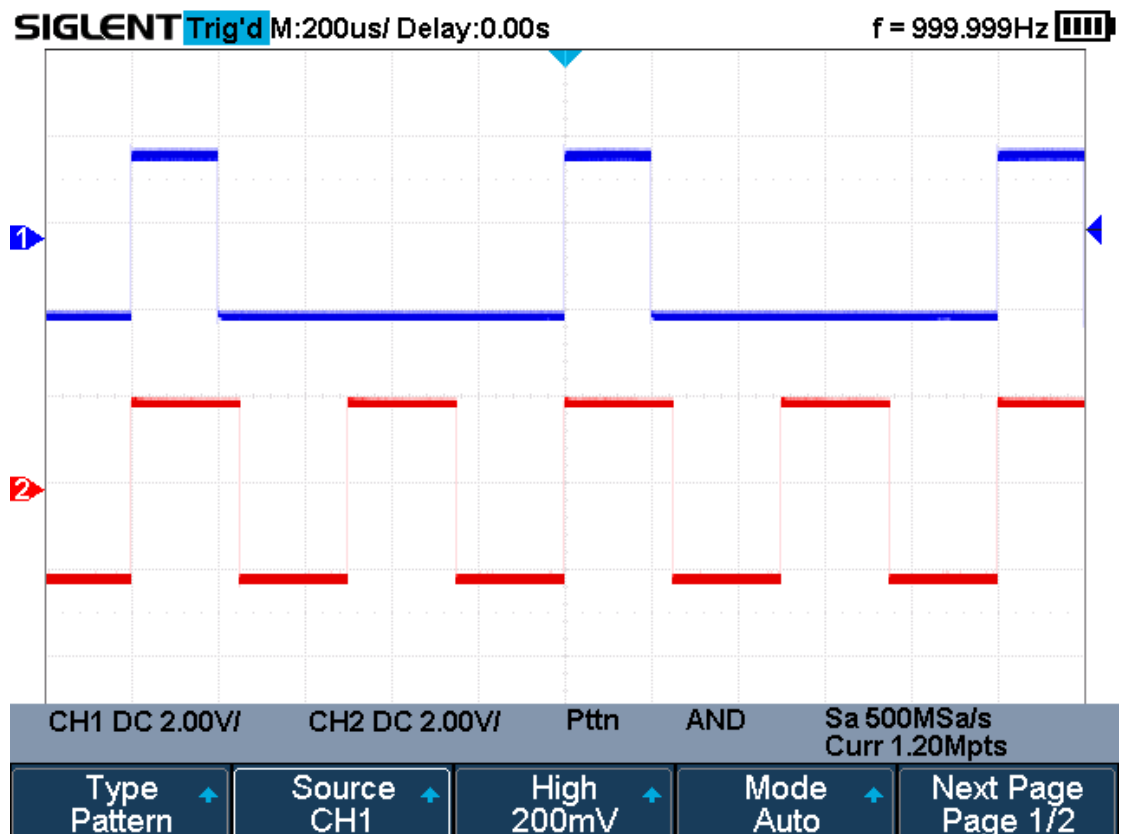

Figure 37 Pattern Trigger

Holdoff can be set in pattern trigger, see the sections "**Trigger Holdoff**" for details.

Serial Trigger and Decode

The oscilloscope provides I2C, SPI, UART, CAN and LIN serial trigger and decode. This chapter introduces the method of triggering and decoding these serial signals in details.

The contents of this chapter:

- ◆ I2C Trigger and Decode
- ◆ SPI Trigger and Decode
- ◆ UART Trigger and Decode
- ◆ CAN Trigger and Decode
- ◆ LIN Trigger and Decode

I2C Trigger and Serial Decode

Please in order of “Setup for I2C Signals” , “I2C Trigger” and “I2C Serial Decode” to trigger and decode the signals.

Setup for I2C Signals

Setting the I2C (Inter-IC bus) signal includes two steps: connecting the serial data signal (SDA) and serial clock signal (SCK) to oscilloscope, specifying the threshold voltage of each input signal.

1. Press the **Shift** and **Print** button to enter the **DECODE** function menu as Figure 38 shows.

Decode Decode 1	Protocol I2C	Signal	Configure	NextPage Page 1/3
Display Off	List	Format Hex	Copy Setting	NextPage Page 2/3
Tips Info On				NextPage Page 3/3

Figure 38 I2C DECODE Menu

2. Press the **Decode** softkey and select the desired slot (Decode1 or Decode2).
3. Press the **Protocol** softkey and then select **I2C** by turning **Universal Knob**.
4. Press the **Signal** softkey to enter the **SIGNAL** menu as Figure 39 shows.

SCL CH1	Threshold 0.00V	SDA CH2	Threshold 1.60V	←
------------	--------------------	------------	--------------------	---

Figure 39 I2C SIGNAL Menu

5. Set SCL (I2C's clock signal):
 - a. Press the **SCL** softkey to select the channel that is connected to the I2C clock signal.
 - b. Press the first **Threshold** softkey to set the I2C clock signal's threshold voltage level by **Universal Knob**. The threshold voltage level is for decoding, and it will be regard as the trigger voltage level when set the trigger type to serial.
6. Set SDA (I2C's data signal):
 - a. Press the **SDA** to select the channel that is connected to the I2C data signal.
 - b. Press the second **Threshold** softkey to set the I2C data signal's threshold voltage level by **Universal Knob**. The threshold voltage level is for decoding, and it will be regard as the trigger voltage level when set the trigger type to serial.

(Tips: SDA should keep stable during the whole high clock cycle, otherwise it

will be interpreted as a start or stop condition (data transitioning while the clock is high))

- Press the  softkey to return previous menu.

I2C Trigger

This part introduces the nine kinds of trigger conditions (Start, Stop, Restart, No Ack, EEPROM, 7 Addr&Data, 10 Addr&Data and Data Length) and the methods of setting them.

Trigger Conditions

- **Start Condition**— the oscilloscope will be triggered when SDA signal transitions from high to low while the SCL clock is high. If it is chosen as the trigger condition (including frame triggers), a restart will be treated as a “Start condition” .
- **Stop Condition**— the oscilloscope will be triggered when SDA transitions from low to high while the SCL is high.

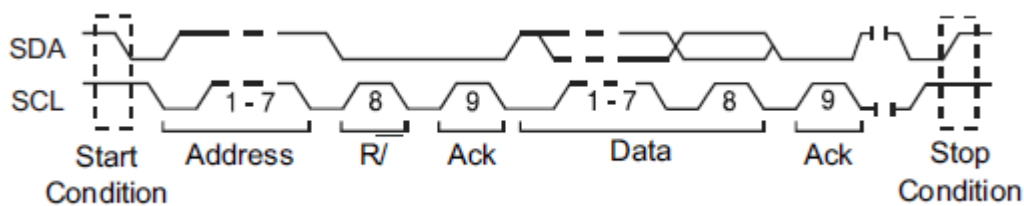

- **Restart**— the oscilloscope will be triggered when another “Start condition” occurs before a “Stop condition” .
- **No Ack**— the oscilloscope will be triggered when SDA data is high during any SCL’s ACK bit.
- **EEPROM** — the trigger searches for EEPROM control byte (the value is 1010xxx) on the SDA bus. And there is a Read bit and an ACK bit behind EEPROM. Using **Limit Range** softkey to set the qualifier and **Data1** softkey to set the data’s value. If EEPROM’s data is greater(less, equal) than Data1, the oscilloscope will be triggered at the edge of ACK bit behind Data byte. The Data byte mustn’t have to follow the EEPROM.

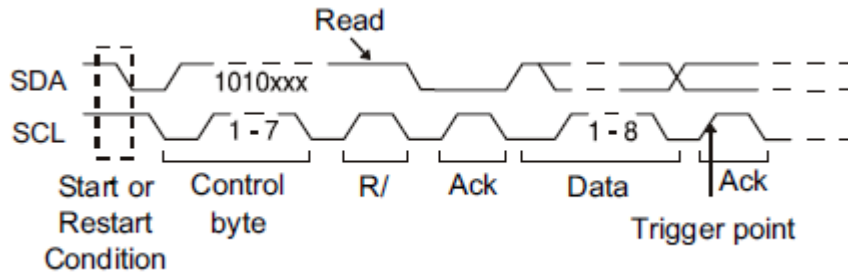

- **7 Address & Data** — the oscilloscope will be triggered when the following conditions are satisfied.
 - The address's length must be 7 bits and the address's value is the same as set value.
 - If you have set either Data1's or Data2's value, and the signal has a data is the same as that value. If you have set both Data1's and Data2's value, the signal should has two consecutive data, the first data's value is Data1, second data value is Data2.

(Note: If the data's value is 0xXX, any data value will be matched)

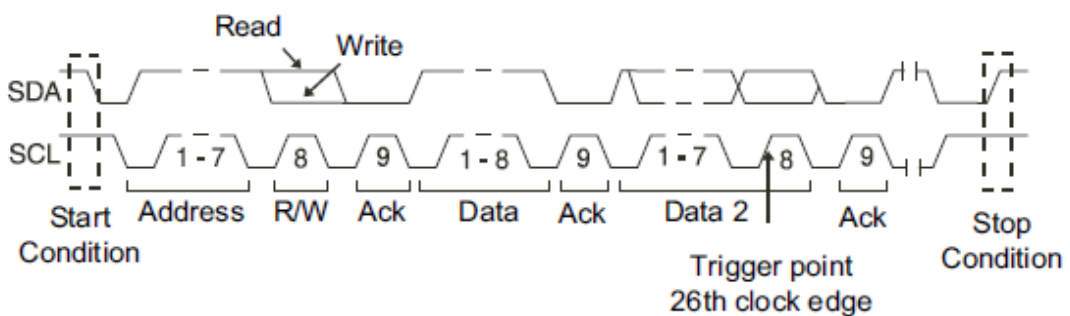
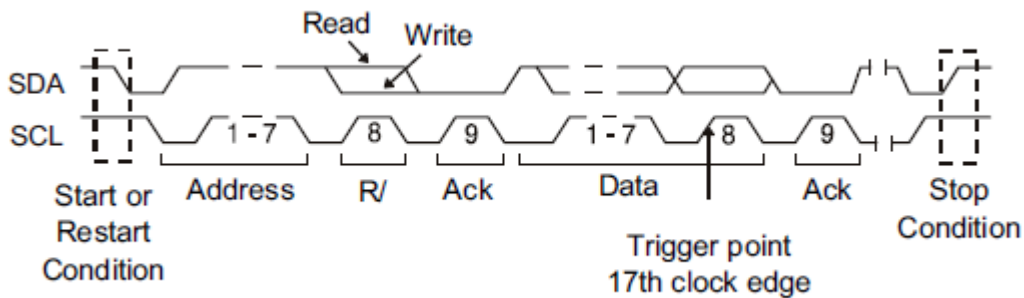

- **10 Address & Data** — the oscilloscope will be triggered when the following conditions are satisfied.
 - The address's length must be 10 bits and the address's value is the same as set value.
 - If you have set either Data1's or Data2's value, and the signal has a data

is the same as that value. If you have set both Data1's and Data2's value, the signal should have two consecutive data, the first data's value is Data1, second data value is Data2.

(Note: If the set value is 0xXX, any data value will be matched)

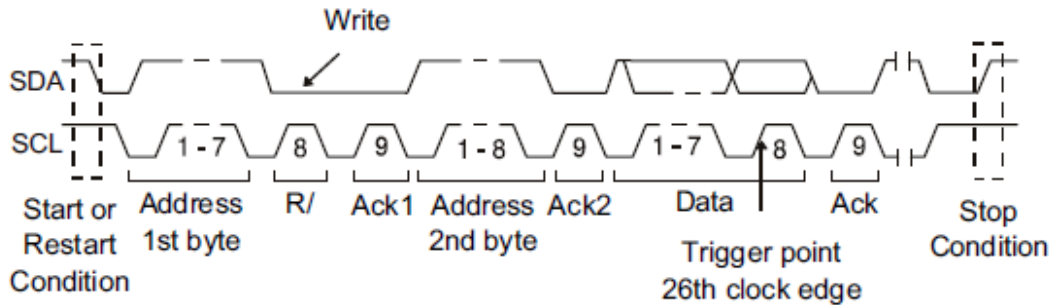

- **Data Length** — When SDA data's length is equal to the value of Byte Length and address's length is the same as set value, the oscilloscope will be triggered. Byte length is in the range of 1 to 12 bits.

Operation Steps

1. Press the **Trigger Setup** to enter the TRIGGER function menu.
2. Press the **Type** and select **Serial**.
3. Press the **Protocol** and select **I2C**.
4. Press the **Trigger Setting** softkey.

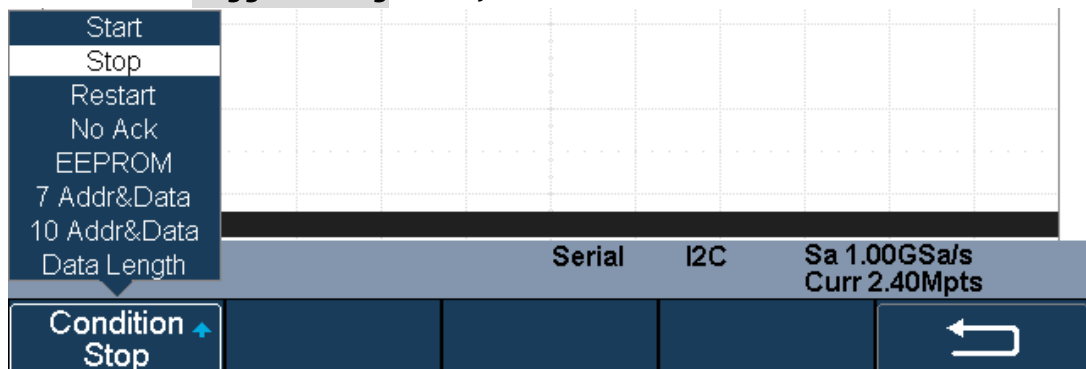

Figure 40 I2C TRIGGER Menu

5. Press the **Condition** softkey and turn the **Universal Knob** to select the trigger condition:
 - If you select the **EEPROM** condition:
 - a. Press the **Limit Range** softkey to set the qualifier (=, < or >).
 - b. Press the **Data1** softkey and set its value by turning the **Universal Knob**.
 - If you select **7 Addr & Data** or **10 Addr & Data** condition:

- a. Press the **Addr** softkey and turn the **Universal Knob** to select the 7-bit or 10-bit device address.
- b. Press the **Data1** or **Data2** softkey and set the value about them.
- c. Press the **R/W bit** softkey and select write-frame or read-frame to trigger the oscilloscope.

(**Tips:** If device address is 7-bit, the value of address is in range of 0x00 to 0x7F. If device's address is 10-bit, the value of address is in range of 0x00 to 0x3FF.)

- If you select the **Data Length** condition:
 - a. Press the **Address** to set the SDA address length 7bit or 10 bit.
 - b. Press the **Byte Length** softkey and set the byte length by **Universal Knob**. The range of the Byte Length is 1 to 12.

I2C Serial Decode

After completing the setup of I2C signal and trigger, we will decode I2C signals. Operation steps as follows.

1. Press **Shift** and **Print** → **Decode**. Select one of the options from the **Decode1** and **Decode2**.
2. Press the **Display** and select **On** to display the result of decoding.
3. Press the **Configure** to turn on or off the read or write bit.
4. Press the **List** to enter the **LIST** function menu.
 - Press the **Display** and choose the same options as the first step.
 - Press the **Scroll** and turn the **Universal Knob** to view all frames.
 - Press the **Lines** and set the number of lines by **Universal Knob**. The range of the lines is 1 to 7.
 - When a packet of data is long, all decoded data are not displayed. Turn on the **Long Data** to display the complete data.
 - Users can export the result list of the package to the external USB storage device in csv format (only when the USB flash disk is detected). Saving the data (*.csv) is similar to the operation of setup files, see the section "**External save and recall**" for details.
5. Press the **Format** to change the character encoding format of the decoding's result.
6. Press the **Copy Setting** to enter the **COPY** function menu to synchronize the corresponding bus configuration and trigger configuration.
7. Press the **Tips Info** to turn on or off the decoding limit prompt. When the decoding frame number reaches the maximum, it will pop up "Decoding to maximum frame number limitation!"

Interpreting I2C Decode

The frames of decoding result:

- The address value is displayed at the beginning of a frame. The write address is displayed in green, and read address in yellow.
- W/R bit is represented by (W) and (R), following the address value.
- The data value is displayed in white.
- "~A" after a data or address bits indicates no acknowledgement. For example, DB~A.
-  Indicates there is not enough space on the display to show the complete content of a frame, and some content is hidden.



Figure 41 I2C Decode Bus Display

The lists of decoding result:

- Time — the horizontal displacement between current frame and trigger position.
- Address — the address of a frame.
- R/W — the type of a frame (write or read).
- Data — the value of data.

I2C	Time	Address	R/W	Data(~A: no ack)
1	-2.52629ms	0x50	R	0xB0 C1~A
2	-2.11012ms	0x3C3	W	0xD2 E3
3	-1.52629ms	0x50	R	0xB0 C1~A
4	-1.11012ms	0x3C3	W	0xD2 E3
5	-526.288us	0x50	R	0xB0 C1~A
6	-110.118us	0x3C3	W	0xD2 E3
7	473.714us	0x50	R	0xB0 C1~A

Figure 42 I2C Decode List Display

SPI Trigger and Serial Decode

Please in order of “Setup for SPI Signals” , “SPI Trigger” and “SPI Serial Decode” to trigger and decode the signals.

Setup for SPI Signals

Setting the SPI (Serial Peripheral Interface) signal includes two steps: connecting the CLK, MISO, MOSI and CS signals to oscilloscope; specifying the parameters of each input signal.

1. Press the **Shift** and **Print** button to enter the **DECODE** function menu.
2. Press the **Decode** softkey and select the desired slot (Decode1 or Decode2).
3. Press the **Protocol** softkey and then select **SPI** by turning **Universal Knob**.
4. Press the **Signal** softkey to enter the **SIGNAL** menu as Figure 43 shows.



Figure 43 SPI SIGNAL Menu

5. Set CLK (clock signal):
 - a. Press the **CLK** softkey to enter **CLK** menu.
 - b. Press the **CLK** softkey to select the channel that is connected to the SPI clock signal.
 - c. Press the **Threshold** softkey to set the SPI clock signal's threshold voltage level by **Universal Knob**. The threshold voltage level is for decoding, and it will be regard as the trigger voltage level when set the trigger type to serial.
 - d. Press the **Edge Select** softkey to set the oscilloscope will samples at clock signal's rising edge or falling edge.
 - e. Press the **Return** softkey to return previous menu.



Figure 44 SPI CLK Menu

6. Set MISO:
 - a. Press the **MISO** softkey to enter the MISO menu.
 - b. Press the **MISO** softkey to select the channel that is connected to the SPI MISO signal.
 - c. Press the **Threshold** softkey to set the SPI MISO signal's threshold voltage level by **Universal Knob**. The threshold voltage level is for decoding, and it will be regard as the trigger voltage level when set the trigger type to serial.
 - d. Press the **Return** softkey to return previous menu.



Figure 45 MISO Menu



7. Set MOSI:
 - a. Press the **MOSI** softkey to enter the MOSI menu.
 - b. Press the **MOSI** softkey to select the channel that is connected to the SPI MOSI signal.
 - c. Press the **Threshold** softkey to set the SPI MOSI signal's threshold voltage level by **Universal Knob**. The threshold voltage level is for decoding, and it will be regard as the trigger voltage level when set the trigger type to serial.
 - d. Press the  softkey to return previous menu.



Figure 46 MOSI Menu

8. Set CS:
 - a. Press the **CS** softkey to enter the MOSI menu.
 - b. Press the **CS Type** softkey to select the chip select type.
 - c. Modify the Cs type's value.
 - d. Press the  softkey to return previous menu.

Function Menu	Settings	Explanation
CS Type	~CS	low voltage level of CS signal is available
	CS	high voltage level of CS signal is available
	CLK Timeout	<p>If the time between two edges of clock signal is less than (or equal to) the timeout value, the signal between the two edges is treated as a frame. The range of clock timeout is 100ns-5ms.</p> <p>This setting is suitable for case where CS signal is not connected, or the number of oscilloscope channels is insufficient.</p>

Table 1 Menu Explanations of the CS Type Parameters

Example:

Connect the data, CLK signals of a SPI bus respectively to C1, C2. Data width = 8-bit, Bit order = MSB, and 12 bytes are transmitted in one frame.

In the SPI trigger signal menu, set the source and threshold of CLK, MISO signals. Set the CS type to Clock Timeout, the clock idle time between frames is T3, the clock period is T1, then set the timeout to a value between T1 and T3:

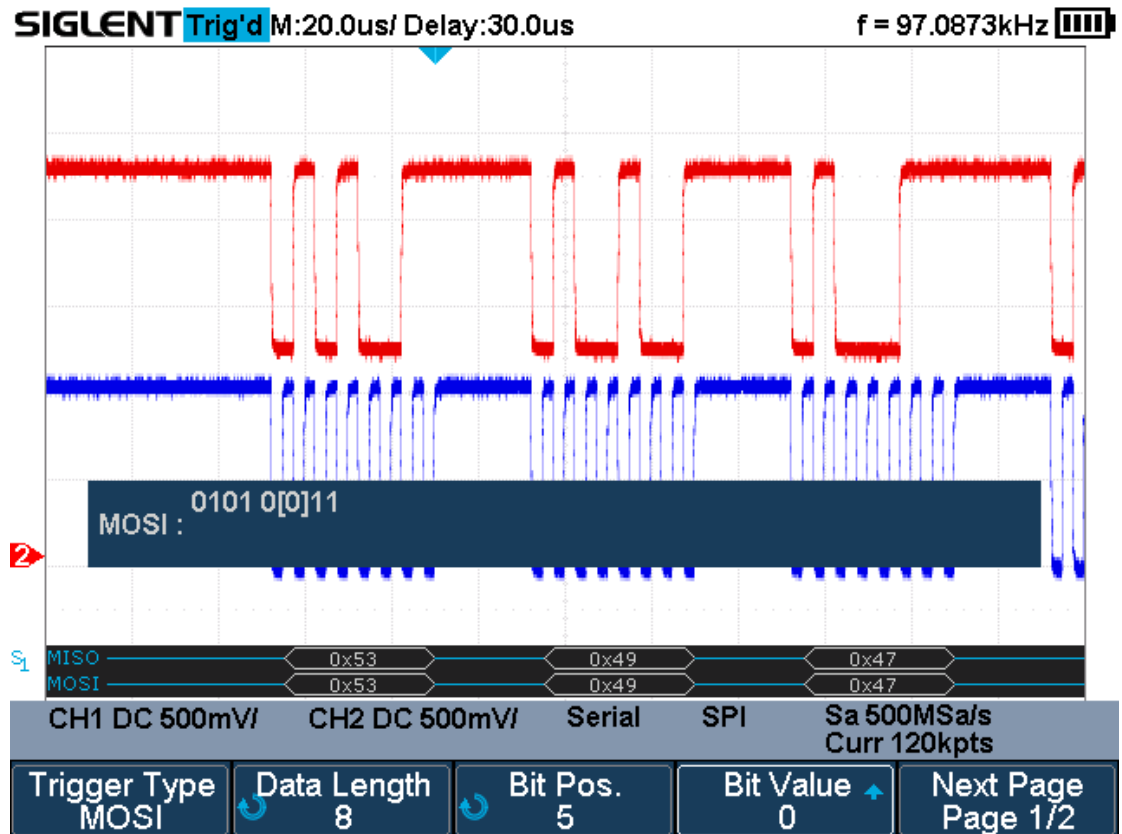

If the data width is set to be greater than 8 bits (such as 16 bits), the clock idle time between 8-bit data packets T2, and then set the timeout time to a value between T1/2+T2 and T3.

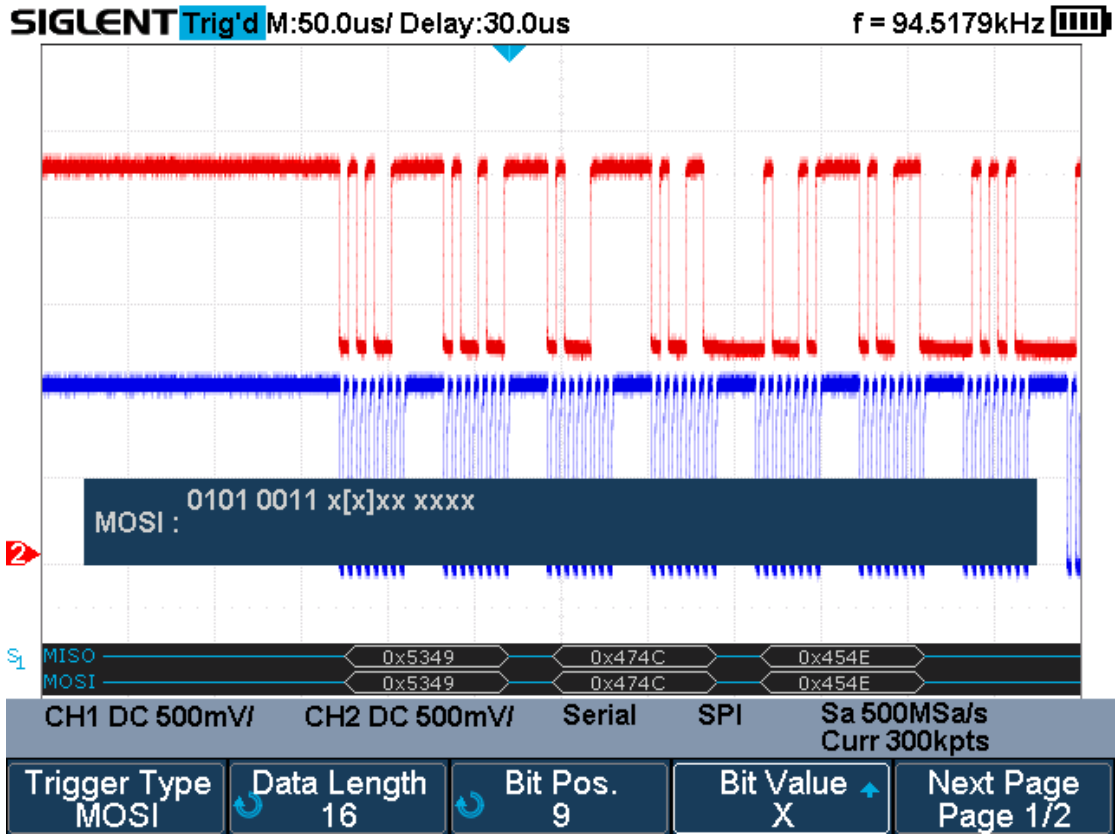

SPI Trigger

This part will provide a brief introduction and description for the operation of the SPI trigger.

1. Press the **Trigger Setup** button to enter the **TRIGGER** function menu.
2. Press the **Type** and select **Serial**.
3. Press the **Protocol** and select **SPI**.
4. Press the **Trigger Setting** softkey.

Trigger Type MISO	Data Length 4	Bit Pos. 0	Bit Value X	Next Page Page 1/2
All Same X	Bit Order LSB		←	Next Page Page 2/2

Figure 47 SPI TRIG SET Menu

5. Press the **Trigger Type** softkey to select the trigger condition.

Function Menu	Settings	Explanation
Trigger Type	MISO	Master-In, Slave-Out
	MOSI	Master-Out, Slave-In

Table 2 Menu Explanations of the SPI trigger type

6. Press the Data Length softkey, and turn the **Universal Knob** to set the length of a data. The range of data length is 4 to 96 bits.
7. Set the value of the trigger data.
 - Set the value of a bit:
 - a. Press the **Bit Roll** softkey to select a bit in data.
 - b. Press the **Bit Value** softkey to set the value of the selected bit.
 - Set the value of all bits:
 - a. Press the **All Same** softkey to set the value of all bits.

Function Menu	Settings	Explanation
Bit Value	0	High voltage level
	1	Low voltage level
	X	Don't care the voltage level

Table 3 Menu Explanations of the SPI Bit value

8. Press the **Next Page** softkey.
9. Press the **Bit Order** softkey to set the bit order (MSB or LSB).

SPI Serial Decode

After completing the setup of SPI signal and trigger, we will decode SPI signals. Operation steps as follows.

1. Press **Shift** and **Print** → **Decode**. Select one of the options from the **Decode1** and **Decode2**.
2. Press the **Configure** to set the bit stream format and bits (4-32 bits)
3. Press the **Display** and select **On** to display the result of decoding.
4. Press the **Configure** to set bit order and data length.
5. Press the **List** to enter the **LIST** function menu.
 - Press the **Display** and choose the same options as the first step.
 - Press the **Scroll** and turn the **Universal Knob** to view all frames.
 - Press the **Lines** and set the number of lines by **Universal Knob**. The range of the lines is 1 to 7.
 - Users can export the result list of the package to the external USB storage device in csv format (only when the USB flash disk is detected). Saving the data (*.csv) is similar to the operation of setup files, see the section "**External save and recall**" for details.
6. Press the **Format** to change the character encoding format of the decoding's result.
7. Press the **Copy Setting** to enter the **COPY** function menu to synchronize the corresponding bus configuration and trigger configuration.
8. Press the **Tips Info** to turn on or off the decoding limit prompt. When the decoding frame number reaches the maximum, it will pop up "Decoding to maximum frame number limitation!"

Interpreting SPI Decode

The frames of decoding result:

- The data values are displayed in frames and are shown in white. Support 4~96 bit data display.
- MISO — the decoding result of "Master-In, Slave-Out" line.
- MOSI —the decoding result of "Master-Out, Slave-In" line.
-  Indicates there is not enough space on the display to show the complete content of a frame, and some content is hidden.

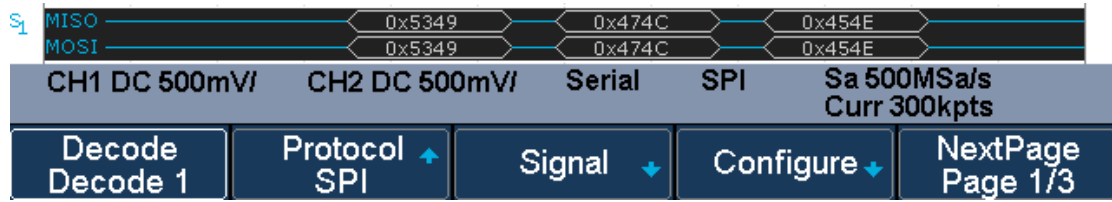

Figure 48 SPI Decode Bus Display

The lists of decoding result:

- Time — the horizontal displacement between current frame and trigger position.
- MISO — the decoding result of “Master-In, Slave-Out” line.
- MOSI —the decoding result of “Master-Out, Slave-In” line.

SPI	Time	MISO	MOSI
1	-35.0420us	0x5349	0x5349
2	84.9840us	0x474C	0x474C
3	204.950us	0x454E	0x454E
4	324.944us	0x545F	0x545F
5	444.910us	0x0000	0x0000
6	564.964us	0x0250	0x0250

Figure 49 SPI Decode List Display

UART Trigger and Serial Decode

Please in order of “Setup for UART Signals” , “UART Trigger” and “UART Serial Decode” to trigger and decode the signals.

Setup for UART Signals

1. Press the **Shift** and **Print** button to enter the **DECODE** function menu.
2. Press the **Decode** softkey and select the desired slot (Decode1 or Decode2).
3. Press the **Protocol** softkey and then select **UART** by turning **Universal Knob**.
4. Press the **Signal** softkey to enter the **SIGNAL** menu as below shows.



Figure 50 UART SIGNAL Menu

5. Set RX:
 - a. Press the **RX** to select the channel that is connected to the RX signal.
 - b. Press the first **Threshold** key to set the RX signal's threshold voltage level by **Universal Knob**. The threshold voltage level is for decoding, and it will be regard as the trigger voltage level when set the trigger type to serial.
6. Set TX:
 - a. Press the **TX** to select the channel that is connected to the TX signal.
 - b. Press the second **Threshold** key to set the TX signal's threshold voltage level by **Universal Knob**. The threshold voltage level is for decoding, and it will be regard as the trigger voltage level when set the trigger type to serial.
7. Press the **Return** softkey to return previous menu.
8. Press the **Configure** softkey to enter **BUS CONFIG** menu.



Figure 51 BUS CONFIG Menu

9. Press the **Baud** softkey to set baud rate.
 - The baud rate can be set as predefined value.
 - If the desired baud rate is not listed, press the **Baud** and select **custom** option, press the **Custom** and turn the **Universal Knob** to set the desired baud rate.
10. Press the **Data Length** softkey and set byte bits (5-8) by **Universal Knob**.
11. Press the **Parity Check** softkey to set the type of parity check (**Even, Odd, Mark, Space** or **None**).

12. Press the **Stop Bit** softkey to set the length of stop bit (**1, 1.5 or 2 bits**).
13. Press the **Next Page** softkey.
14. Press the **Bit Order** softkey to select the bit order (**LSB or MSB**).
15. Press the **Idle Level** softkey to set the idle level (**LOW or HIGH**).

UART Trigger

This part shows a brief introduction and description for the operation of the UART trigger.

1. Press the **Trigger Setup** button to enter the **TRIGGER** function menu.
2. Press the **Type** and select **Serial**.
3. Press the **Protocol** and select **UART**.
4. Press the **Trigger Setting** softkey to enter **UART TRIG SET** menu.



Figure 52 UART TRIG SET Menu

5. Press the **Source Type** softkey to select the source of trigger (RX or TX).
6. Press the **Condition** softkey and set up the desired trigger condition:
 - **Start** — the oscilloscope will be triggered at the position of start bit.
 - **Stop** — the oscilloscope will be triggered at the position of stop bits.
 - **Data** — the oscilloscope will be triggered when a byte is found equal to (greater or less than) the specified data.
 - a. Press the **Compare Type** softkey and choose an equality qualifier (>, < or =).
 - b. Press the **Value** softkey to set data's value. Data's value is in range of 0x00 to 0xff.
 - **ERROR** — if the parity check has been set, and the bit of parity check is error, the oscilloscope will be triggered.

UART Serial Decode

After completing the setup of UART signal and trigger, we will decode UART signals. Operation steps as follows.

1. Press **Shift** and **Print** → **Decode**. Select one of the options from the **Decode1** and **Decode2**.
2. Press the **Display** and select **On** to display the result of decoding.
3. Press the **Configure** to set the baud rate, data length, parity check, stop bit, idle level and bit order. Refer to “**Setup for UART Signals**” to set parameters.
4. Press the **List** to enter the **LIST** function menu.
 - Press the **Display** and choose the same options as the first step.
 - Press the **Scroll** and turn the **Universal Knob** to view all frames.
 - Press the **Lines** and set the number of lines by **Universal Knob**. The range of the lines is 1 to 7.
 - Users can export the result list of the package to the external USB storage device in csv format (only when the USB flash disk is detected). Saving the data (*.csv) is similar to the operation of setup files, see the section “**External save and recall**” for details.
5. Press the **Format** to change the character encoding format of the decoding’s result.
6. Press the **Copy Setting** to enter the **COPY** function menu to synchronize the corresponding bus configuration and trigger configuration.
7. Press the **Tips Info** to turn on or off the decoding limit prompt. When the decoding frame number reaches the maximum, it will pop up “Decoding to maximum frame number limitation!”

Interpreting UART Decode

The frames of decoding result:

- RX — the decoding result of the data received.
- TX — the decoding result of the data transmitted.
-  Indicates there is not enough space on the display to show the complete content of a frame, and some content is hidden.



Figure 53 UART Decode Bus Display

The lists of decoding result:

- Time— the horizontal displacement between current frame and trigger position.
- RX — the receiving channel.
- TX — the transmitting channel.
- RX Err— Parity error or unknown error in the data received.
- TX Err— Parity error or unknown error in the data transmitted.

UART	Time	RX	RX Err	TX	TX Err
1	-24.1920us	0x53			
2	-24.1920us			0x53	
3	65.4360us	0x49			
4	65.4360us			0x49	
5	154.975us	0x47			
6	154.975us			0x47	
7	244.575us	0x4C	Parity Err		

Figure 54 UART Decode List Display

CAN Trigger and Serial Decode

Please in order of “Setup for CAN Signals” , “CAN Trigger” and “CAN Serial Decode” to trigger and decode the signals.

Setup for CAN Signals

1. Press the **Shift** and **Print** button to enter the **DECODE** function menu.
2. Press the **Decode** softkey and select the desired slot (Decode1 or Decode2).
3. Press the **Protocol** softkey and then select **CAN** by turning **Universal Knob**.
4. Press the **Signal** softkey to enter the **SIGNAL** menu as below shows.



Figure 55 CAN SIGNAL Menu

- a. Press the **Source** softkey to select the channel that is connected to the CAN signal.
- b. Press the **Threshold** key to set the CAN signal's threshold voltage level by **Universal Knob**. The threshold voltage level is for decoding, and it will be regard as the trigger voltage level when set the trigger type to serial.
5. Press the **Configure** softkey to enter the **BUS CONFIG** menu.
6. Press the **Baud** to set baud rate by **Universal Knob**.
 - The baud rate can be set as predefined value (from 5kb/s to 1Mb/s) or custom value (from 5kb/s to 1Mb/s).
 - If the desired baud rate is not listed, press **Baud** and select **custom** option, press the **Custom** and turn the **Universal Knob** to set the desired baud rate.

CAN Trigger

This part will provide a brief introduction and description for the operation of the CAN trigger.

Trigger Conditions

- **Start**— the oscilloscope will be triggered at the start bit of a frame.
- **Remote** — the oscilloscope will be triggered by a remote frame with specified ID.
- **ID** — the oscilloscope will be triggered by a frame with specified ID.
- **ID+DATA**— the oscilloscope will be triggered by data frame that have specified ID and data.
- **Error** — the oscilloscope will be triggered by an error frame.

Operation Steps

1. Press the **Trigger Setup** to enter the **TRIGGER** function menu.
2. Press the **Type** and select **Serial**.
3. Press the **Protocol** and select **CAN**.
4. Press the **Trigger Setting** to enter the **CAN TRIG SET** menu.
5. Press the **Condition** and select the trigger condition by **Universal Knob**:
 - If you select the **REMOTE** and **ID** condition:
 - a. Press the **ID Bits** to set the length of ID (11bits or 29 bits).
 - b. Press the **Curr ID Byte** and use the **Universal Knob** to select the byte that you want to set.
 - c. Press the **ID** and set the ID's value by the **Universal Knob**.
(**Tips:** In order to make it convenient for the operation, ID is split into several bytes. For example, if the ID's length is 11 bits, it will be split into two bytes, a byte includes 8 bits. If "1st byte" is selected, only the 8 least significant bits can be changed.)
 - If you select the **ID+DATA** condition:
 - a. Press the **ID bits** softkey to select the ID's length (11 or 29 bits).
 - b. Press the **Curr ID Byte** softkey and use **Universal Knob** to select the byte that you want to modify.
 - c. Press the **ID** softkey and set the ID's value by **Universal Knob**.
 - d. Press the **Data** softkey and set the value of the first byte by **Universal Knob**.

CAN Serial Decode

After completing the setup of can signal and trigger, we will decode CAN signals. Operation steps as follows.

1. Press **Shift** and **Print** → **Decode**. Select one of the options from the **Decode1** and **Decode2**.
2. Press the **Display** and select **On** to display the result of decoding.
3. Press the **Configure** to set the baud rate.
4. Press the **List** to enter the **LIST** function menu.
 - Press the **Display** and choose the same options as the first step.
 - Press the **Scroll** and turn the **Universal Knob** to view all frames.
 - Press the **Lines** and set the number of lines by **Universal Knob**. The range of the lines is 1 to 7.
 - Users can export the result list of the package to the external USB storage device in csv format (only when the USB flash disk is detected). Saving the data (*.csv) is similar to the operation of setup files, see the section "**External save and recall**" for details.
5. Press the **Format** to change the character encoding format of the decoding's result.
6. Press the **Copy Setting** to enter the **COPY** function menu to synchronize the corresponding bus configuration and trigger configuration.
7. Press the **Tips Info** to turn on or off the decoding limit prompt. When the decoding frame number reaches the maximum, it will pop up "Decoding to maximum frame number limitation!"

Interpreting CAN Decode.

The frame of decoding result:

- Arbitration field is displayed in frame
- Control field is displayed in frame
- Data field is displayed in frame
- CRC field is displayed in frame
-  Indicates there is not enough space on the display to show complete content of a frame and some content is hidden.

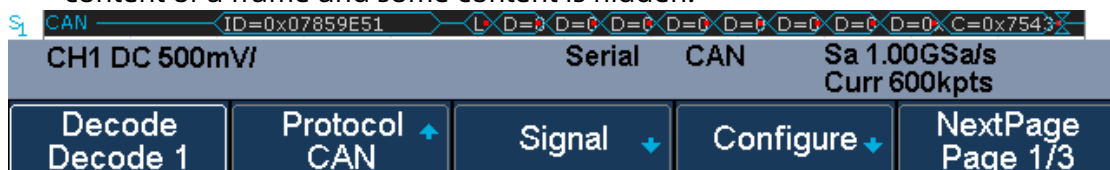

Figure 56 CAN Decode Bus Display

The list of decoding result:

- Time— the horizontal displacement between current frame and trigger position.
- Type — the type of frames, “D” represents data frame, “R” represents remote frame.
- ID — the id of frames, the oscilloscope can automatically detect the length of frame’s id (11 bits or 27 bits).
- Length — the length of data field.
- Data — the value of data field.
- CRC — the value of CRC (Cyclic Redundancy Check) field.
- ACK — Acknowledgment bit.

CAN	Time	Type	ID	Length	Data	CRC	ACK
1	-1.00906ms	Ext	0x07819F51	0x08	0x53 49 47 4C 45 4E 54 5F	0x7541	yes
2	-9.05500us	Ext	0x07819F51	0x08	0x53 49 47 4C 45 4E 54 5F	0x7541	yes
3	990.946us	Ext	0x07819F51	0x08	0x53		

Figure 57 CAN Decode List Displa

LIN Trigger and Serial Decode

Please take the order of “Setup for LIN Signals” , “LIN Trigger” and “LIN Serial Decode” to trigger and decode the signals.

Setup for LIN Signals

There are two steps of setting the LIN signal, connecting the signal to oscilloscope, and specifying each input signal's parameters.

1. Press the **Shift** and **Print** button to enter the DECODE function menu.
2. Press the **Decode** softkey and select the desired slot (Decode1 or Decode2).
3. Press the **Protocol** softkey and then select **LIN** by turning **Universal Knob**.
4. Press the **Signal** softkey to enter the **SIGNAL** menu as below shows.



Figure 58 LIN SIGNAL Menu

5. Press the **Source** softkey to select the channel that is connected to the LIN signal.
6. Press the **Threshold** softkey and set the LIN signal's threshold voltage level by **Universal Knob**. The threshold voltage level is for decoding, and it will be regard as the trigger voltage level when set the trigger type to serial.
7. Press the **Return** softkey to return previous menu.
8. Press the **Configure** softkey to enter the **BUS CONFIG** menu.
9. Press the **Baud** softkey to set baud rate.
 - The baud rate can be set as predefined value.
 - If the desired baud rate is not listed, select **Custom** option, press the **Custom** and turn the **Universal Knob** to set the desired baud rate.

LIN Trigger

This part will provide a brief introduction and description for the operation of the LIN trigger.

Trigger Conditions

- **Break** — the oscilloscope will be triggered at the position of break field's break delimiter.
- **ID (Frame ID)** — the oscilloscope will be triggered at the position of identifier field's stop bit, if the value of a frame's ID is equal to specified value.
(Note: If the data's value is 0xXX, any data value will be matched)
- **ID + Data (Frame ID and Data)** — the oscilloscope triggers when a frame with an ID and data equal to the selected values is detected. Use the **Universal Knob** to select the value for the ID, Data1 and Data2.
 - a. The ID's value is the same as set value.
 - b. If you have set either Data1's or Data2's value, and the signal has a data is the same as that value. If you have set both Data1's and Data2's value, the signal should has two consecutive data, the first data's value is Data1, second data value is Data2.
(Note: If the data's value is 0xXX, any data value will be matched)
- **Data Error** —the oscilloscope will be triggered when errors (ID check, checksum, and sync byte field errors) are detected.

Operation Steps

1. Press the **Trigger Setup** button to enter the **TRIGGER** function menu.
2. Press the **Type** and select **Serial**.
3. Press the **Protocol** and select **I2C**.
4. Press the **Trigger Setting** softkey to enter **LIN TRIG SET** menu.
5. Press the **Condition** and select the trigger condition by **Universal Knob**:
 - If you select **ID** condition:
 - a. Press the **ID** softkey and set its value by turning the **Universal Knob**.
 - If you select **ID+DATA** condition:
 - a. Press the **ID** softkey and set its value by turning the **Universal Knob**.
 - b. Press the **DATA1** softkey and set its value by turning the **Universal Knob**.
 - c. Press the **DATA2** softkey and set its value by turning the **Universal Knob**.

LIN Serial Decode

After completing the setup of LIN signal and trigger, we will decode LIN signals. Operation steps as follows.

1. Press **Shift** and **Print** → **Decode**. Select one of the options from the **Decode1** and **Decode2**.
2. Press the **Display** and select **On** to display the result of decoding.
3. Press the **Configure** to set the baud rate.
4. Press the **List** to enter the **LIST** function menu.
 - Press the **Display** and choose the same options as the first step.
 - Press the **Scroll** and turn the **Universal Knob** to view all frames.
 - Press the **Lines** and set the number of lines by **Universal Knob**. The range of the lines is 1 to 7.
 - Users can export the result list of the package to the external USB storage device in csv format (only when the USB flash disk is detected). Saving the data (*.csv) is similar to the operation of setup files, see the section "**External save and recall**" for details.
5. Press the **Format** to change the character encoding format of the decoding's result.
6. Press the **Copy Setting** to enter the **COPY** function menu to synchronize the corresponding bus configuration and trigger configuration.
7. Press the **Tips Info** to turn on or off the decoding limit prompt. When the decoding frame number reaches the maximum, it will pop up "Decoding to maximum frame number limitation!"

Interpreting LIN Decode

The frame of decoding result:

- Protected Identifier Field is displayed in frame
- Data Length is displayed in frame
- Data Field is displayed in frame.
- Checksum Field is displayed in frame.
-  Indicates there is not enough space on the display to show complete content of a frame and some content is hidden.

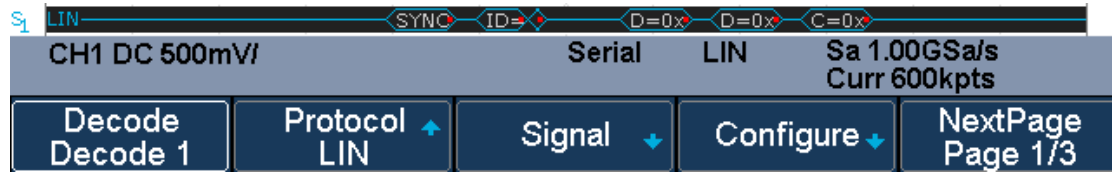

Figure 59 LIN Decode Bus Display

The list of decoding result:

- Time— the horizontal displacement between current frame and trigger position.
- ID — the value of frame’s Protected Identifier Field.
- Data Length — the length of Data Field.
- ID Parity — the two check bits of Protected Identifier Field.
- Data — the value of Data Field.
- Checksum— the value of Checksum Field.

LIN	Time	ID	Data Length	ID Parity	Data	Checksum
1	-2.07519ms	0x06	2	0	0x54 5F	0x46
2	-1.07519ms	0x06	2	0	0x54 5F	0x46
3	-75.1870us	0x06	2	0	0x54 5F	0x46
4	924.814us	0x06	2	0	0x54 5F	0x46
5	1.92481ms	0x06	2	0	0x54 5F	0x46

Figure 60 LIN Decode List Display

Reference Waveform

The oscilloscope can save the analog channel waveform or math waveform to the reference waveform position in the oscilloscope. Then, a reference waveform can be displayed and compared against other waveforms. All reference waveforms can be displayed at a time.

The contents of this chapter:

- ◆ Save REF Waveform to Internal Memory
- ◆ Display REF Waveform
- ◆ Adjust REF Waveform
- ◆ Clear REF Waveform

Save REF Waveform to Internal Memory

Do the following steps to save the REF waveform to internal memory:

1. Press the **Shift** and **Hide Menu** button on the front panel to enter the REF WAVE function menu. Note that when the time horizontal format is in X-Y mode, REF function cannot be enabled.
2. Press the **Source** softkey; then, turn the **Universal Knob** to select the source of reference channel. The source includes analog channel and math waveforms.
3. Press the **Location** softkey; then, turn the **Universal Knob** to select the position to save the REF waveform. The source includes analog channel and math waveforms.
4. Press the **Save** softkey to save the channel or math waveform to the appointed location. The vertical scale information and the vertical offset of the waveform will be saved at the same time. It will pop out the message "**Saved to internal file REF***" when the waveform has been saved successfully.

Note: The REF waveforms are non-volatile. The REF waveform can still be saved after restarts or default operation.

Display REF Waveform

To the following steps to display REF waveform:

1. Press the **Shift** and **Hide Menu** button on the front panel to enter the REF WAVE function menu.
2. Press the **Location** softkey; then, turn the **Universal Knob** to select the REF waveform that you want to display.
3. Press the **Display** softkey to select **On** to display the REF waveform on the screen. Only saved location can be displayed. The oscilloscope can display all reference waveforms at the same time.

Adjust REF Waveform

1. Please refer to the “Display REF Waveform” above to display the desired reference waveform.
2. Press the **Scale** and **Position** softkey and turn the **Universal Knob** to adjust the vertical scale and position of the reference waveform. The vertical scale and position information display at the middle of the screen.

The initial values display at the middle of the screen is the setup when the reference waveform is saved.

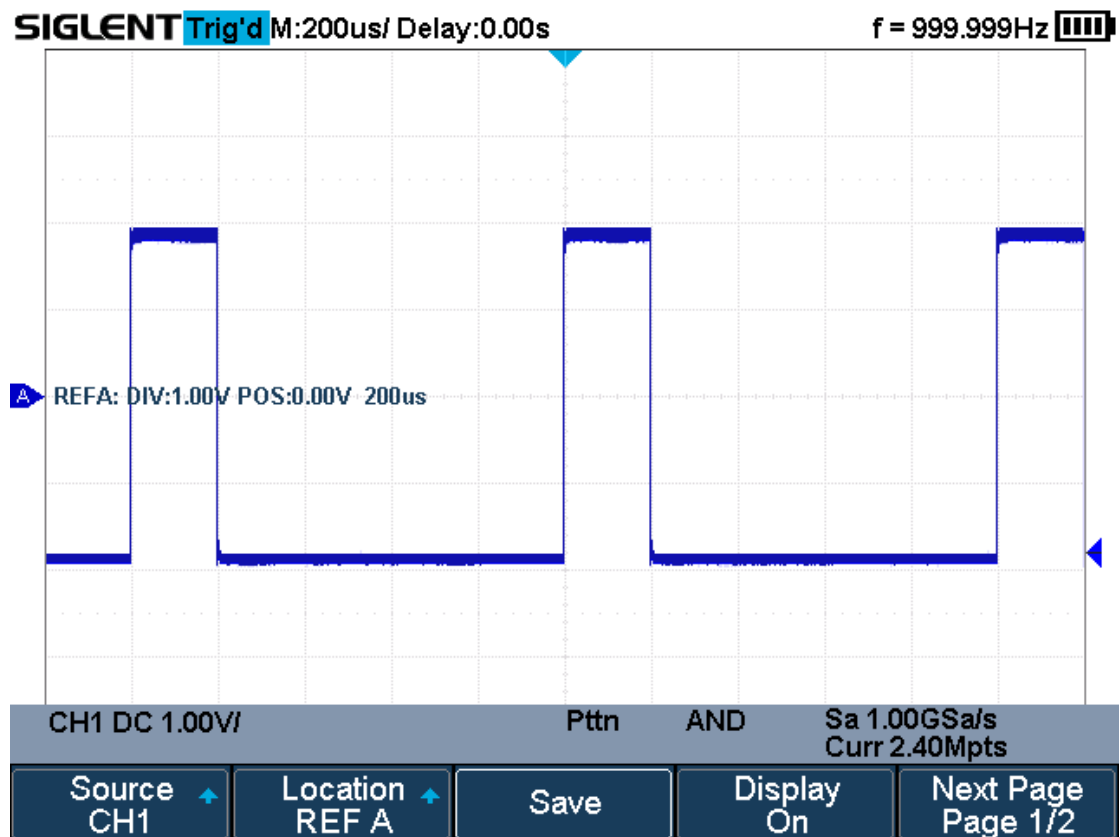

Figure 61 Reference Waveform

Clear REF Waveform

The oscilloscope does not have the “Clear” option under the REF WAVE function menu. To clear the appointed reference waveform, you can save a new reference waveform to the same location to cover it. Or follow the **Shift** + **Cursors** → **Recall** → **Type** and select **Security Erase** to clear the stored waveform.

Math

The oscilloscope supports many math operations between analog channels including addition (+), subtraction (-), multiplication (*), division (/), FFT, differential (d/dt), integral ($\int dt$), square root ($\sqrt{\quad}$). The resulting math waveform is displayed in white and labeled with "M". You can use cursors to measure it.

The contents of this chapter:

- ◆ Units for Math Waveforms
- ◆ Math Operators

Note: if the analog channel or the math function is cut off (waveforms do not display on the screen completely), the resulting math will also be cut off.

Units for Math Waveforms

Use the channel function menu to set the unit of each channel to "V" or "A". The oscilloscope math operation includes units as below:

Math Operation	Unit
Addition (+) or subtraction (-)	V, A
multiplication (*)	V ² , A ² or W
division (/)	None, V*A ⁻¹ or V ⁻¹ *A
FFT	dBVrms, Vrms, dBm, dBArms, Arms
differential (d/dt)	V*S ⁻¹ or A*S ⁻¹
integral (∫dt)	Wb, C
square root (√)	V ^{1/2} or A ^{1/2}

Math Operators

The oscilloscope supports math count operation (Addition, subtraction, multiplication, division), FFT (Fourier transform) operation and math function operation (differential, integral, square root).

Addition or Subtraction

Math operators perform arithmetic operations add or subtract operation on any two analog input channels. When you select addition or subtraction, the **Source A** and **Source B** values are added or subtracted point by point, and the result is displayed.

1. Press the **Shift** and **Measure** button on the front panel to enter the MATH function menu.
2. Press the **Source A** and **Source B** softkey respectively, and then turn the **Universal Knob** to select the source for math operation. Addition or Subtraction can be applied between analog channels.
3. Press the **Operator** softkey and then turn the **Universal Knob** to select **+** or **-** to make addition or subtraction operation. The resulting math waveform is displayed in white and labeled with "M" .

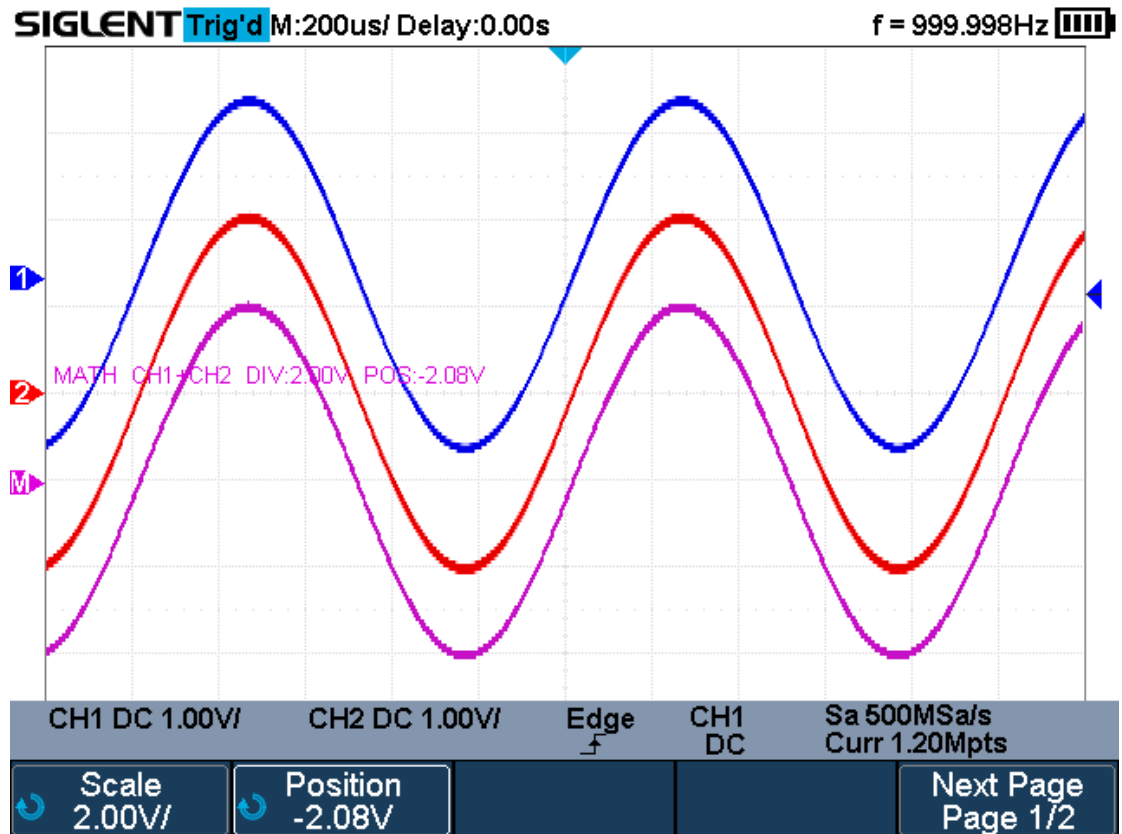

Figure 62 C1+C2 Waveform

- If you want to invert the math waveform, press the **Invert** button and set the option to **On** to invert the display of the math waveform.

Multiplication and Division

Math operators perform arithmetic operations multiplication or division operation on any two analog input channels. When you select multiplication or division, the **Source A** and **Source B** values are multiplied or divided point by point and the result is displayed.

1. Press the **Shift** and **Measure** button on the front panel to enter the MATH function menu.
2. Press the **Source A** and **Source B** softkey respectively, and then turn the **Universal Knob** to select the source for math operation. Multiplication or Division can be applied between analog channels.
3. Press the **Operator** softkey and then turn the **Universal Knob** to select * or / to make multiplication or division operation. The resulting math waveform is displayed in white and labeled with "M".

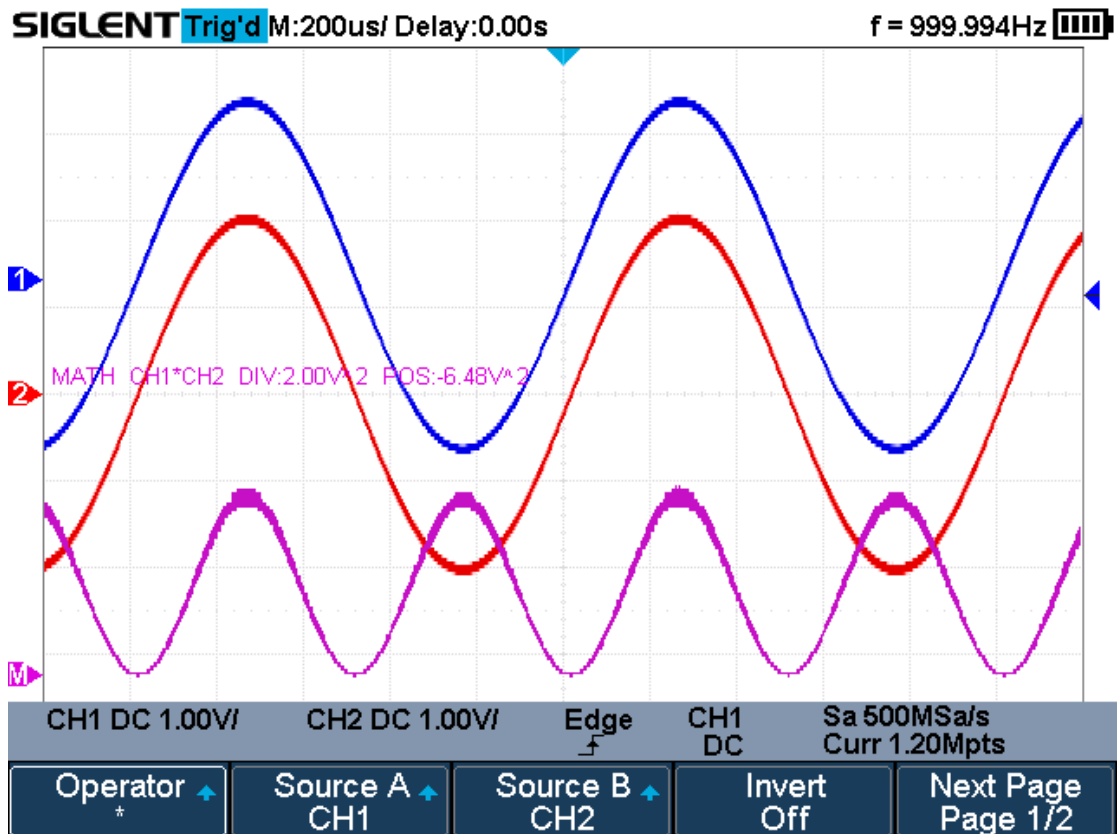

Figure 63 C1*C2 Waveform

4. If you want to invert the math waveform, press the **Invert** button and set the option to **On** to invert the display of the math waveform.

FFT Operation

FFT is used to compute the fast Fourier transform using analog input channels. FFT takes the digitized time record of the specified source and transforms it to the frequency domain. When the FFT function is selected, the FFT spectrum is plotted on the oscilloscope display as magnitude in dBV versus frequency. The readout for the horizontal axis changes from time to frequency (Hertz) and the vertical readout changes from V to dB.

FFT operation can facilitate the following works:

- ◆ Measure harmonic components and distortion in the device under test
- ◆ Measure the characteristics of the noise in DC power
- ◆ Analyze vibration

To display a FFT waveform:

1. Press the **Shift** and **Measure** button on the front panel to open the MATH function menu.
2. Press the **Operator** softkey and then turn the **Universal Knob** to select **FFT**. The resulting math waveform is displayed in white and labeled with "M" .



Figure 64 FFT Menu

3. Press the **Source** softkey, and then turn the **Universal Knob** to select the source to do FFT operation. Analog channels can be used as the source.
4. Press the **Config** softkey to enter CONFIG menu.



Figure 65 FFT CONFIG Menu

- Press the **Maximum points** softkey, and then turn the **Universal Knob** to select the Maximum points.
- Press the **Window** softkey, and then turn the **Universal Knob** to select an appropriate window.

Spectral leakage can be considerably decreased when a window function is used. The oscilloscope provides five windows (Rectangle, Blackman, Hanning, Hamming and Flattop) which have different characteristics and are applicable to measure different waveforms. You need to select the window function according to different waveforms

and their characteristics. Please read the table below carefully to make an appropriate option according to the input signal.

Window	Applications and Characteristics
Rectangle	These are normally used when the signal is transient (completely contained in the time-domain window) or known to have a fundamental frequency component that is an integer multiple of the fundamental frequency of the window. Signals other than these types will show varying amounts of spectral leakage and scallop loss, which can be corrected by selecting another type of window.
Hanning	These reduce leakage and improve amplitude accuracy. However, frequency resolution is also reduced.
Hamming	These reduce leakage and improve amplitude accuracy. However, frequency resolution is also reduced.
Flat Top	This window provides excellent amplitude accuracy with moderate reduction of leakage, but with reduced frequency resolution.
Blackman	It reduces the leakage to a minimum, but with reduced frequency resolution.

- Press the **Auto Set** softkey to automatically set the appropriate parameters for the FFT measurement.
- Press the **Display** softkey to select **Split Screen**, **Full Screen** or **Exclusive** display mode.

Split Screen: Time domain waveform and frequency domain waveform are displayed separately. The time domain waveform is on the upper half screen, while the frequency domain waveform is located within the lower half of the display. In Split mode, if Zoom is enabled, the zoom waveform and the frequency domain waveform are displayed on the lower half screen together.

Full Screen: Time-domain waveform and frequency-domain waveform are displayed together.

Exclusive: Only the frequency-domain waveform is displayed.

- Press the **Mode** softkey to select **Normal**, **Max-Hold** or **Average**. When you select **Average**, it is necessary to set the average times.

5. Press the **Vertical** softkey to enter VERTICAL menu.



Figure 66 VERTICAL Menu

- Press the **Scale** softkey, and then turn the **Universal Knob** to select the desired vertical FFT scale
- Press the **Ref Level** softkey, and then turn the **Universal Knob** to select the desired vertical FFT offset.
- Press the **Unit** softkey to select the unit of vertical axis. The vertical axis units can be dBVrms, dBm, Vrms or dBArms, Arms, which use a

logarithmic scale or a linear scale to display vertical amplitude respectively.

- Press the **Ext Lode** softkey and then turn the **Universal Knob** to select the external load value.

6. Press the **Horizontal** softkey to enter HORIZONTAL menu.

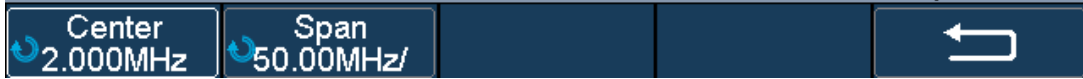

Figure 67 HORIZONTAL Menu

- Press the **Center** softkey, and then turn the **Universal Knob** to select the desired center frequency.
 - Press the **Span** softkey, and then turn the **Universal Knob** to select the desired span frequency.
7. Press the **Tools** softkey to enter TOOLS menu. Press **Type** softkey to select the type of tools. The type of the tools can be **Peaks**, **Markers**, or **Off**.

Peaks: Automatically mark the peak of the current FFT waveform according to the search configuration.

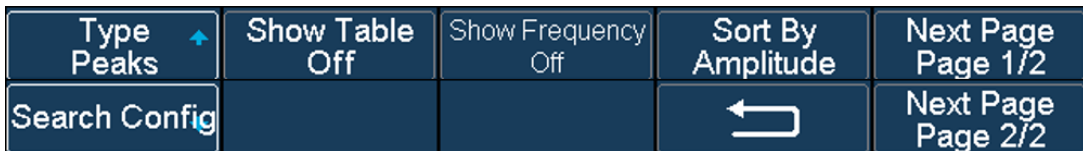

Figure 68 FFT Peaks Menu

- Press the **Show Table** softkey to display a table of peak, and press **Show Frequency** softkey to display the frequency value of the peak. Press the **Sort By** softkey continuously to set the table sorting by Amplitude or Frequency.
- Press the **Search Config** softkey to set search configuration.



Figure 69 SEARCH Menu

- Press the **Threshold** softkey and turn the **Universal knob** to set the minimum peak amplitude. Only peaks larger than the peak limit can be judged as peaks.
- Press the **Excursion** softkey and turn the **Universal knob** to set the difference between the peak value and the minimum Amplitude on both sides. Only when the difference is greater than the peak value of peak offset can the peak value be determined.

Markers: Customize the marker locations on the FFT waveform based on search configuration.

Type Markers	Marker Control	Search Config	Markers on Peaks	Next Page Page 1/3
Markers on Harmonics	Show Table Off	Show Frequency Off	Show Delta Off	Next Page Page 2/3
			←	Next Page Page 3/3

Figure 70 FFT Markers Menu

- Press **Markers Control** softkey to enter MARKER Menu.

Marker No.1	Show Marker On	Frequency 8.423MHz	Next Peak	Next Page Page 1/2
Next Amplitude			←	Next Page Page 2/2

Figure 71 Marker Control Menu

- Press the **Marker** softkey continuously to select the marker number from NO.1~NO.8
 - Press the **Show Marker** softkey continuously to turn on or off the selected mark.
 - Press the **Frequency** softkey to set the frequency value of the selected marker.
 - Press the **Next Peak** softkey to move the selected mark to the next peak. And press the **Next Amplitude** softkey to move the selected marker to the next peak with lower amplitude.(Up to 20 peaks are supported)
- Press the **Search Config** softkey to enter the SEARCH menu. Similar to the **Search Config** for peaks.
 - Press the **Markers on Peaks** softkey to set the markers on peaks, and press the **Markers on Harmonics** softkey to set the markers on harmonics.
 - Press the **Show Table** softkey to show the amplitude of the markers; press the **Show Frequency** softkey to show the frequency value of the markers, and press the **Show Delta** softkey to show the delta amplitude between markers.

The following figure shows the FFT waveform displayed on the split screen and the peak tool is turned on:

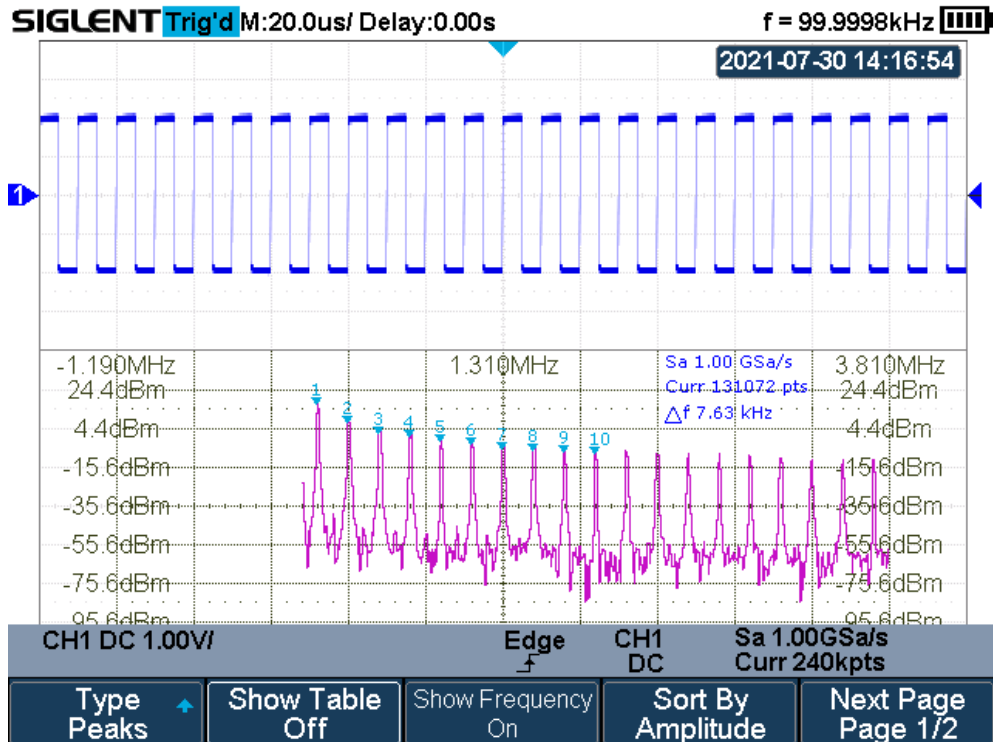

Figure 72 FFT Waveform

Note:

- Signals with DC components or deviation would cause error or deviation of the FFT waveform components. To reduce the DC components, set the Channel **Coupling** to AC.
- To reduce the random noise and aliasing frequency components of repetitive or single pulse, set the **Acquisition** of the oscilloscope to Average.

To measure FFT waveform:

To make cursor measurements, press the **Cursors** button, and then press the **Mode** softkey to select **On** to turn the cursors, Use the X1 and X2 cursors to measure frequency values and the difference between two frequency values (ΔX). Use the Y1 and Y2 cursors to measure amplitude in dB and difference in amplitude (ΔY).

You can find the frequency value at the first occurrence of the waveform maximum by using the X at Max Y measurement.

Note: please refer to the cursors chapter to obtain the method of using cursors.

Math Function Operation

The oscilloscope supports math function operation including differential (d/dt), integral (\int) and square root ($\sqrt{\quad}$).

Differentiate

d/dt (differentiate) calculates the discrete time derivative of the selected source.

$$d_i = \frac{y(i+dx) - y(i)}{dx}$$

Where:

- d = differential waveform
- y = voltage value of data point
- i = data point index
- dx = point- to- point time difference

The dx option under d/dt math function operation menu indicates data points. The minimum value is 4, and the unit is points.

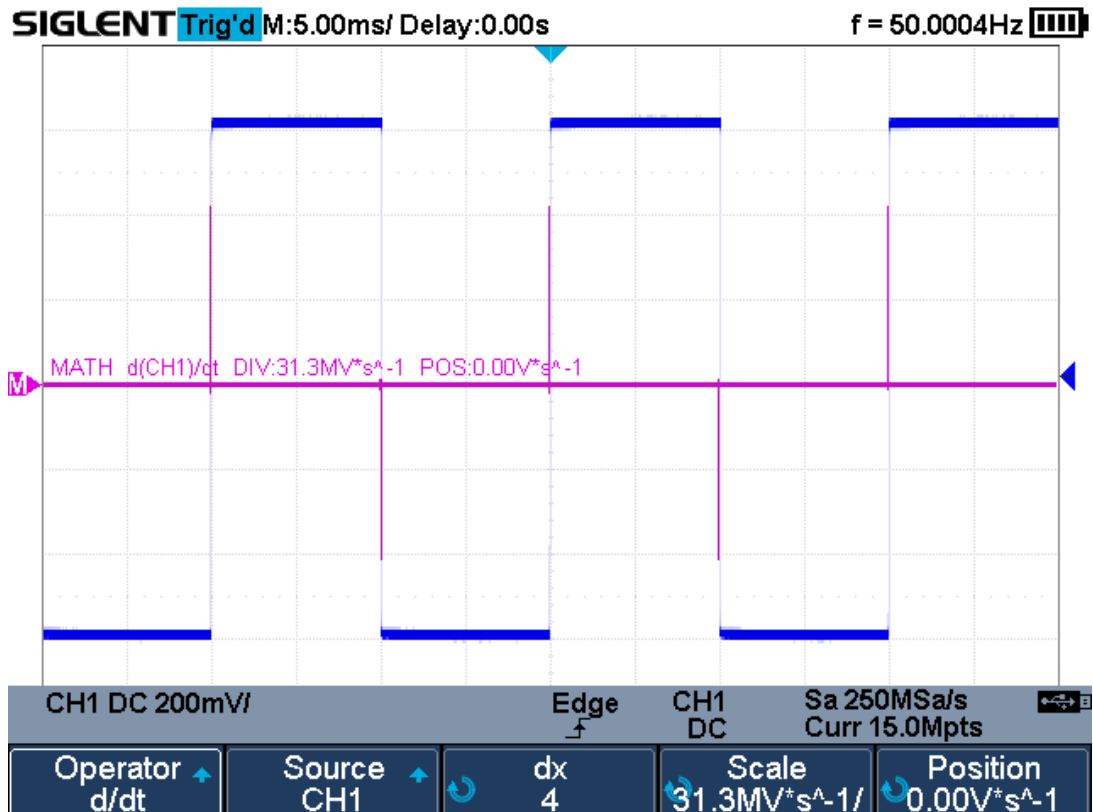

Figure 73 Difference Function Operation

You can use differentiate to measure the instantaneous slope of a waveform. For example, the slew rate of an operational amplifier may be measured using the differentiate function

Note: Because differentiation is very sensitive to noise, it is helpful to set acquisition mode to **Average**.

Integrate

dt (integrate) calculates the integral of the selected source. You can use integrate to calculate the energy of a pulse in volt- seconds or measure the area under a waveform.

dt plots the integral of the source using the "Trapezoidal Rule". The equation is:

$$I_n = c_0 + \Delta t \sum_{i=0}^n y_i$$

Where:

- I = integrated waveform
- Δt = point- to- point time difference
- y = channel 1, 2, 3, or 4 data points
- c_0 = arbitrary constant
- i = data point index

The integrate operator provides an **Offset** softkey that lets you enter a DC offset correction factor for the input signal. Small DC offset in the integrate function input (or even small oscilloscope calibration errors) can cause the integrate function output to "ramp" up or down. This DC offset correction lets you level the integrate waveform.

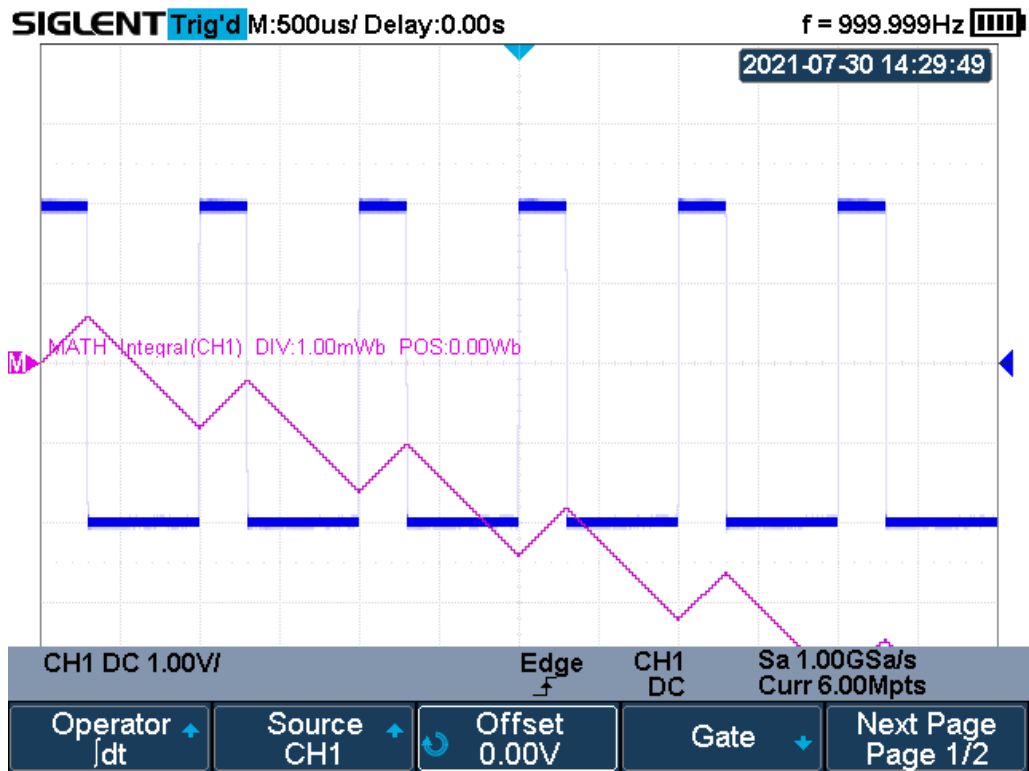

Figure 74 Integral without Offset

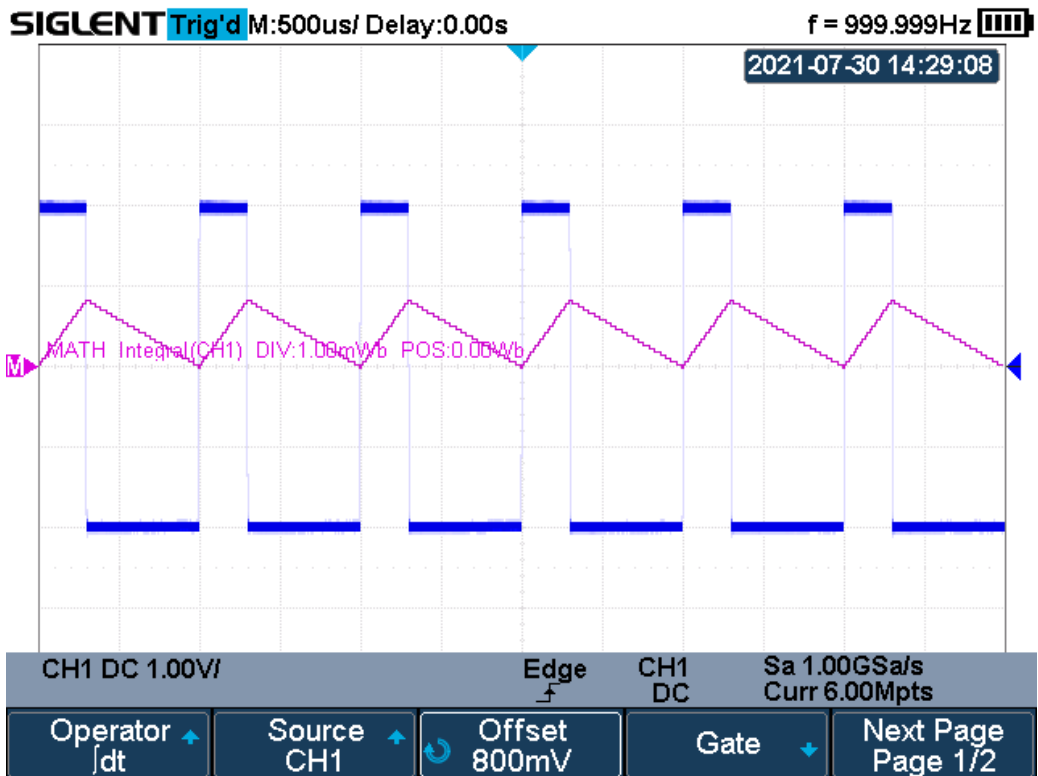

Figure 75 Integral with Offset

Square Root

Square root ($\sqrt{\quad}$) calculates the square root of the selected source.

Where the transform is undefined for a particular input, holes (zero values) appear in the function output.

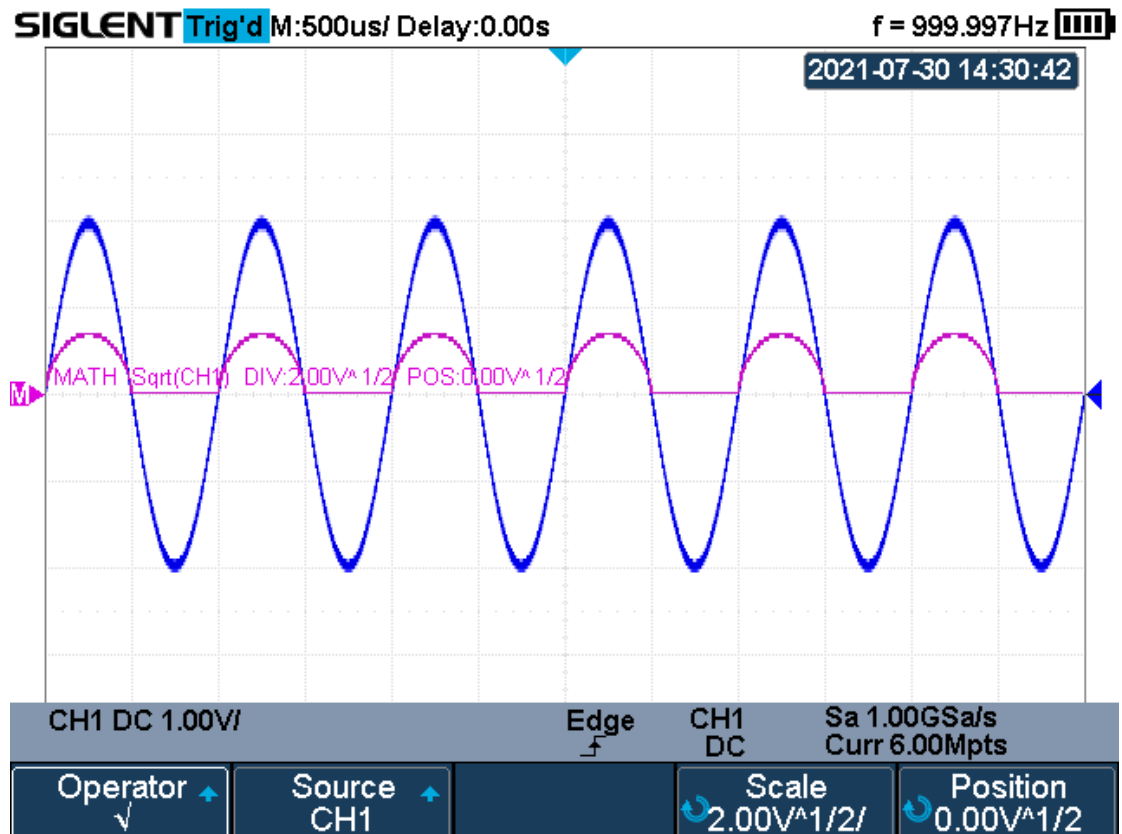

Figure 76 Square Root

Cursors

Cursors are horizontal and vertical markers that indicate X- axis values and Y- axis values on a selected waveform source. You can use cursors to make custom voltage, time measurements on oscilloscope signals.

X Cursors

X cursors are vertical dashed lines that adjust horizontally and can be used to measure time (when the source is FFT waveform, X cursors measure frequency).

X1 cursor is the left (default position) vertical dotted line; it can be moved to any place of the screen.

X2 cursor is the right (default position) vertical dotted line; it can be moved to any place of the screen.

Use the **Universal Knob** to set the X1 and X2 cursor values and the values are displayed in the cursors box in the upper-left corner of the screen along with the difference between X1 and X2 (ΔT) and $1/\Delta T$.

When set cursor type to X2-X1, use **Universal Knob** will move the X1 and X2 cursors together. The value under the menu option is the difference between the X1 and X2 cursors.

Y Cursors

Y cursors are horizontal dotted lines that adjust vertically and can be used to measure voltage (V) or current (A). When the cursors source is the math function, the unit will match the math function.

Y1 cursor is the top (default position) horizontal dotted line; it can be moved to any vertical place of the screen.

Y2 cursor is the down (default position) horizontal dotted line; it can be moved to any vertical place of the screen.

Use the **Universal Knob** to set the Y1 and Y2 cursor values and the values are displayed in the cursors box in the top left corner of the screen along with the difference between Y1 and Y2 (ΔY).

When set cursor type to Y2-Y1, use **Universal Knob** will move the Y1 and Y2 cursors together. The value under the menu option is the difference between the Y1 and Y2 cursors.

Make Cursor Measurements

1. Press the **Cursors** button on the front panel to enter the CURSOR function menu.
2. Press the **Mode** softkey and set the cursors mode to **Manual** or **Track**.
3. Press the **Source** softkey, and then use the **Universal Knob** to select the desired source. Only analog channels, math waveforms and reference waveforms that are displayed are available for cursors.
4. Press the **X Ref** and **Y Ref** softkey to set the reference of X cursors and Y cursors.
 - **Position:** when the horizontal/vertical scale is changed, the X/Y cursors remain fixed to the grid position on the display.
 - **Delay/Offset:** when the horizontal/vertical is changed, the value of X/Y cursors remain fixed.
5. To make cursor measurements:
 - To measure the horizontal time, use the **Universal Knob** to move the X1 and X2 cursors to desired place. If necessary, set the cursor type to **X2-X1**, move X1 and X2 cursors together.
 - To measure vertical voltage or current, use the **Universal Knob** to move the Y1 and Y2 cursors to desired place. If necessary, set the cursor type to "Y2-Y1", move Y1 and Y2 cursors together.
 - To adjust the transparency of the cursors message box, press the **Display/Persist** button and go to the second page, press the **Transparence** (20% to 80%) softkey and then turn the **Universal Knob** to adjust the transparence to the desired value.

Cursor examples:

Use cursors to measure pulse width:

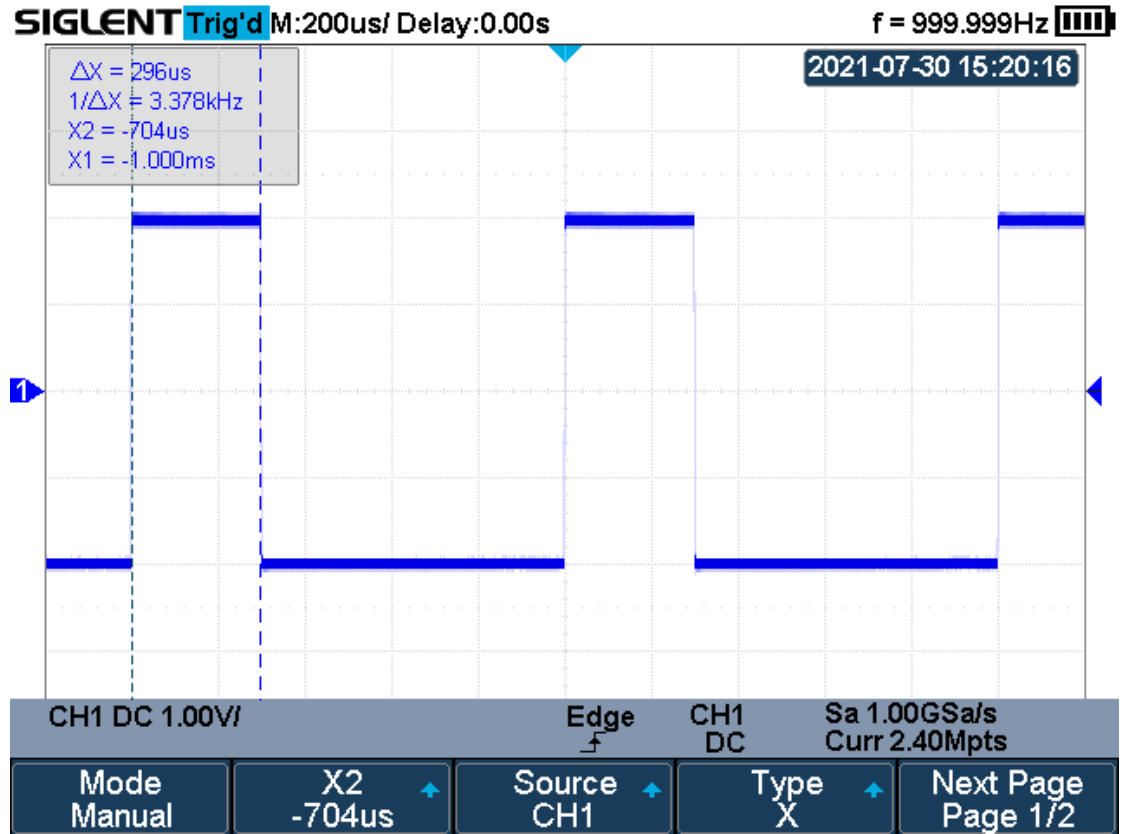

Figure 77 Measure Pulse Width

Measure

The oscilloscope provides measurements of 38 waveform parameters and the statistics. It contains voltage, time and delay parameters.

Voltage and time parameters are under Type option. The results of the last four selected measurements are displayed at the bottom of screen and above the menu. Delay parameters are under the **All Measure** submenu. Set the Delay option to On to display all the delay parameters.

The contents of this chapter:

- ◆ Type of measurement
- ◆ Add measurement
- ◆ Clear measurement
- ◆ All measurement
- ◆ Gate measurement

Type of Measurement

Voltage Measurements

Voltage measurements include 17 kinds of voltage parameter measurements.

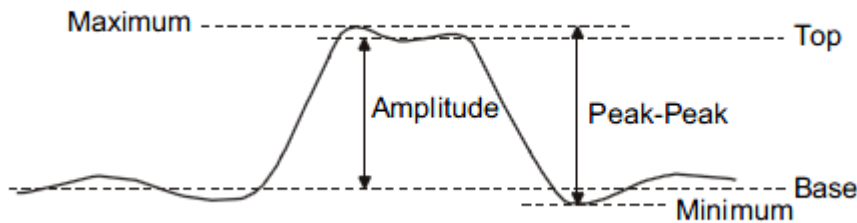

Figure 78 Voltage Measurements

1. **Peak-Peak:** Difference between maximum and minimum data values.
2. **Maximum:** Highest value in input waveform.
3. **Minimum:** Lowest value in input waveform.
4. **Amplitude:** Difference between top and base in a bimodal signal, or between max and min in a unimodal signal.
5. **Top:** Value of most probable higher state in a bimodal waveform.
6. **Base:** Value of most probable lower state in a bimodal waveform.
7. **Mean:** Average of all data values
8. **Cycle mean:** Average of data values in the first cycle.
9. **Stdev:** Standard deviation of all data values
10. **Cycle Stdev:** Standard deviation of all data values in the first cycle
11. **Rms:** Root mean square of all data values.
12. **Cycle RMS:** Root mean square of all data values in the first cycle.
13. **Overshoot:** Overshoot is distortion that follows a major edge transition expressed as a percentage of Amplitude. ROV means rising edge overshoot and FOV means falling edge overshoot.

$$\text{Rising edge overshoot} = \frac{\text{local Maximum} - \text{D Top}}{\text{Amplitude}} \times 100$$

$$\text{Falling edge overshoot} = \frac{\text{Base} - \text{D local Minimum}}{\text{Amplitude}} \times 100$$

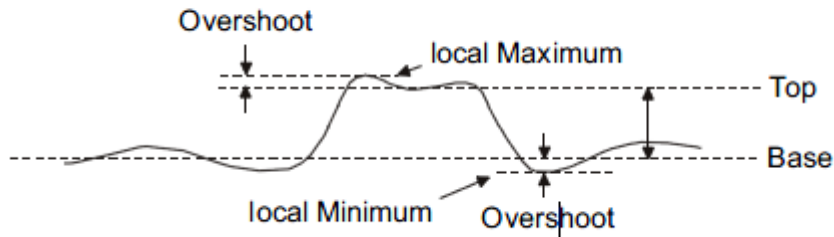

Figure 79 Overshoot

14. **Preshoot:** Preshoot is distortion that precedes a major edge transition expressed as a percentage of Amplitude. The X cursors show which edge is being measured (edge closest to the trigger reference point).

$$\text{Rising edge preshoot} = \frac{\text{local Minimum} - D \text{ Top}}{\text{Amplitude}} \times 100$$

$$\text{Falling edge preshoot} = \frac{\text{Base} - D \text{ local Minimum}}{\text{Amplitude}} \times 100$$

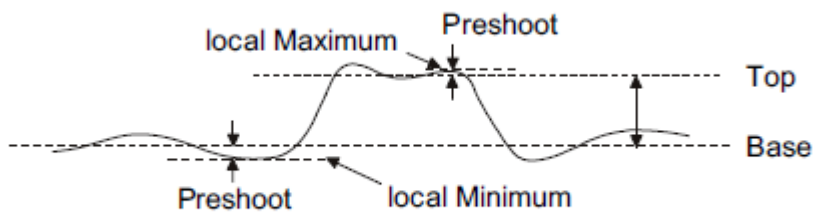

Figure 80 Preshoot

15. **Level@X:** the voltage value between the trigger point and the vertical position of the channel

Time Measurements

Time measurements include 11 kinds of time parameter measurements.

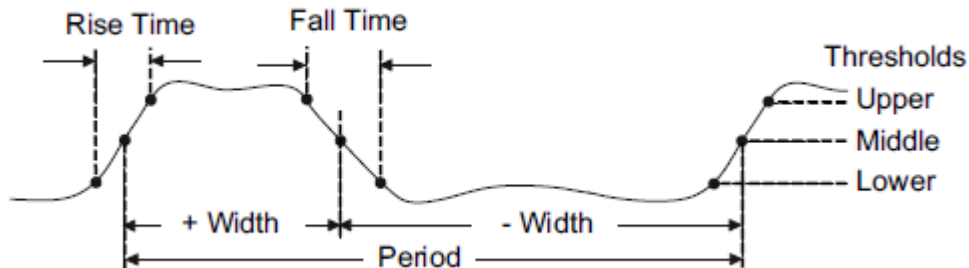

Figure 81 Time Measurements

1. **Period:** Period for every cycle in waveform at the 50% level, and positive slope.
2. **Frequency:** Frequency for every cycle in waveform at the 50% level, and positive slope
3. **+ Width:** Width measured at 50% level and positive slope.
4. **- Width:** Width measured at 50% level and negative slope.
5. **Rise Time:** Duration of rising edge from 10-90%.
6. **Fall Time:** Duration of falling edge from 90-10%.
7. **BWid:** Time from the first rising edge to the last falling edge, or the first falling edge to the last rising edge at the 50% crossing.
8. **+ Duty:** Ratio of positive width to period.
9. **- Duty:** Ratio of negative width to period.
10. **Delay:** Time from the trigger to the first transition at the 50% crossing.
11. **T@L:** Time from trigger of each transition at a specific level and slope, include: Current, Max, Min, Mean, and Std-dev.

Delay Measurements

Delay measurements measure the time different between arbitrary two channels, including 10 kinds of delay measurements.

1. **Phase:** Calculate the phase difference between two edges.
2. **FRFR:** Time between the first rising edges of the two channels.
3. **FRFF:** Time from the first rising edge of channel A to the first falling edge of channel B.
4. **FFFR:** Time from the first falling edge of channel A to the first rising edge of channel B.
5. **FFFF:** Time from the first falling edge of channel A to the first falling edge of channel B.
6. **FRLR:** Time from the first rising edge of channel A to the last rising edge of channel B.
7. **FRLF:** Time from the first rising edge of channel A to the last falling edge of channel B.
8. **FFLR:** Time from the first falling edge of channel A to the last rising edge of channel B.
9. **FFLF:** Time from the first falling edge of channel A to the last falling edge of channel B.
10. **Skew:** Time of source A edge minus time of nearest source B edge.

Add Measurement

Perform the steps below and select voltage or time parameters to make automatic measurement.

1. Press the **Measure** button on the front panel to enter the MEASURE function menu. At the same, the frequency and period are enabled with the current trigger channel, the statistics also was enabled.
2. Press the **Source** softkey, and then use the **Universal Knob** to select the desired channel. Only analog channels that are displayed are available for measurements.
3. To select and display measurement parameters. Press the **Type** softkey, and then turn the **Universal Knob** to select the desired measurement parameter.
4. Press the **Universal Knob** to add the measurement parameter, the parameters and value will be shown above the menu, and the statistics status will update.
5. To turn off the statistic function, press the **Statistics** softkey to select **Off**.

The measurement display area can display 4 measurement parameters at most, which will be arranged according to the selecting order. If add the fifth measurement parameter, it will delete the first measurement.

SIGLENT Trig'd M:200us/ Delay:0.00s f = 999.999Hz 

2021-07-30 15:24:42

CH1

<input checked="" type="checkbox"/> Peak-Peak	<input type="checkbox"/> Maximum	<input type="checkbox"/> Minimum	<input type="checkbox"/> Amplitude	<input type="checkbox"/> Top	<input type="checkbox"/> Base
<input type="checkbox"/> Mean	<input type="checkbox"/> Cycle mean	<input type="checkbox"/> Stdev	<input type="checkbox"/> Cycle Stdev	<input type="checkbox"/> RMS	<input type="checkbox"/> Cycle RMS
<input type="checkbox"/> FOV	<input type="checkbox"/> FPRE	<input type="checkbox"/> ROV	<input type="checkbox"/> RPRE	<input type="checkbox"/> Level@X	
<input checked="" type="checkbox"/> Period	<input checked="" type="checkbox"/> Freq	<input type="checkbox"/> +Width	<input type="checkbox"/> -Width	<input type="checkbox"/> Rise Time	<input type="checkbox"/> Fall Time
<input type="checkbox"/> BWidth	<input type="checkbox"/> +Duty	<input type="checkbox"/> -Duty	<input type="checkbox"/> Delay	<input type="checkbox"/> Time@Level	

Channel Delay

Source A	<input type="checkbox"/> CH1	<input type="checkbox"/> CH2			
Source B	<input type="checkbox"/> CH1	<input type="checkbox"/> CH2			
<input type="checkbox"/> Phase	<input type="checkbox"/> FRFR	<input type="checkbox"/> FRFF	<input type="checkbox"/> FFFR	<input type="checkbox"/> FFFF	<input type="checkbox"/> FRLR
<input type="checkbox"/> FRLF	<input type="checkbox"/> FFLR	<input type="checkbox"/> FFLF	<input type="checkbox"/> Skew		



Frequency
Reciprocal of period

Pk-Pk[1]=4.12V Prd[1]=1.00ms Freq[1]=1.00kHz

CH1 DC 1.00V/ Edge  CH1 DC Sa 1.00GSa/s
Curr 2.40Mpts

Source CH1	Type	Clear	Statistics Off	Next Page Page 1/2
---------------	------	-------	-------------------	-----------------------

Figure 82 Select the Measurement Parameter

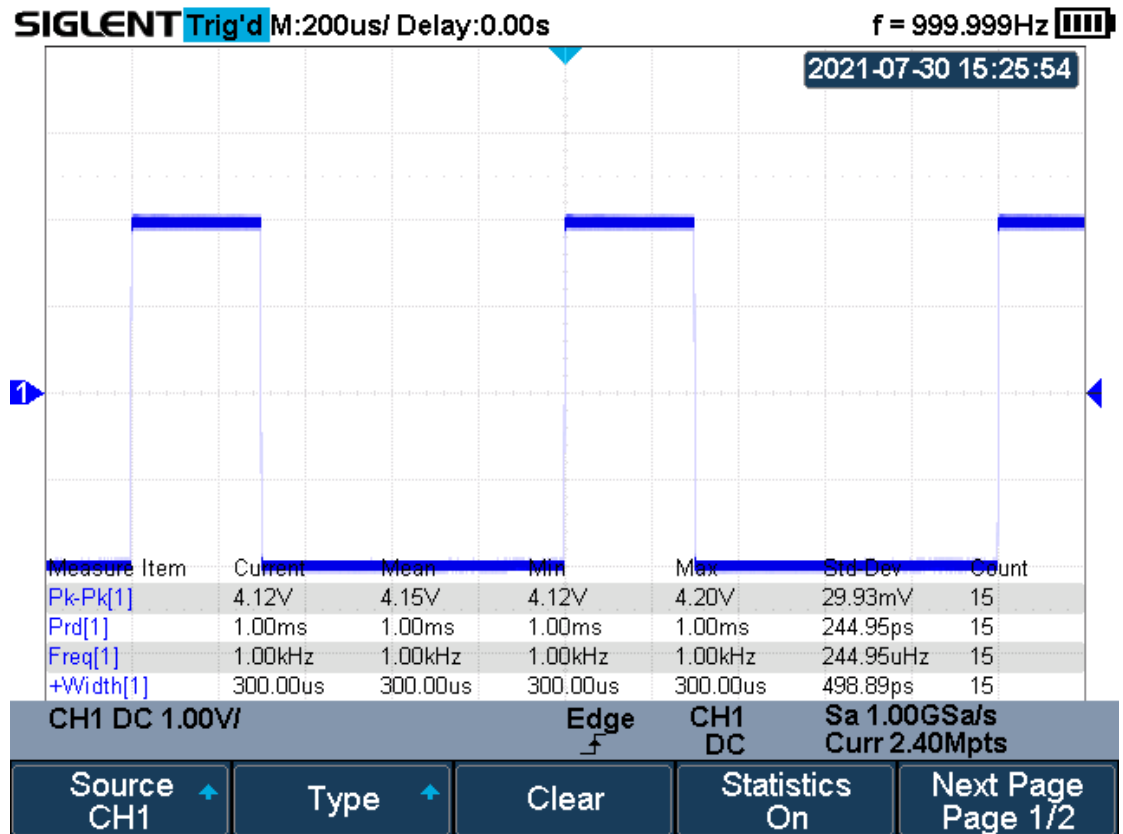

Figure 83 Added the Measurement

Note: if the parameter does not match the measure condition, it will display as "****" .

Clear Measurement

Press the **Clear** softkey to clear all the measurement parameters that are displaying on the screen.

All Measurement

All measurement could measure all the voltage and time parameters of the current measurement source and display the results on the screen.

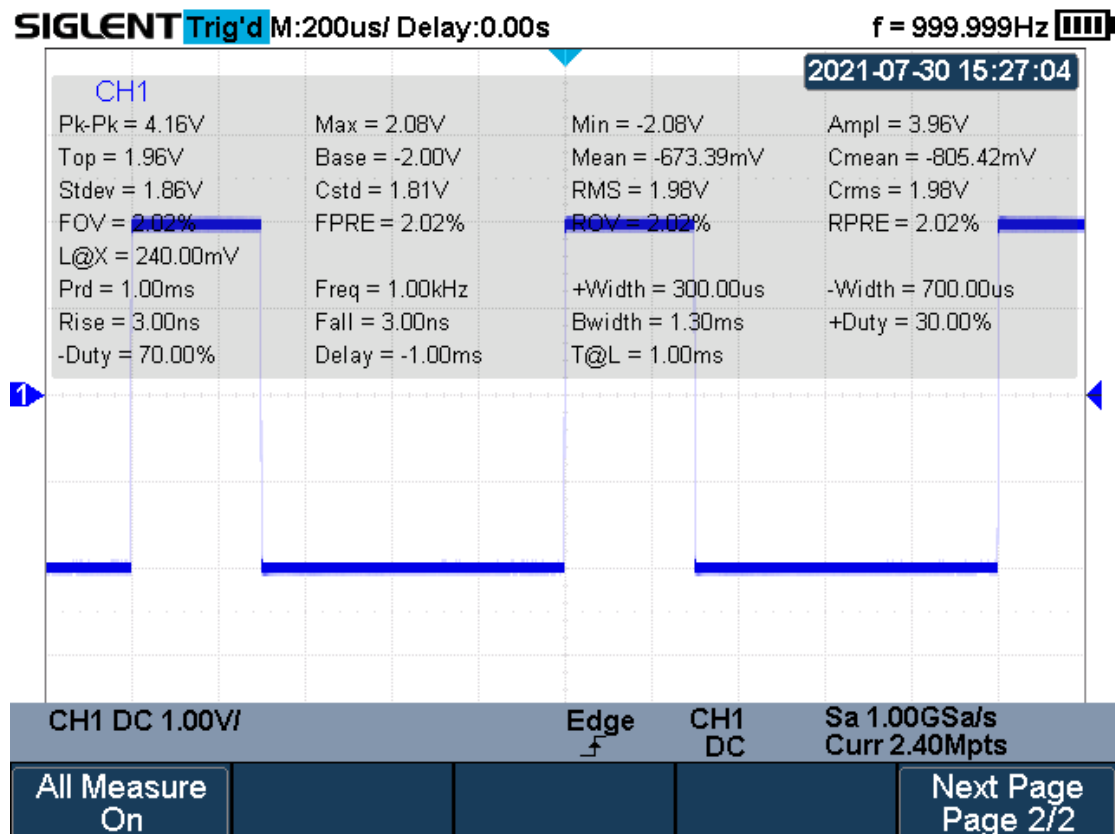

Figure 84 All Parameters Measurement

Do the following steps to make all parameters measurement.

1. Press the **Measure** button on the front panel to enter the MEASURE function menu.
2. Press the **All Measure** softkey to select **On**.

3. Press the **Source** softkey to select the measure source.

Gate Measurement

The SHS800X/SHS1000X support gate measurement and perform the selected measurement within the upper and lower limits of the gate. Setting the gate will affect the measurement of all voltage, time, and delay parameters.

1. Press **Measure** → **Gate** → **On** to open the gate measurement.
2. Press the **Gate A** to move the position of gate A by the **Universal Knob**.
3. Press the **Gate B** to move the position of gate B by the **Universal Knob**.
4. Press the **Gate A-B** to move the gate A and B positions of the simultaneously by the **Universal Knob**.

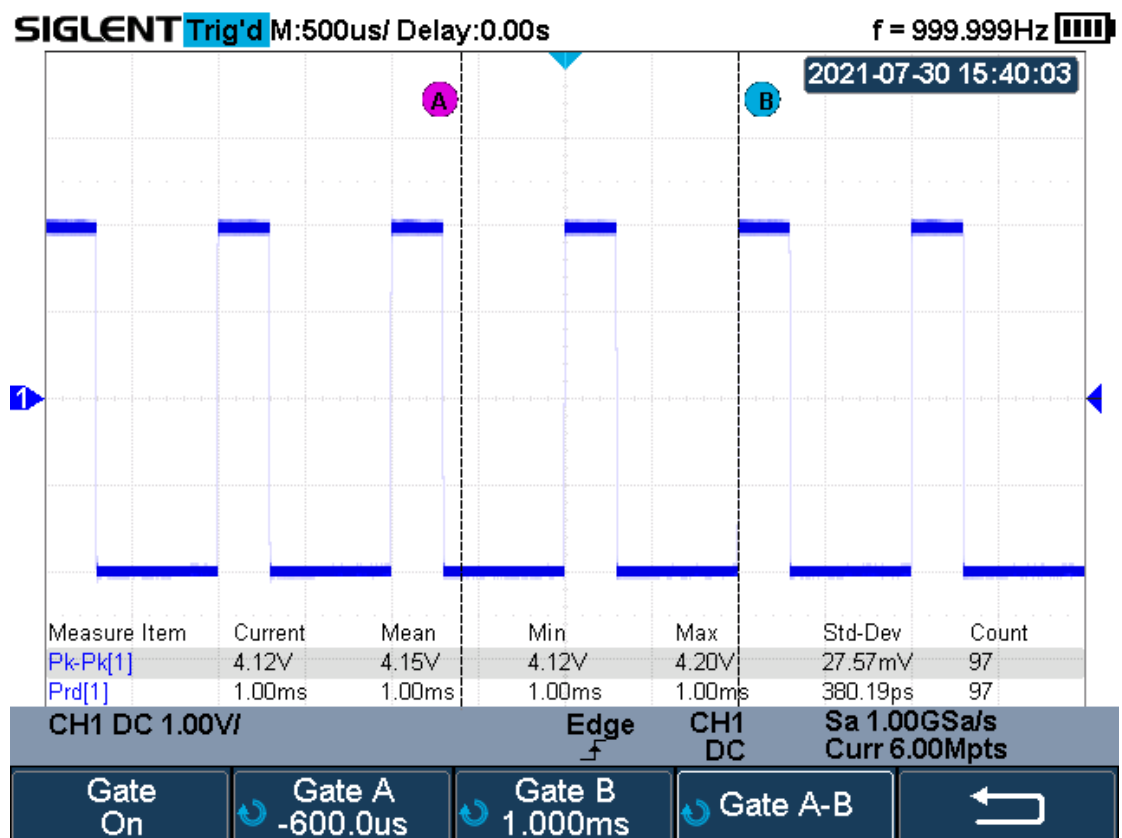

Figure 85 Gate Measurement

Display

You can set the display type, color, persistence, grid type, waveform intensity, grid brightness and transparenence.

The contents of this chapter:

- ◆ Display Type
- ◆ Color Grade
- ◆ Persistence
- ◆ Clear Display
- ◆ Grid Type
- ◆ Intensity
- ◆ Grid Brightness
- ◆ Transparenence
- ◆ LCD Light

Display Type

Press the **Display/Persist** button on the front panel, and then press the **Type** softkey to select **Vectors** or **Dots** display type.

- **Vectors:** the sample points are connected by lines and displayed. Normally, this mode can provide the most vivid waveform to view the steep edge of the waveform (such as square waveform).
- **Dots:** display the sample points directly. You can directly view each sample point and use the cursor to measure the X and Y values of the sample point.

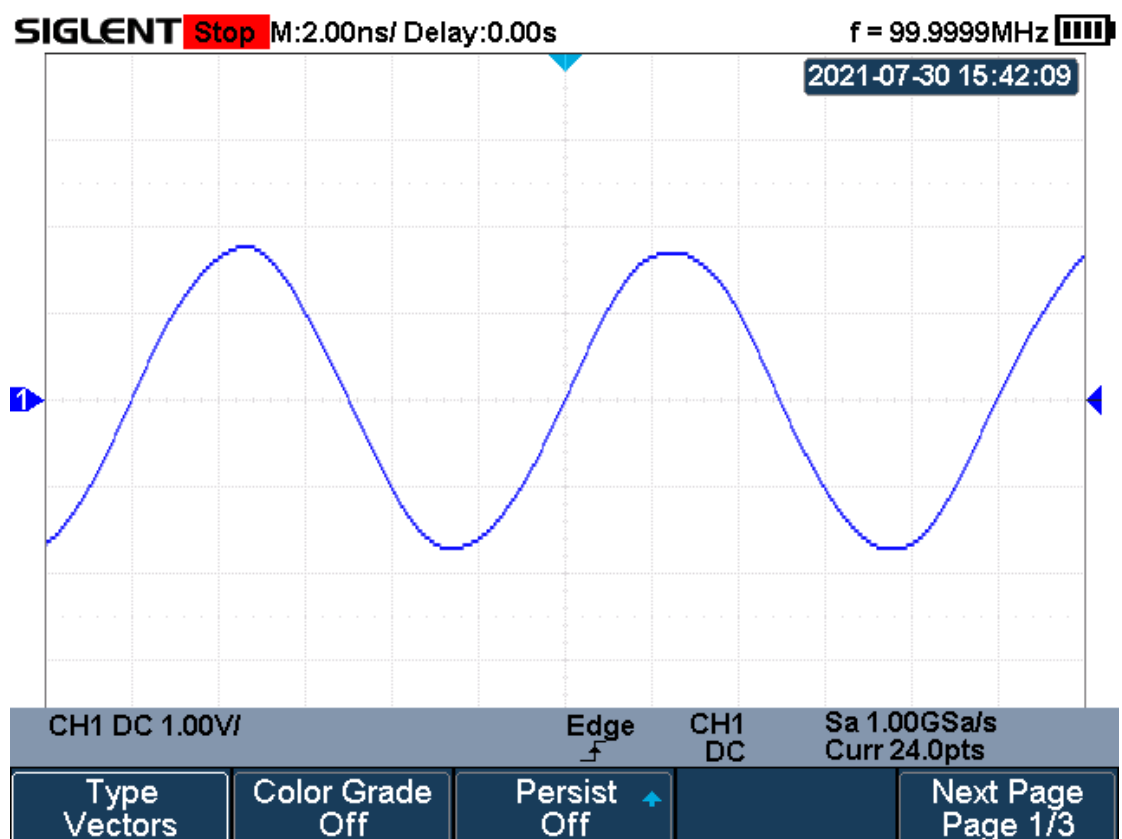

Figure 86 Vectors Display

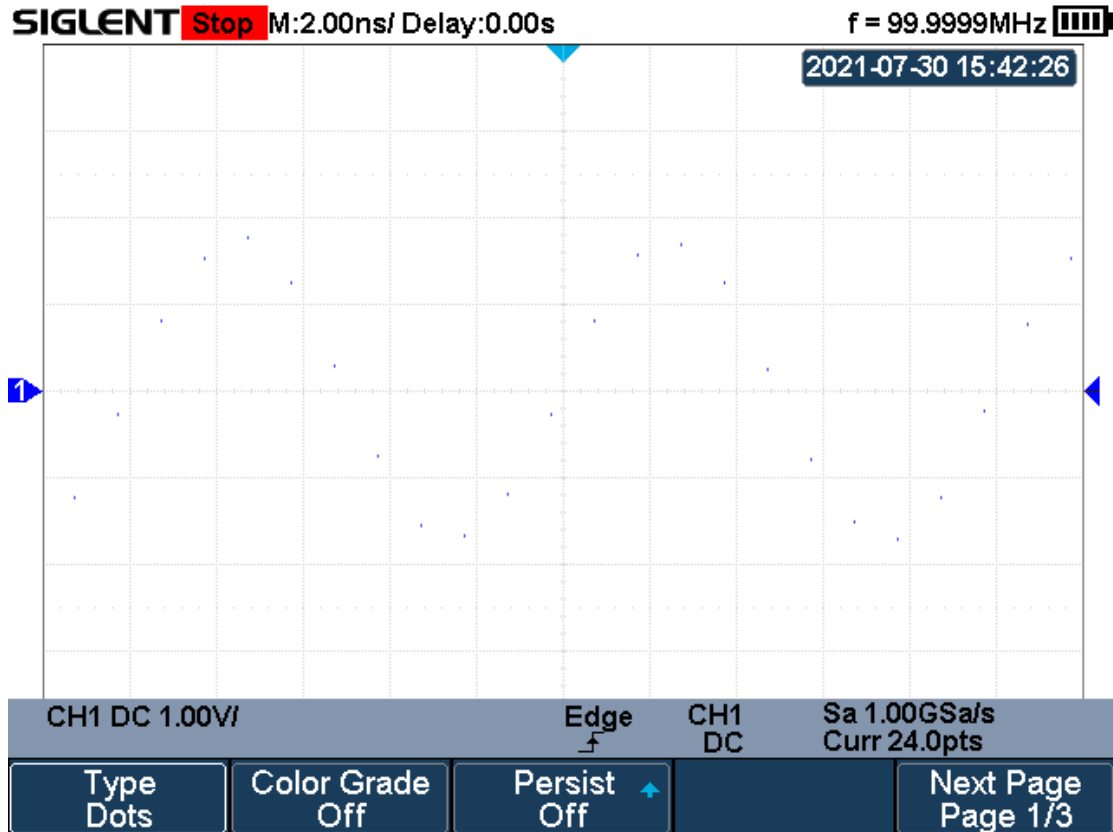

Figure 87 Dots Display

Color Grade

Color temperature adopts the change of waveforms' color to reflect the change of the waveforms' appearing probability. The greater the probability that the waveform appears, the warmer the color is; the smaller the waveform appears, the colder the color is.

The picture below shows the change of color from cold to warm. Press the **Display/Persist** button on the front panel, and then press the **Color Grade** softkey and set the option to **On** to turn on the color temperature function. You can compare the waveform's color with the picture below to just the probability that the waveform appears.

Cold Color \longrightarrow Warm Color

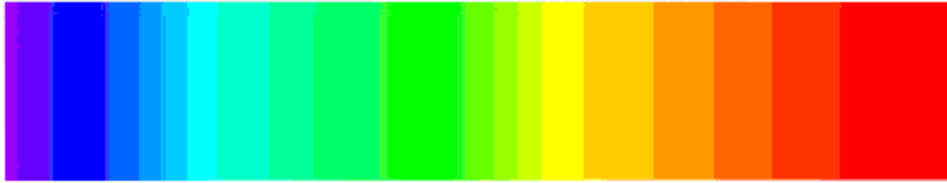

Figure 88 Color Temperature

Persistence

With persistence, the oscilloscope updates the display with new acquisitions, but does not immediately erase the results of previous acquisitions. All previous acquisitions are displayed with reduced intensity. New acquisitions are shown in their normal color with normal intensity.

Do the following steps to set and clear persistence:

1. Press the **Display/Persist** button on the front panel to enter the DISPLAY function menu.
2. Press the **Persist** softkey; then turn the **Universal Knob** to select the desired option.
 - **Off** —turn off persistence.
 - **Variable persistence time** (1 second, 5 seconds, 10 seconds, 30 seconds) — select different persistence time, the results of previous acquisitions are erased after a certain amount of time
 - **Infinite** —select “Infinite” Results of previous acquisitions are never erased. Use infinite persistence to measure noise and jitter, see the worst-case extremes of varying waveforms, look for timing violations, or capture events that occur infrequently.

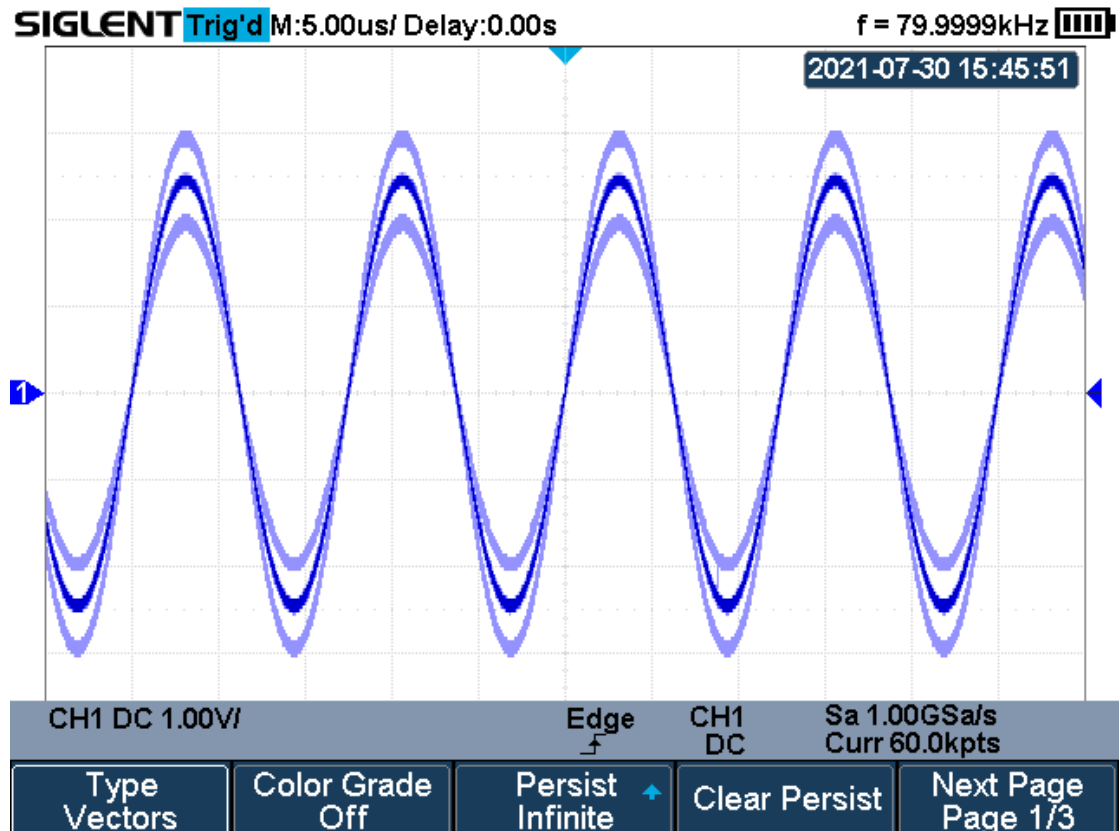

Figure 89 Persist Set to Infinite

3. When the **Persist** is **On**, press the **Clear Persist** softkey to erase the results of previous acquisitions from the display. The oscilloscope will start to accumulate acquisitions again.
4. To return to the normal display mode, turn off persist and the previous acquisitions will be clear at once.

Clear Display

Press the **Display/Persist** button on the front panel to enter the DISPLAY function menu; press the **Clear Display** softkey to clear all the waveforms displaying on the screen and acquire and display new waveforms.

Grid Type

To select grid type

1. Press the **Display/Persist** button on the front panel to enter the DISPLAY function menu.
2. Press the **Next Page** softkey to go to the second page of the Display function menu.
3. Press the **Grid** softkey; and then turn the **Universal Knob** to select the desired grid type. Press the **Grid** softkey continually can also select the grid type.

3 kinds of grid types are available. Select the grid type according to your really demand.



Display 12X8 grid type



Display 2X2 grid type



Display without grid

Intensity

Do the following steps to adjust waveform intensity:

1. Press the **Display/Persist** button on the front panel to enter the DISPLAY function menu.
2. Press the **Next Page** softkey to go to the second page of the Display function menu.
3. Press the **Intensity** softkey; and then turn the **Universal Knob** to select the desired value. The default value is 50%, and the range is from 0% to 100%.

Increasing the intensity lets you see the maximum amount of noise and infrequently occurring events. Reducing the intensity can expose more detail in complex signals as shown in the following figures.

Note: Waveform intensity adjustment affects analog channel waveforms only (not math waveforms, reference waveforms, digital waveforms, etc.).

Grid Brightness

Do the following steps to adjust the grid brightness:

1. Press the **Display/Persist** button on the front panel to enter the DISPLAY function menu.
2. Press the **Next Page** softkey to go to the second page of the Display function menu.
3. Press the **Graticule** softkey; and then turn the **Universal Knob** to select the desired value. The default value is 20%, and the range is from 0% to 100%.

Transparence

Transparence can be used to adjust the transparence of the message box of cursor, measure, Pass/Fail and all pop-up menus to an appropriate value to observe the date more conveniently.

Under Cursor or Measure or any other menu operation, if want to change the transparence of the message box, do the following steps:

1. Press the **Display/Persist** button on the front panel to enter the DISPLAY function menu.
2. Press the **Next Page** softkey to go to the second page of the Display function menu.
3. Press the **Transparence** softkey; and then turn the **Universal Knob** to select the desired value. The default value is 80%, and the range is from 20% to 80%.

LCD Light

Do the following steps to adjust the LCD Light:

1. Press the **Display/Persist** button on the front panel to enter the DISPLAY function menu.
2. Press the **Next Page** softkey to go to the third page of the Display function

- menu.
3. Press the **LCD Light** softkey; and then turn the Universal Knob to select the desired value.

Save and Recall

Oscilloscope setups, waveforms, pictures, and CSV files can be saved to internal oscilloscope memory or to a USB storage device. The saved setups, waveforms can be recalled later. The oscilloscope provides an USB Host interface on the side panel to connect an USB device for external storage.

The contents of this chapter

- ◆ Save Type
- ◆ Internal Save and Recall
- ◆ External Save and Recall
- ◆ Disk Management

Save Type

The oscilloscope supports setups, waveforms, images and CSV files storage. The default save type is setups.

1. Setups

It's the default storage type of the oscilloscope. It saves the settings of the oscilloscope in internal or external memory in "*.xml" format. The stored settings can be recalled.

2. Reference

The oscilloscope saves the waveform data in "*.REF" format. The data of the channel is your select channel. At recall, the data will be displayed on the screen by REFA or REFB.

3. BMP

The oscilloscope saves the screen image in "*.bmp" format. You can specify the file name and saving directory under the same directory using the same file name. The recall of image is not supported.

4. JPG

The oscilloscope saves the screen image in "*.jpg" format. You can specify the file name and saving directory under the same directory using the same file name. The recall of image is not supported.

5. PNG

The oscilloscope saves the screen image in "*.png" format. You can specify the file name and saving directory under the same directory using the same file name. The recall of image is not supported.

6. Binary

The oscilloscope saves the waveform data in "*.BIN" format. The data of all the channels turned on can be saved in the same file. The recall of binary is not supported.

7. CSV

The oscilloscope saves the waveform data in "*.CSV" format. The stored files contain the waveform data of the displayed analog channels and the main setting information of the oscilloscope. The recall of CSV file is not supported.

Set the save type to **CSV**, and set the **Param Save** option to **On** or **Off** to turn on the parameters storage function.

8. Matlab

The oscilloscope saves the waveform data in “*.DAT” format. The data of all the channels turned on can be saved in the same file. The recall of Matlab file is not supported.

9. To Default Key

The oscilloscope saves the factory config and user set config. Then you can select the default function is the factory config or user set config.

10. FileConverter

The mini tool converts stored binary files to CSV format for viewing with a spreadsheet program. It supports for file of waveform data (*.bin), file of sample logger (*.slg) and file of measure logger (*.mlg) to convert.

This is ideal when collecting large datasets. For a waveform frame with deep memory such as 12 Mpts, to save directly as a CSV file will take long time and will occupy a large amount of memory on a USB storage device. It's recommended to save the data as binary file and then convert it to CSV file on a computer.

Internal Save and Recall

In the following part, the internal save and recall method and procedures are introduced.

- **Save the specified oscilloscope setting to internal memory.**
 1. Connect the signal to the oscilloscope and obtain stable display.
 2. Press **Shift** and **Cursors** button on the front panel to enter the SAVE/RECALL function menu.
 3. Press the **Save** softkey to enter the SAVE function menu.
 4. Press the **Type** softkey, turn the **Universal Knob** to select **Setups**; and then press the knob to confirm.
 5. Press the **Press to Save** softkey to enter the disk manager, enter the "local" directory, and press the **Press to Save** softkey to save the current setup.

- **Load the specified type of file from internal memory.**

If want to recall the setup after having finished the steps above, please do the following steps:

1. Press the **Recall** softkey enter the RECALLING function menu.
2. Press the **Type** softkey and then turn the **Universal Knob** to select **Setups**; and then press the knob to confirm.
3. Press the **Press to Recall** softkey to enter the disk manager, recall the current setup form the appointed location. After a few seconds, it will pop-up the message "Recalled file successfully!"

Note: if need to delete a setup file in the memory, please save a new setup to the same location to overwrite it.

External save and recall

Before using external storage and recall, make sure that the USB flash device is connected correctly. External storage supports all the types of files in save, but in recall, images and CSV are not supported.

- Save the specified type of file to the external USB flash device.
1. Press the **Shift** and **Cursor** button on the front panel to enter the SAVE/RECALL function menu.
 2. Press the **Save** softkey to enter the SAVE menu.
 3. Press the **Type** softkey to select **Setups** and then press the knob to confirm.
 4. Press the **Press to Save** softkey to enter the disk manager.

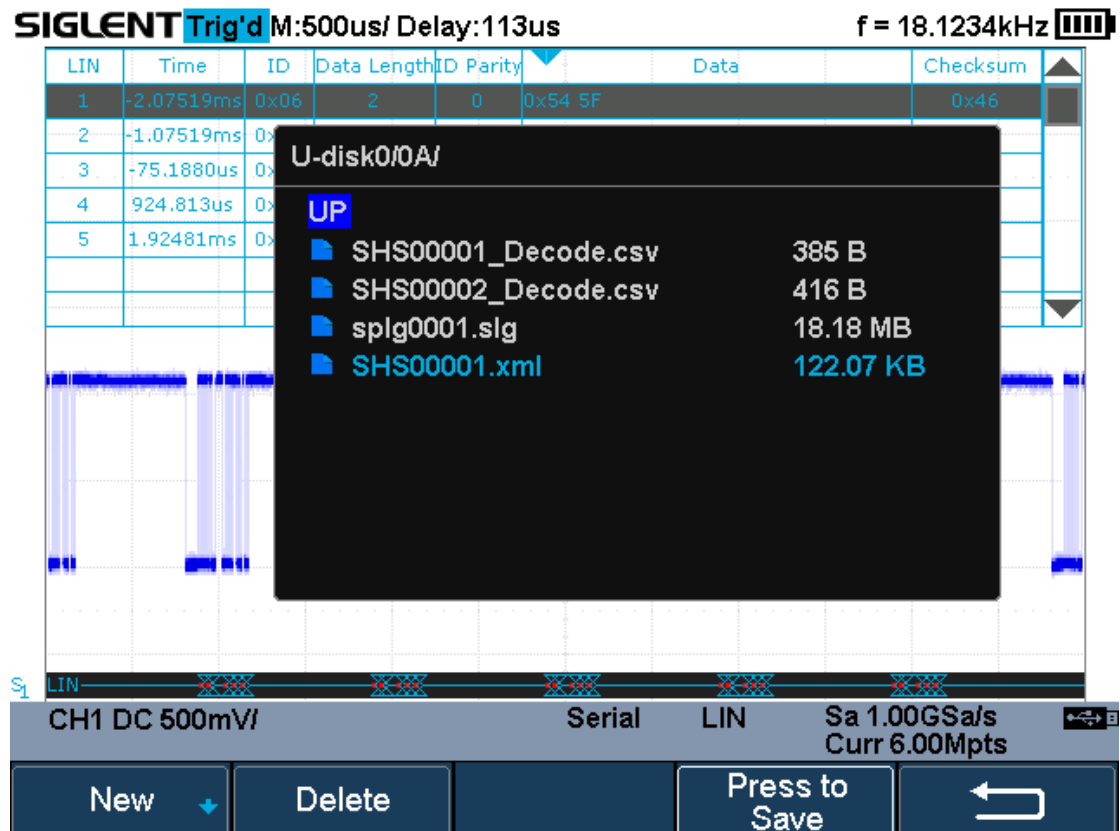

Figure 90 SAVE/RECALL File System

5. Use the **Universal Knob** to select the desired location. File can be stored under the root directory or in a certain folder under the root directory of the USB storage device.
6. After selecting the save position, press **New** softkey to turn on the interface, as shown in the figure below. Refer to the descriptions in “**To Create a new file or fold**” to create a new file name.

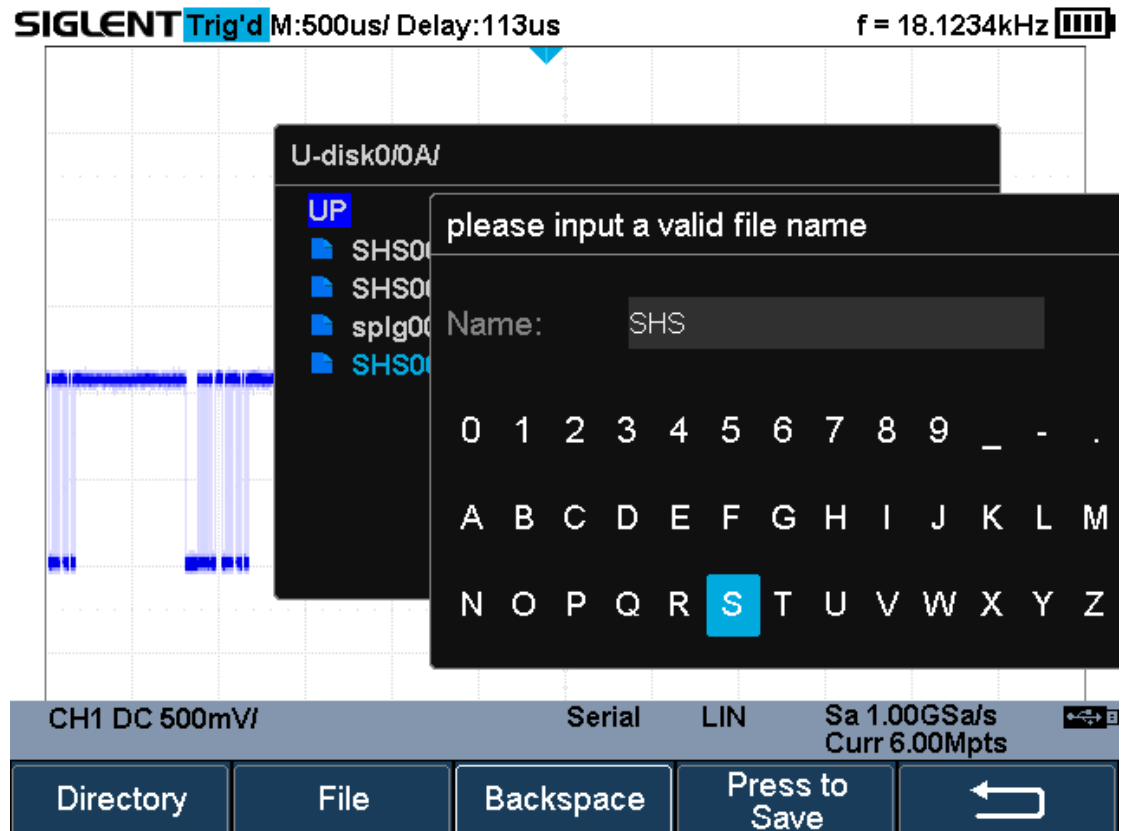

Figure 91 File Name Dialogue

7. Press the **Press to Save** softkey to save the current setup to the external USB storage device.
- **Load the specified type of file from the external USB storage device.**
1. Press the **Shift** and **Cursor** button on the front panel to enter the SAVE/RECALL function menu.
 2. Press the **Recall** softkey to enter the RECALL menu.
 3. Press the **Type** softkey to select **Setups** or **Reference**.
 4. Press the **Press to Recall** softkey to enter the disk manager.
 5. Turn the **Universal Knob** to select the file to be recalled, press the **Press to Recall** softkey to recall the reference waveform or setup.

Disk Management

Execute the following operations through the disk management menu:

- ◆ Create a New File or Folder
- ◆ Delete a File or Folder
- ◆ Rename a File or Folder

Create a New File or Folder

The oscilloscope supports English input method. The file name or folder name can contain letters, numbers, underscores and spaces. Let's use an example to introduce how to create a file or folder.

Example: create a file or folder named "SHS1000X_TEST"

1. Press the **Shift** and **Cursors** button on the front to enter the SAVE/RECALL function menu.
2. Press the **Save** softkey, and then turn the **Universal Knob** to select one of the type.
3. Press the **Press to Save** softkey to enter the SAVE/RECAL file system.
4. Press the **New** softkey to open the interface shown as the figure below. It divides into two parts: name input area and keyboard area.

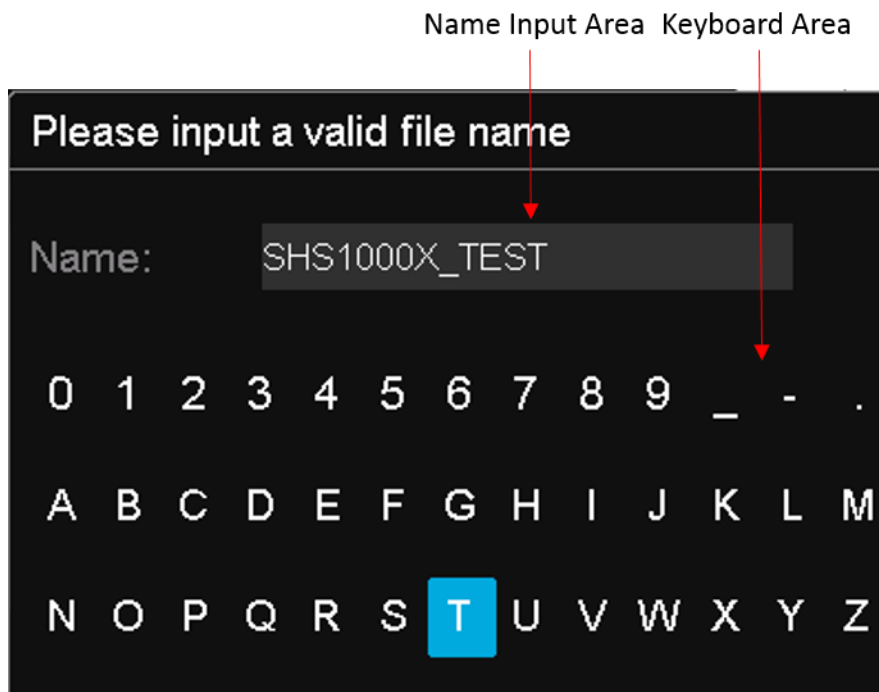

Figure 92 Input Keyboard

5. To delete the name in the name input area, press the **Backspace** softkey continuously to delete the character one by one.

Delete a File or Folder

1. Press the **Shift** and **Cursors** button on the front to enter the SAVE/RECALL function menu.
2. Press the **Save** softkey, and then turn the **Universal Knob** to select one of the type.
3. Press the **Press to Save** or **Press to Recall** softkey to enter the SAVE/RECAL file system.
4. Turn the **Universal Knob** to select the file or folder to be deleted, and then press the **Delete** softkey. Then the file or folder will be deleted.

Rename a File or Folder

Only files of the corresponding type format can be renamed.

1. Press the **Shift** and **Cursors** button on the front to enter the SAVE/RECALL function menu.
2. Press the **Save** softkey, and then turn the **Universal Knob** to select one of the type.
3. Press the **Press to Save** or **Press to Recall** softkey to enter the SAVE/RECAL file system.
4. Turn the **Universal Knob** to select the file or folder to be rename, and then press the **Rename** softkey. For details, see the instructions in "Create a New File or Folder."

System Setting

This function module supports the oscilloscope's system-related function, such as system status, language, sound, and other advanced settings, such as do self-cal, update and remote interface configure.

The contents of this chapter:

- ◆ View System Status
- ◆ Do Self Cal
- ◆ Quick-Cal
- ◆ Sound
- ◆ Language
- ◆ Update Firmware and configuration
- ◆ Do self-Test
- ◆ Screen Saver
- ◆ Date/Time
- ◆ Reference Position

View System Status

Do the following steps to view the system status:

1. Press the **Utility** button on the front to enter the UTILITY function menu.
2. Press the **System Status** softkey to view the system status of the oscilloscope.

The system status includes the information below:

- **Startup Times:** record the boot-strap times of the oscilloscope.
- **Software Version:** list the current software version of the oscilloscope.
- **Uboot-OS Version:** list the current Uboot and OS version of the oscilloscope
- **FPGA Version:** list the current fpga version of the oscilloscope.
- **Hardware Version:** list the current hardware version of the oscilloscope.
- **Product Type:** display the product type of the oscilloscope.
- **Serial No.:** list the serial number of the oscilloscope.

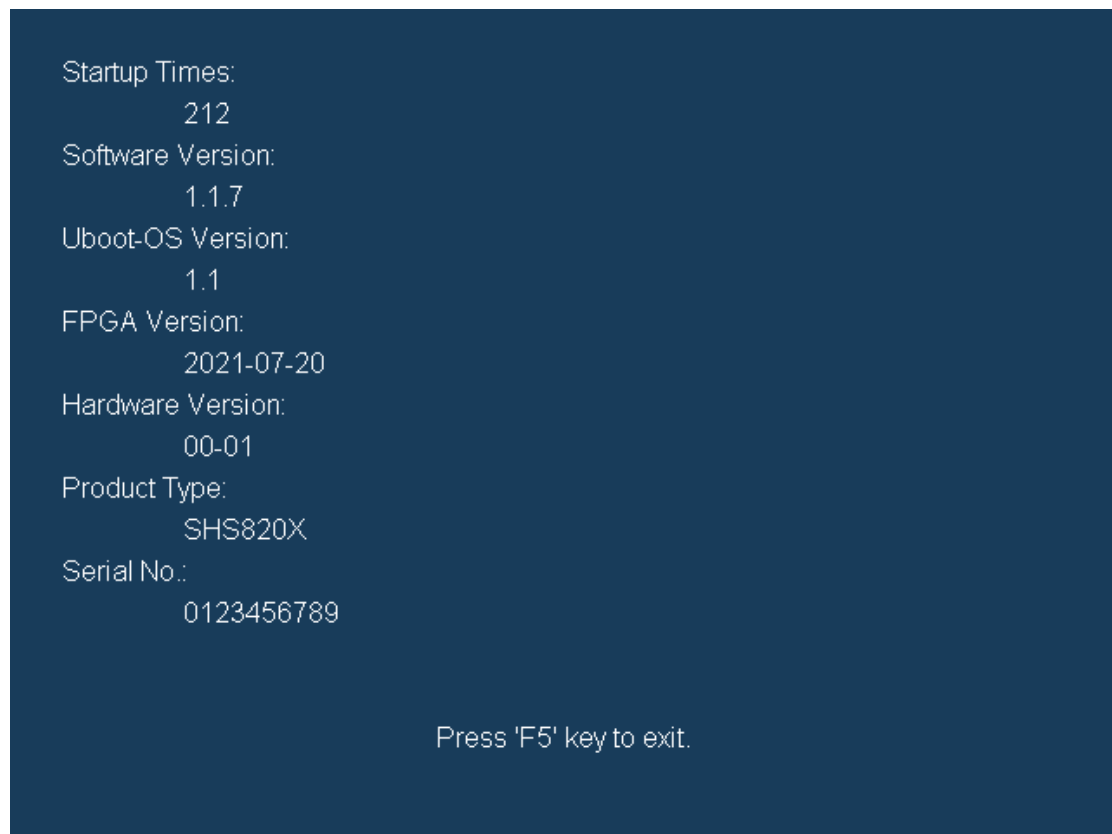

Figure 93 System Status

3. Press the **F5** button on the front panel to exit.

Do Self Cal

The self-calibration program can quickly make the oscilloscope reach the best working state to get the most precise measurement values. You can perform self-calibration at any time, especially when the environment temperature change is up to or more than 5 °C. Ensure that the oscilloscope has been warmed up or operated for more than 30 minutes before the self-calibration.

Do the following steps to do self-calibration:

1. Disconnect all the input channels.
2. Press the **Utility** button on the front panel, and then press the **Do Self Cal** softkey, and the oscilloscope will pop-out the message box shown as below:

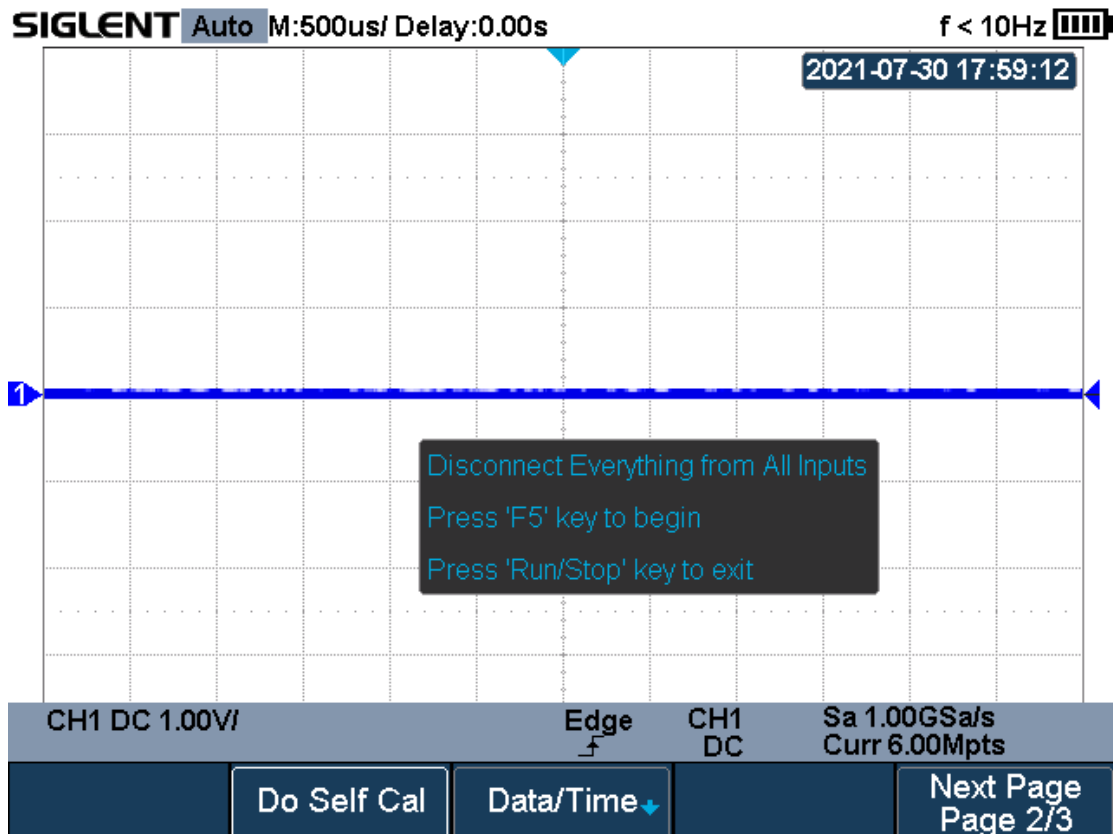

Figure 94 Do Self Cal

3. Press the **F5** button on the front panel to perform the self-calibration program. During the calibration, most of the keys are disabled.
4. When the self-calibration program is finished, it will pop-out the message "Press Run/Stop key to exit". Press the **Run/Stop** button on the front panel to exit the calibration interface.



Quick-Cal

Quick calibration can correct the measurement deviation caused by temperature to get more accurate measurements.

If the ambient temperature of your current operating oscilloscope is unstable, press **Utility** → **Quick-Cal** softkey to select **On** to enable quick calibration.

Sound

When the sound is enabled, you can hear the sound of the beeper when you press a function key or a menu softkey or when the prompt message pops up.

Press the **Utility** button on the front panel to enter the UTILITY function menu; then press **Sound** softkey to select  or  turn the sound on or off.

Language

The oscilloscope supports multiple language menu, Chinese/English help and prompt messages.

1. Press the **Utility** button on the front panel to enter the UTILITY Function menu.
2. Press the **Language** softkey; and then turn the **Universal Knob** to select the desired language. Then push down the knob to select the language.

The currently available languages are Simplified Chinese, Traditional Chinese, English, French, German, Spanish, Russian, Italian, and Portuguese.

Update Firmware and Configuration

The firmware and configuration can be updated directly via USB flash driver.

Do the following steps to update the firmware:

1. Insert the USB flash driver which with the firmware and the configure files inside into the USB host interface on the side panel of the oscilloscope.
2. Press the **Utility** button on the front panel to enter the UTILITY function menu.
3. Press the **Next Page** softkey to go to the third page of the UTILITY function menu.
4. Press the **Update** softkey to enter the UPDATE function menu.
5. Press the **Firmware** softkey to open the file manager.
6. Turn the **Universal Knob** to select the update file with an ADS postfix; and then press the **Press to Update** softkey to start updating the firmware. The process needs about 4 minutes. And during the update, do not remove power to the oscilloscope, otherwise the oscilloscope may be permanently damaged and may not restart again.
7. After the update, the screen will pop-out the message **“Firmware decompressed. Please restart and wait...”** .
8. Restart the oscilloscope to finish the firmware update.

Do the following steps to update the configuration:

1. Insert the USB flash driver which with the firmware and the configure files inside into the USB host interface on the side panel of the oscilloscope.
2. Press the **Utility** button on the front panel to enter the UTILITY function menu.
3. Press the **Next Page** softkey to go to the third page of the UTILITY function menu.
4. Press the **Update** softkey to enter the UPDATE function menu.
5. Press the **Configure** softkey to open the file manager.
6. Turn the **Universal Knob** to select the update file (*.CFG file extension) and then press the **Press to Update** softkey to start update the firmware. The process needs about 30 seconds.
7. After the update, the screen will pop-out the message **“Firmware decompressed. Please restart and wait...”**
8. Restart the oscilloscope to finish the configuration update.

Do Self-Test

Self-tests include screen test, keyboard test, and LED test. Self-tests used to test the screen, buttons, knobs and LED lights whether works well.

Screen Test

1. Press the **Utility** button on the front panel to enter the UTILITY function menu.
2. Press the **Next Page** softkey to go to the third page of the UTILITY function menu.
3. Press the **Do Self Test** softkey to enter the SELFTEST function menu.
4. Press the **Screen Test** softkey to enter the screen test interface, as the figure shown below, the screen display pure red.

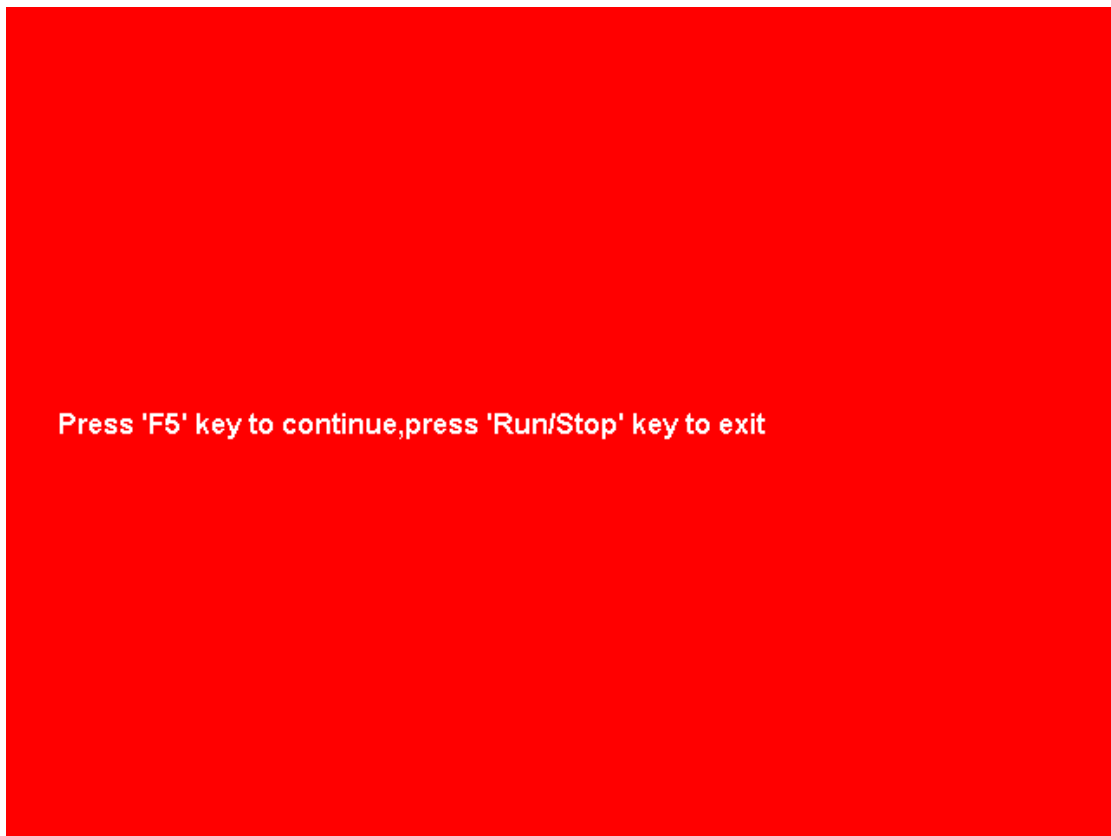

Figure 95 Screen Test

5. Press the **F5** button on the front panel continually as it says in the picture above. The screen displays green, blue and red again. It is easy to check chromatic aberration, stain and scratch of the screen under the condition.
6. Press the **Run/Stop** button on the front panel to exit the screen test program.

Keyboard Test

Keyboard test is used to test that if the keys or the knobs work well.
Do the following steps to do keyboard test:

1. Press the **Utility** button on the front panel to enter the UTILITY function menu.
2. Press the **Next Page** softkey to go to the third page of the UTILITY function menu.
3. Press the **Do Self Test** softkey to enter the SELFTEST function menu.
4. Press the **Keyboard Test** softkey to enter the keyboard test interface, as the picture shown below.

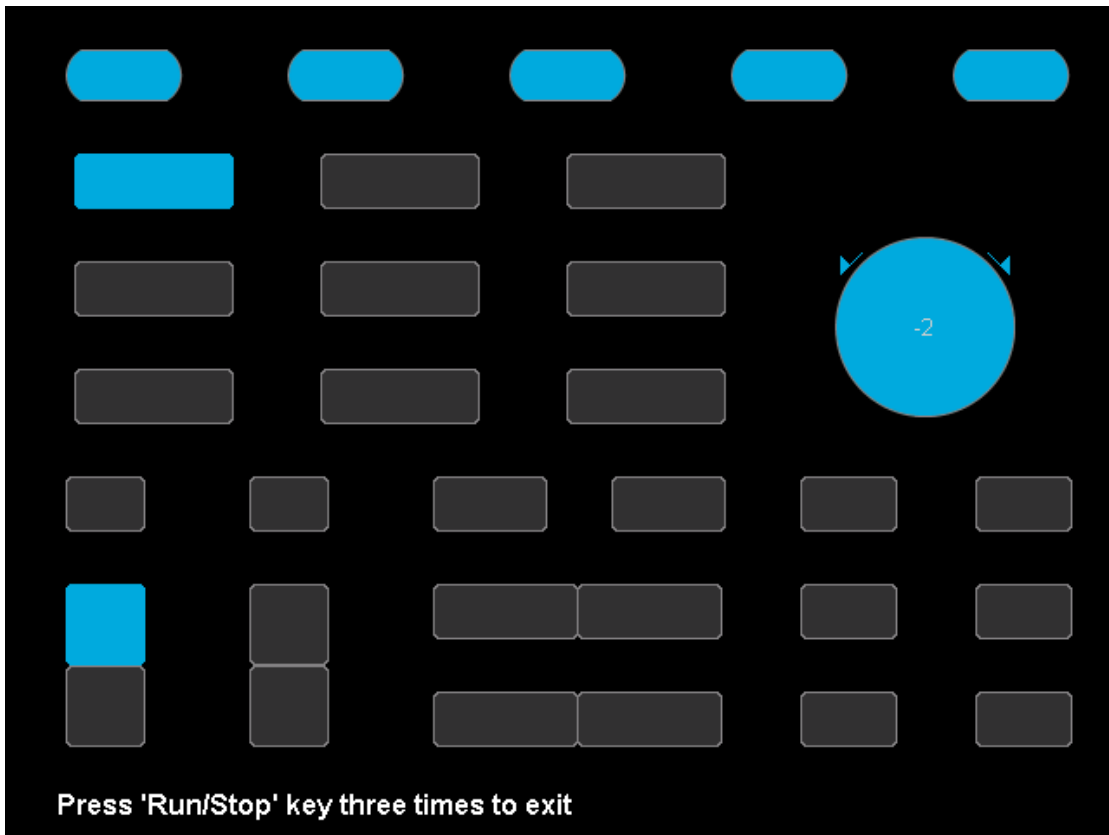

Figure 96 Keyboard Test

5. To perform the knobs and the buttons test.
6. Knobs test: the default value is 0. Turn left to increase the value while turn right to decrease; push the knob to set the value to 0.
7. Keys test: the first time pressing the key to light it up, and a second pressing to die out. Test every button randomly.
8. Press the **Run/Stop** button 3 times to exit the keyboard test program.

LED Test

LED test is used to test that if the button lights work well.

1. Press the **Utility** button on the front panel to enter the UTILITY function menu.
2. Press the **Next Page** softkey to go to the third page of the UTILITY function menu.
3. Press the **Do Self Test** softkey to enter the SELFTEST function menu.
4. Press the **LED Test** softkey to enter the keyboard test interface, as the picture shown below.

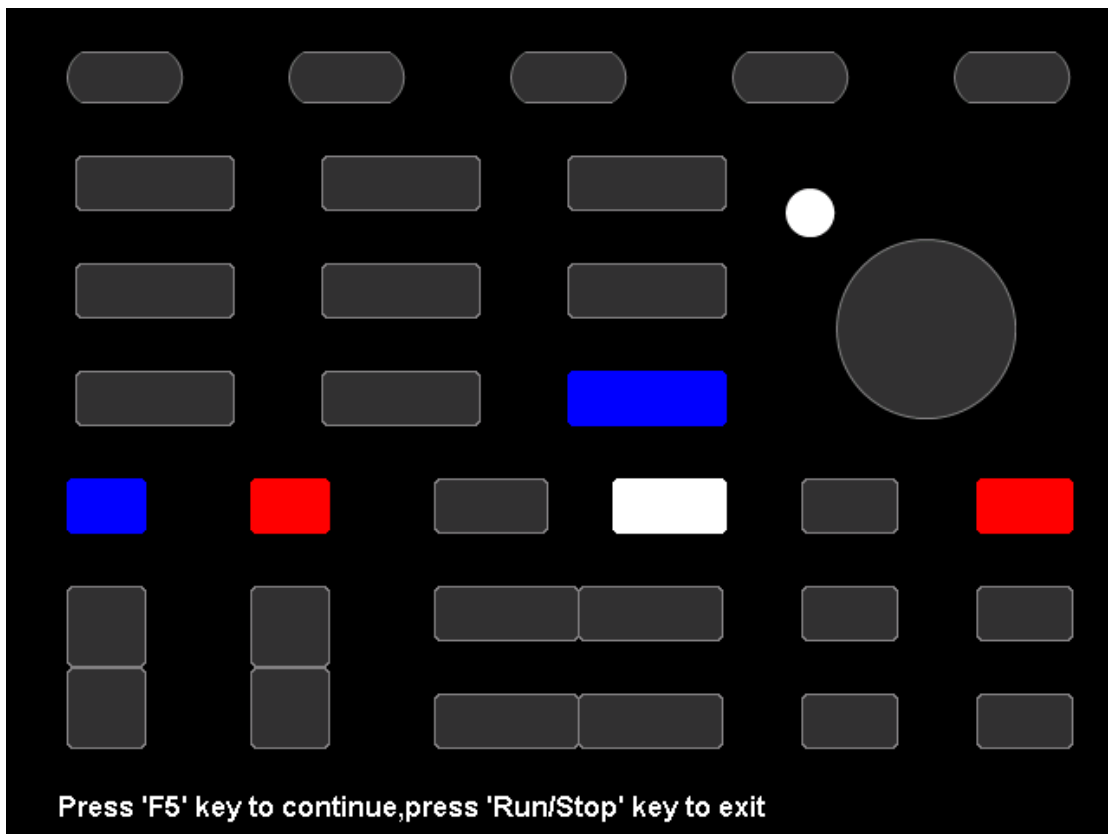

Figure 97 LED Test

5. According to the prompting information displaying on the screen, press the **F5** button continually to light the button lights one by one. The first time to light the **Run/Stop** button, it displays as yellow, and the second press the **Run/Stop** button displays as red. At last all the lights will be lighted at the same time.
6. Press the **Run/Stop** button to exit the LED test program.

Screen Saver

When the oscilloscope enters the idle state and holds for a certain period of time, the screen saver program will be enabled.

Do the following steps to set the screen saver time:

1. Press the **Utility** button on the front panel to enter the UTILITY function menu.
2. Press the **Next Page** softkey to go to the third page of the UTILITY function menu.
3. Press the **Screen Saver** softkey; and then turn the **Universal Knob** to select the desired screen saver time. The screen saver time can be set to **1min, 5min, 10min, 30min, and 1hour**. Also you can select **Off** to turn off the screen saver function

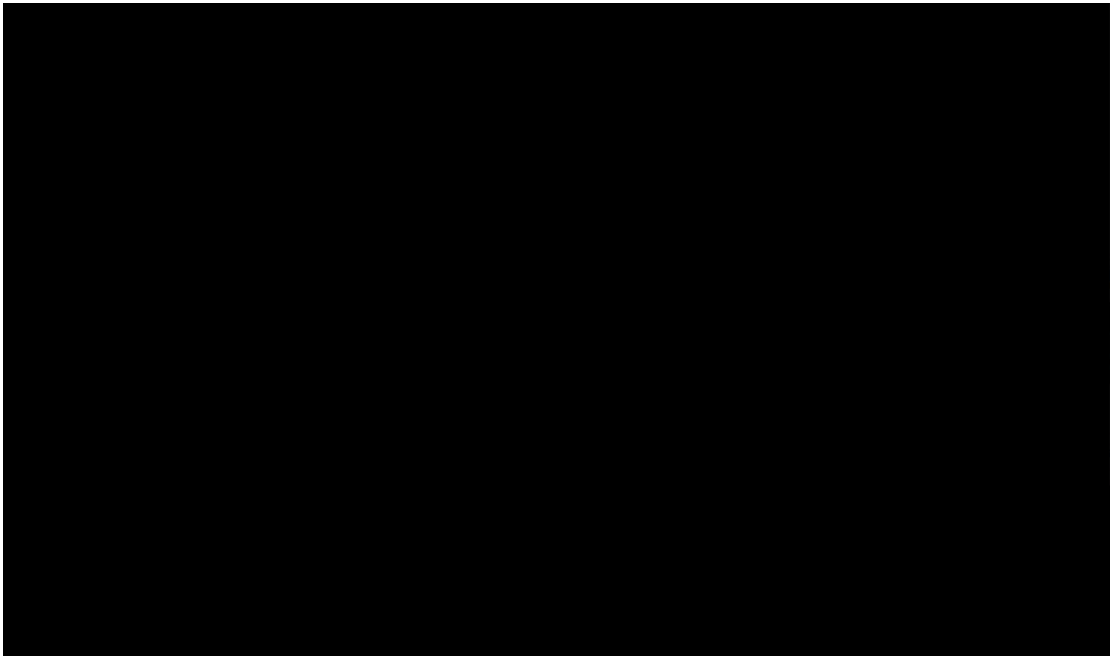

Figure 98 Screen Saver Interface

4. Press the any button on the front to exit the screen saver program.

Date/Time

SHS800X/SHS1000X supports setting date and time. After restarting the oscilloscope, you need to reset the system time.

- 1 Press **Utility** → **NextPage2/3** → **Date/Time** to enter the DATA/TIME function menu.
- 2 Press the **Display** softkey to select **On** to display the date and time.

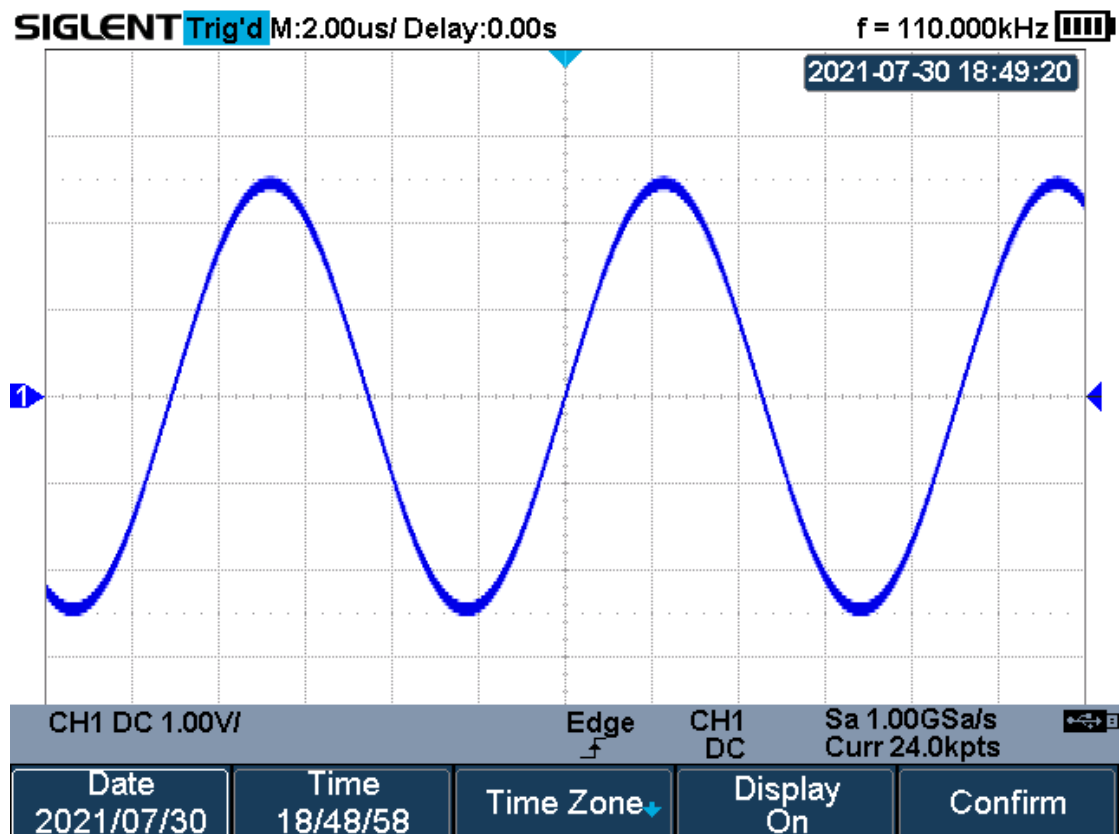

Figure 99 Date/Time Function Interface

Set Date/Time

Press the **Date/Time** softkey to enter the Data/Time setting menu. Press the **Date** softkey and press the **Universal Knob** to select year, month or day, then rotate the **Universal Knob** to change value. Modifying the time is similar to the date.

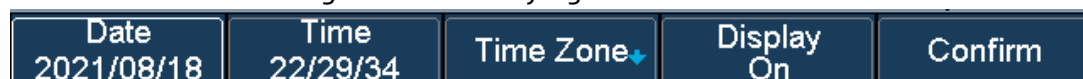

Figure 100 Setting Date/Time

Set Time Zone

- 1 Press the **Time Zone** softkey to enter the Time Zone function menu, and pop up time zone page.
- 2 Rotate the **Universal Knob** to select the time zone.
- 3 Press the **Confirm** softkey to confirm the selection.

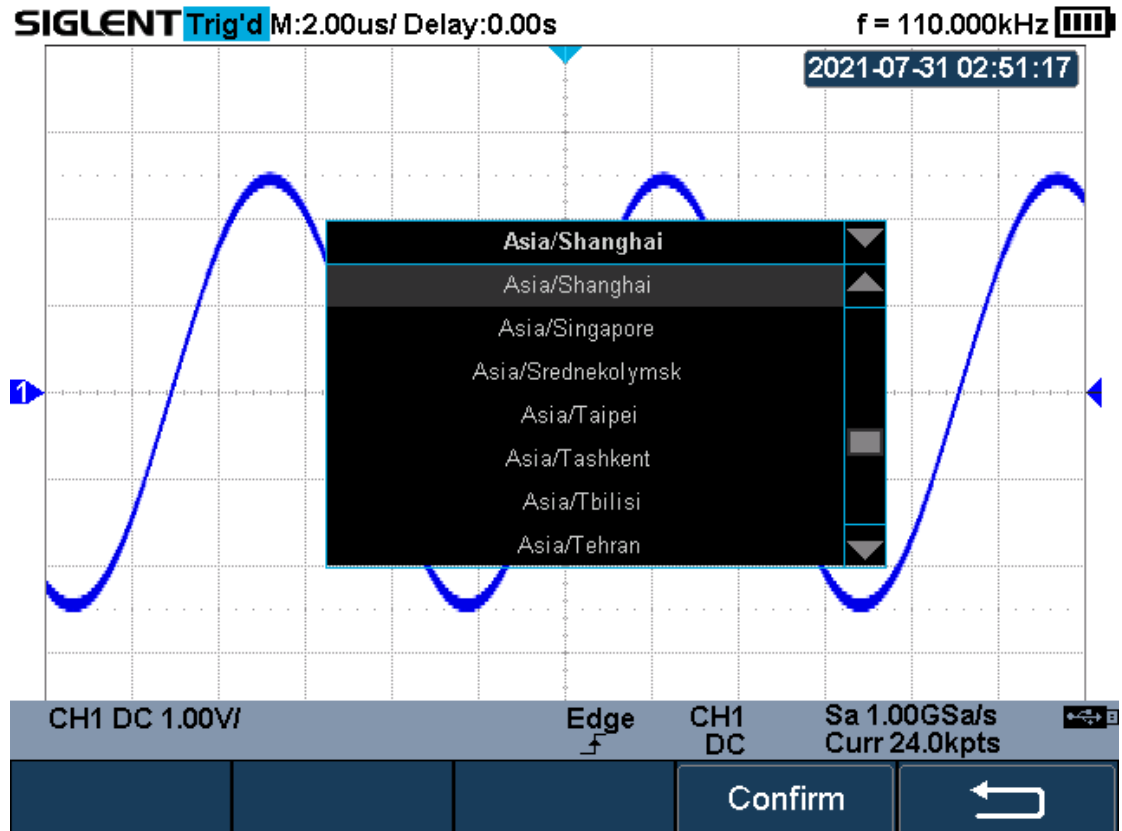

Figure 101 Time Zone Setting Interface

Reference Position

The reference position setting determines the physical point that the oscilloscope uses during vertical and horizontal scale changes. In some situations, it is more convenient to use a fixed position on the display.

Press the **Utility** button on the front panel and then press the **Reference Pos.** softkey to enter the Reference POS menu.

Press the **Vertical** softkey to select **Fixed Offset** or **Fixed Position**.

Fixed Position: The oscilloscope will keep the vertical offset level indicator stationary when the vertical gain is changed.

Fixed offset: The oscilloscope will have the vertical offset level indicator move with the actual voltage level when the vertical gain is changed.

Press the **Horizontal** softkey to select **Fixed Delay** or **Fixed Position**.

Fixed Position: when the timebase changes, the oscilloscope will keep the horizontal offset indicator stationary.

Fixed Delay: when the timebase changes, the oscilloscope will have the horizontal offset indicator move with the trigger point.

Search

SHS800X/SHS1000X provides search function. This function can search for the events that users specify in the acquired data, the results are displayed with black triangle symbol. In the YT mode or the Roll mode with the acquisition in stop, the maximum search events number is 600. In the Roll mode with acquisition in run, the maximum search events number is unlimited. The waveform can be zoomed when search function is enabled.

Setting

1. Press the **Shift** and **Scope** button on the front panel to enter the SEARCH function menu.
2. Press the **Mode** softkey and then use the **Universal Knob** to select the desired search type. SHS800X/SHS1000X provides five search types: Edge, Slope, Pulse, Interval and Runt.

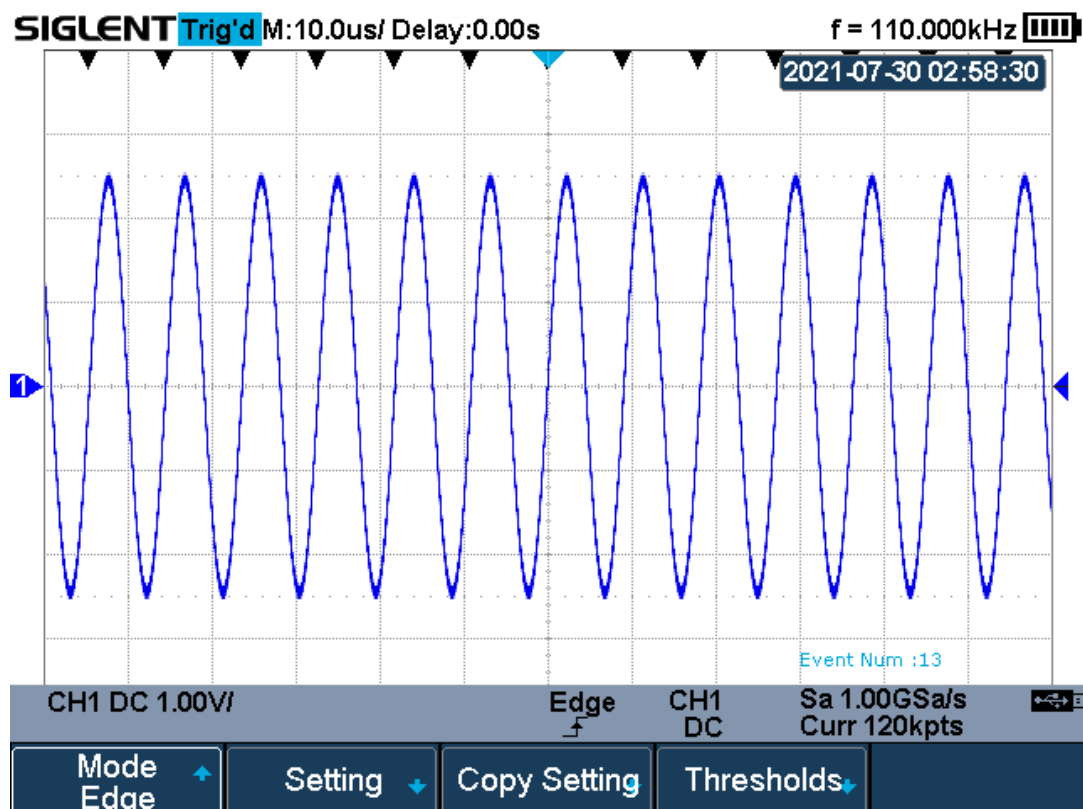

Figure 102 Search Menu

3. Press the **Setting** softkey to enter the SETTING function menu. The setting menu is different according to every search type. The details show as the following table.

Search Mode	Setting Menu Description
Edge	Slope includes Rising, Falling, Either.
Slope	Slope includes Rising, Falling Limit Range includes four types: \leq , \geq , [--,--] and --] [--, Users can select the desired type and then input the time value.
Pulse	Polarity includes Positive and Negative Limit Range includes four types: \leq , \geq , [--,--] and --] [--, Users can select the desired type and then input the time value.
Interval	Slope includes Rising, Falling Limit Range includes four types: \leq , \geq , [--,--] and --] [--, Users can select the desired type and then input the time value.
Runt	Polarity includes Positive and Negative Limit Range includes four types: \leq , \geq , [--,--] and --] [--, Users can select the desired type and then input the time value

4. Press the **Copy Setting** softkey to enter COPY function menu.
- **Copy from Trig:** copy the trigger setup for the selected search type to the search setup.
 - **Copy to Trig:** copy the setup for the selected search type to the same trigger type.
 - **Cancel Copy:** undo a copy.
5. Press the **Thresholds** softkey to enter THRESHOLDS function menu, then, to set channel search thresholds.

Results

When the acquisition is started, "EVENT NUM: 7" means total events number.

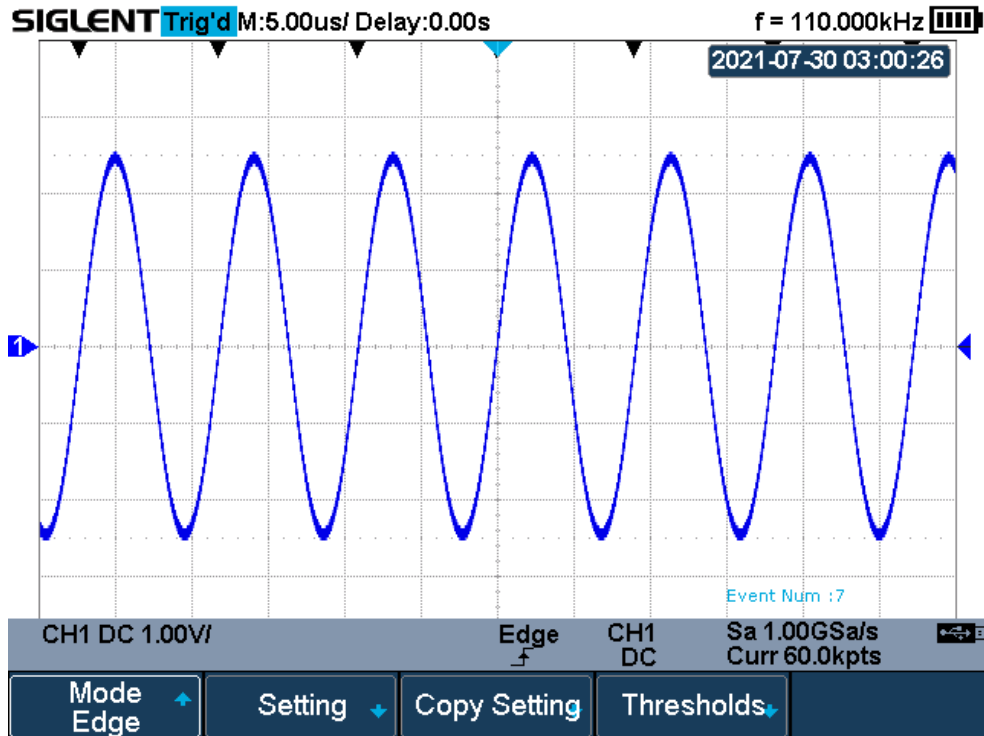

Figure 103 Search in Run

When the acquisition is stop, "EVENT NUM: 4/7" means current event number/total events number, the current event is the closest event to the middle of the screen.

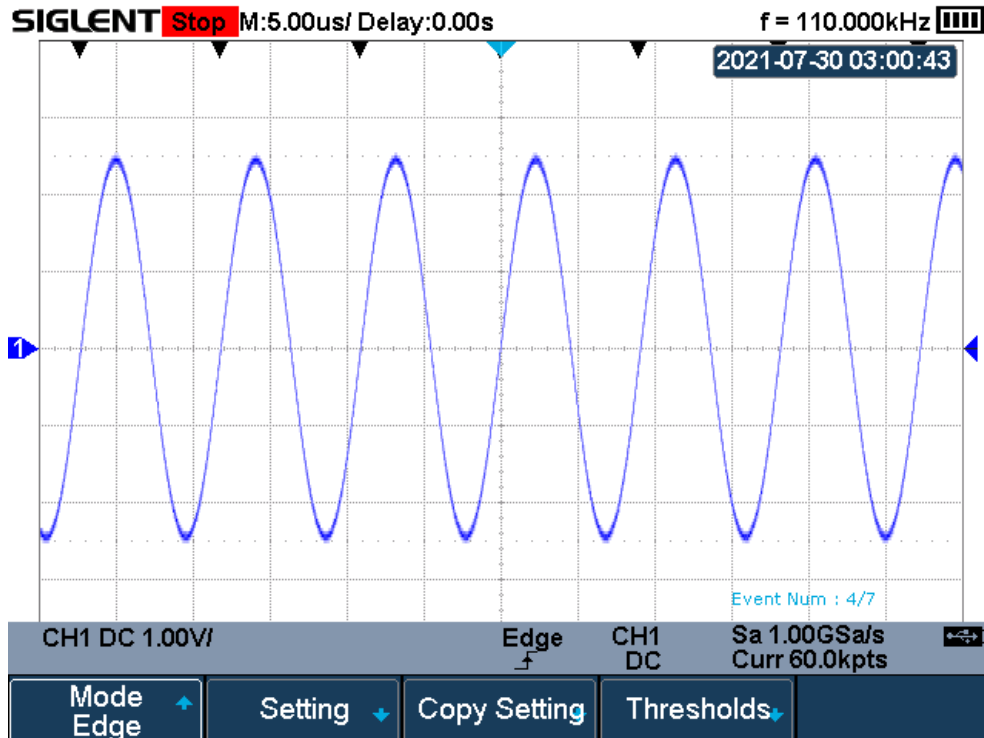







Figure 104 Search in Stop

Navigate



SHS800X/SHS1000X provides three navigate type: Search Event, Time, History Frame.

Time Navigate

1. Press the **Shift** and **Recorder** button on the front panel to enter the NAVIGATE function menu.
2. Press the **Type** softkey In the NAVIGATE function menu, then select **Time**.
3. There are two ways to navigate time.
 - a. Press the **Time** softkey, then, turn the **Universal Knob** to select the desired value or press the **Universal Knob** then enter the value by the pop keyboard.
 - b. Press the softkeys    to play backward, stop, or play forward in time. You can press the  or  key multiple times to speed up the playback. There are three speed levels: Low Speed, Medium Speed, and High Speed.



History Frame Navigate

You can use the navigation controls to play through the acquired frames when the History function is enabled.

1. Press the **Shift** and **Recorder** button on the front panel to enter the NAVIGATE function menu.
2. Press the **Type** softkey in the Navigate Menu, then select **History Frame**.
3. Press the **Frame Num** softkey, then there are two ways to navigate history frames.
 - a. Turn the **Universal Knob** to select the desired number or press the **Universal Knob** then enter the number by the pop keyboard.
 - b. Press the softkeys    to play backward, stop, or play forward.

Search Event Navigate

When the Search function is enabled and acquisitions are stopped, you can use the navigation controls to go to found search events

1. Press the **Shift** and **Recorder** button on the front panel to enter the NAVIGATE function menu.
2. Press the **Type** softkey in the NAVIGATE function menu, then select **Search Event**.
3. There are two ways to navigate search events.
 - a. Press the **Event Num** softkey, then, turn the **Universal Knob** to select the desired value or press the **Universal Knob** then enter the value by the pop keyboard.
 - b. Press the softkeys   to go to the previous or next search event.

History

The history function can record the waveforms of the input channels before press the **Run/Stop** button. In run state, the oscilloscope records input waveform continually; when fill up the memory (reach the maximal frame), the new frames will cover the old frames and keep the latest frames.

To use the History function, the HORIZONTAL **Format** must be set to YT.

Do the following steps to record and replay waveform:

- Press the **Shift** and **Meter** button on the front panel to enable the History function.
 - When in run state, the waveform will enter the stop state.
 - When in stop state, and then enable the History function, the oscilloscope will keep the stop state.
 - Press **Shift** and **Meter** button again to turn off History function.
- Press the **List** softkey to turn on or off the list display. The list records the timestamp of every frame. It is accurate to microseconds.

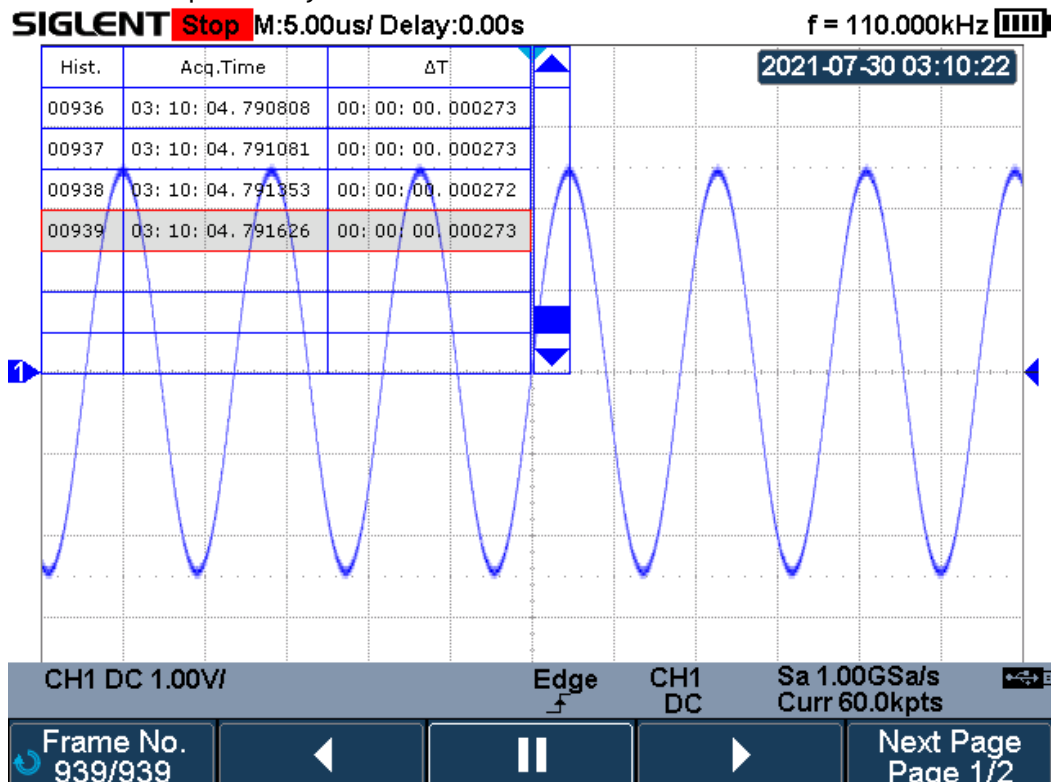





Figure 105 History

- Press the **Frame No.** softkey; then turn the **Universal Knob** to select the frame to display.

- The Frame format is A/B; A is the frames number that displays on the screen and B is the maximal frame number you can set.
 - The maximal frame number is determined by the current sampling point (**Curr** value) and sampling rate.
 - When press the **Run/Stop** button or enable the history function, you may not get the maximal frames, because the memory is not filled. So if you want to get the maximal frames, please wait for enough time for acquisition.
4. Press the  softkey to replay the waveform from the current frame to 1.
 5. Press the  softkey to stop replay.
 6. Press the  softkey to replay the waveform from the current frame to the last frame.

Meter

This chapter provides a step-by-step introduction to the multimeter functions of SHS800X/SHS1000X Handheld Digital Oscilloscope. The introduction gives basic examples to show how to use the menus and perform basic operations.

The digital multimeter provides the following measurements: DC voltage, AC voltage, resistance, diode, continuity, capacitance, DC current, and AC current.

Press the **Meter** button to enter the Meter function menu.



4 Reference: 1.001V

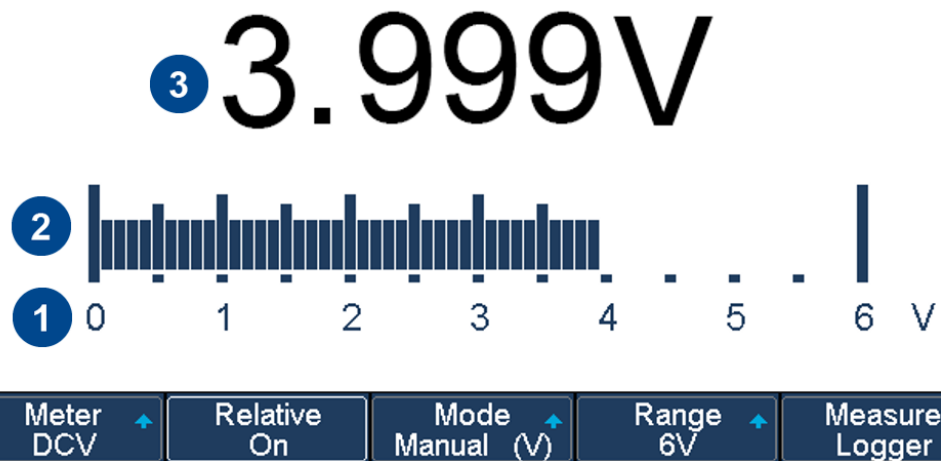

No.	Description	No.	Description
1	Range of the multimeter	4	Relative value
2	Bar graph displaying the measured value	5	Measurement type
3	Reading value	6	Measurement mode

DCV/ACV

The Multimeter enables to measure voltage according to the measurement catalog.

When applied in CATII, the maximum input voltage is 1000VDC/ 750VAC for the SHS1000X series. When applied in CATIII, the maximum input voltage is 600VDC/ VAC for the SHS1000X series.

When applied in CATII, the maximum input voltage is 600VDC/ VAC for the SHS800X series. When applied in CATIII, the maximum input voltage is 300VDC/ VAC for the SHS800X series.

The method to connect and measure DC/AC Voltage will be introduced in details as the following steps:

1. Press **Meter** to enter multimeter mode, press the **F1** softkey to choose **DCV**, **ACV** measurement.
2. Insert the red probe to the **V.Ω.C** banana jack input and the black probe to the **COM**. Connect the other end of probes to the power or load to be measured.
3. Activate or deactivates the **relative** measurement according to the real demand.
4. Choose **Manual** or **Auto** range according to the real demand. If you are in manual range mode, press the **F4** softkey to adjust the measurement range, or press the middle button of the universal knob to quickly switch the range.
5. Read voltage value.
6. Press the **Run/Stop** button to stop the meter measurement. The status "HOLD" is displayed on the upper left of the screen. Press the **Run/Stop** button again to continue the measurement.

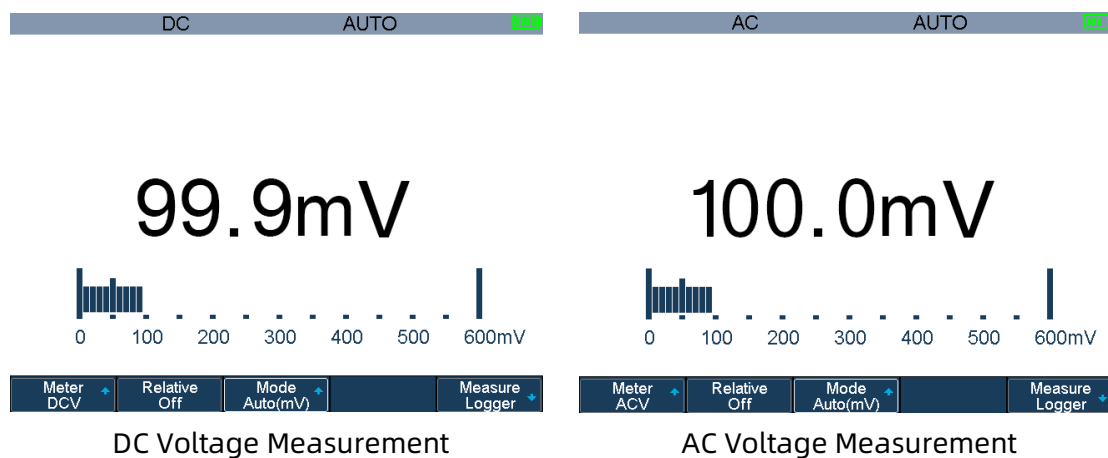

Table 3-1 DC and AC Function Menu

Option	Setting	Description
Relative	On	Save the current input value as a reference and record again. Real value equals relative value plus measurement value
	Off	Real value equals measurement value
Mode	Auto(V/mV)	Choose the best measurement scale automatically
	Manual(V/mV)	Choose measurement scale manually
Range	60mV 600mV	In manual mode, choose measurement scale manually and there will be a warning when over the scale.
	600mV 6V 60V 600V 1000V	
Measure Logger	On	Plot with the measurements according to time. See the "Measure Logger" section of the "Recorder" for the details.

Resistance

The method to test resistance will be introduced in details as the following steps.

1. Press **Meter** to enter multimeter mode, press the **F1** softkey to choose **Res.** measurement.
2. Insert the red probe to the **V.Ω.C** banana jack input and the black probe to the **COM**. Connect the other end of probes to the power or load to be measured.
3. Activate or deactivates the **relative** measurement according to the real demand.
4. Choose **Manual** or **Auto** range according to the real demand. If you are in manual range mode, press the **F4** softkey to adjust the measurement range, or press the middle button of the universal knob to quickly switch the range.
5. Read resistance value.
6. Press the **Run/Stop** button to stop the meter measurement. The status "HOLD" is displayed on the upper left of the screen. Press the **Run/Stop** button again to continue the measurement.

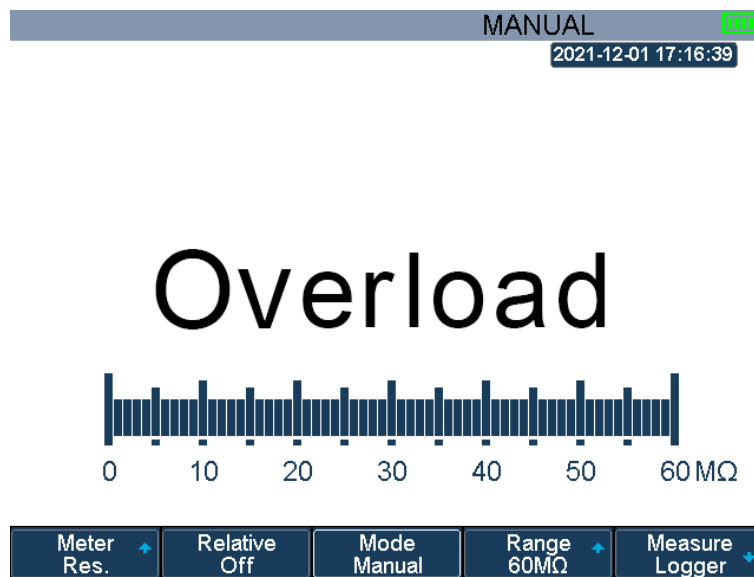

Figure 106 Resistance Measurement

Note: When measuring resistant, please make sure that the circuit is power off and the capacitance is discharged to avoid damage to the SHS800X/SHS1000X.

Diode

The method to test Diode will be introduced in details as the following steps.

1. Press **Meter** to enter multimeter mode, press the **F1** softkey to choose **Diode** measurement.
2. Insert the red probe to the **V.Ω.C** banana jack input and the black probe to the **COM**. Connect the other end of probes to the diode to be measured.

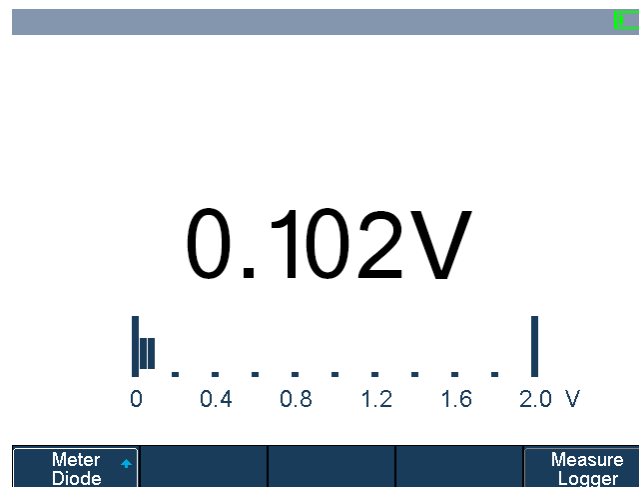

Figure 107 Diode Measurement

Continuity

Continuity test uses double leads method to measure the resistance of the measured circuit via about 0.2mA current. When the measured resistance in circuit is lower than the selected one, it is considered being connected with instrument.

The method to test continuity will be introduced in details as the following steps.

1. Press **Meter** to enter multimeter mode, press the **F1** softkey to choose **Continuity** measurement.
2. Insert the red probe to the **V.Ω.C** banana jack input and the black probe to the **COM**. Connect the other end of probes to the object to be measured.
3. When the measured object is under 50Ω, the multimeter will alarm and read value.
4. When the measured object is above 50Ω, the multimeter will not alarm but read value.

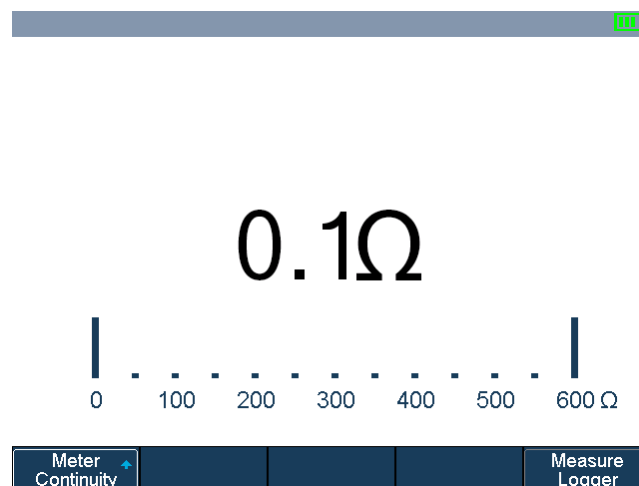

Figure 108 Continuity Measurement

Capacitance

The Multimeter enables to measure Capacitance up to 400 μ F. The method to measure capacitance will be introduced in details as the following steps.

1. Press **Meter** to enter multimeter mode, press the **F1** softkey to choose **Cap.** measurement.
2. Insert the red probe to the **V. Ω .C** banana jack input and the black probe to the **COM**. Connect the other end of probes to the measured object.
3. Activate or deactivates the **relative** measurement according to the real demand.
4. Read measurement value.

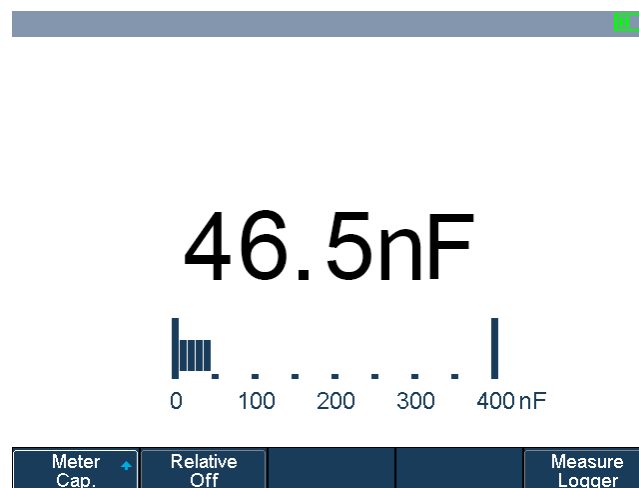

Figure 109 Capacitance Measurement

DCI/ACI

The Multimeter enables to measure DC/AC Current up to 10A by using the accessory SCD10A. The Multimeter enables to measure DC/AC Current up to 600mA by using the accessory SCD600MA .

When using the above two accessories, the voltage of the measured circuit shall not exceed 60VDC/ VAC.

SCD10A



SCD600MA



The method to measure DC/AC Current will be introduced in details as the following steps.

1. Press **Meter** to enter multimeter mode, press the **F1** softkey to choose **DCI/ACI** measurement.
2. Insert the SCD10A/SCD600MA to the Multimeter inputs.
3. Insert the red probe to the "+" banana jack input and the black probe to the "-" banana jack input. Connect the other end of probes to the power or load to be measured in series.
4. Activate or deactivates the **relative** measurement according to the real demand.
5. Choose **Manual** or **Auto** range according to the real demand. If you are in manual range mode, press the **F4** softkey to adjust the measurement range, or press the middle button of the universal knob to quickly switch the range.
6. Read current value.
7. Press the **Run/Stop** button to stop the meter measurement. The status

“HOLD” is displayed on the upper left of the screen. Press the **Run/Stop** button again to continue the measurement.

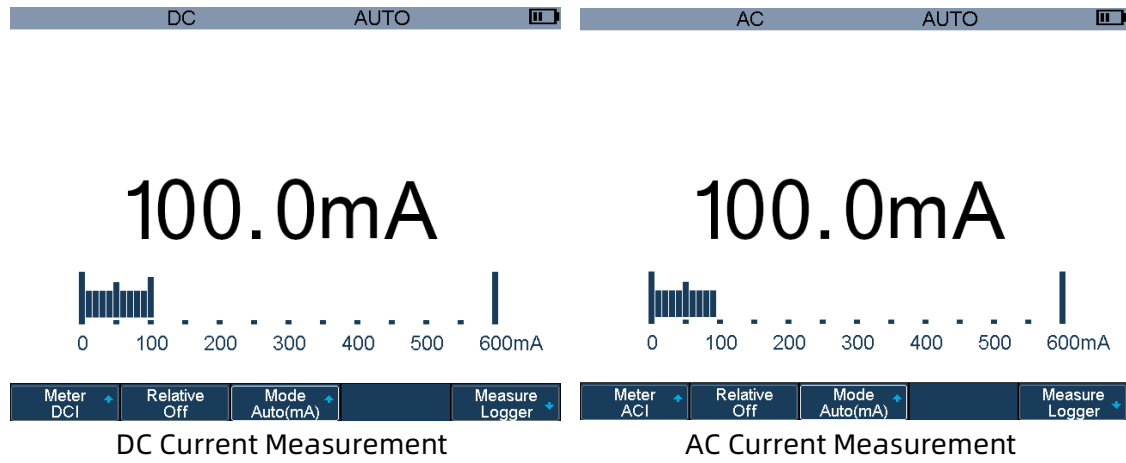

Recorder

SHS800X/SHS1000X supports Sample logger and Measure logger, which can record waveform data and measurement value.

Press the **Recorder** button to enter the RECORDER function menu.



Figure 110 Recorder Menu

Sample Logger

The Sample logger can record the original waveform points in real time at equal intervals to realize the long-time observation of low-speed signals. The recorded data can be stored in the internal or external storage device in real time. After stopping recording, users can replay the waveform on the oscilloscope, also can export the recorded data and then analyze on the PC.

Press the **Sample Logger** softkey to enter the sample logger interface. At this time, all the buttons on the front panel will not respond (except for the menu softkey, **Meter**, **Scope**, **Hide Menu** and **Universal Knob**). Press the **Exit** softkey to exit the sample logger.

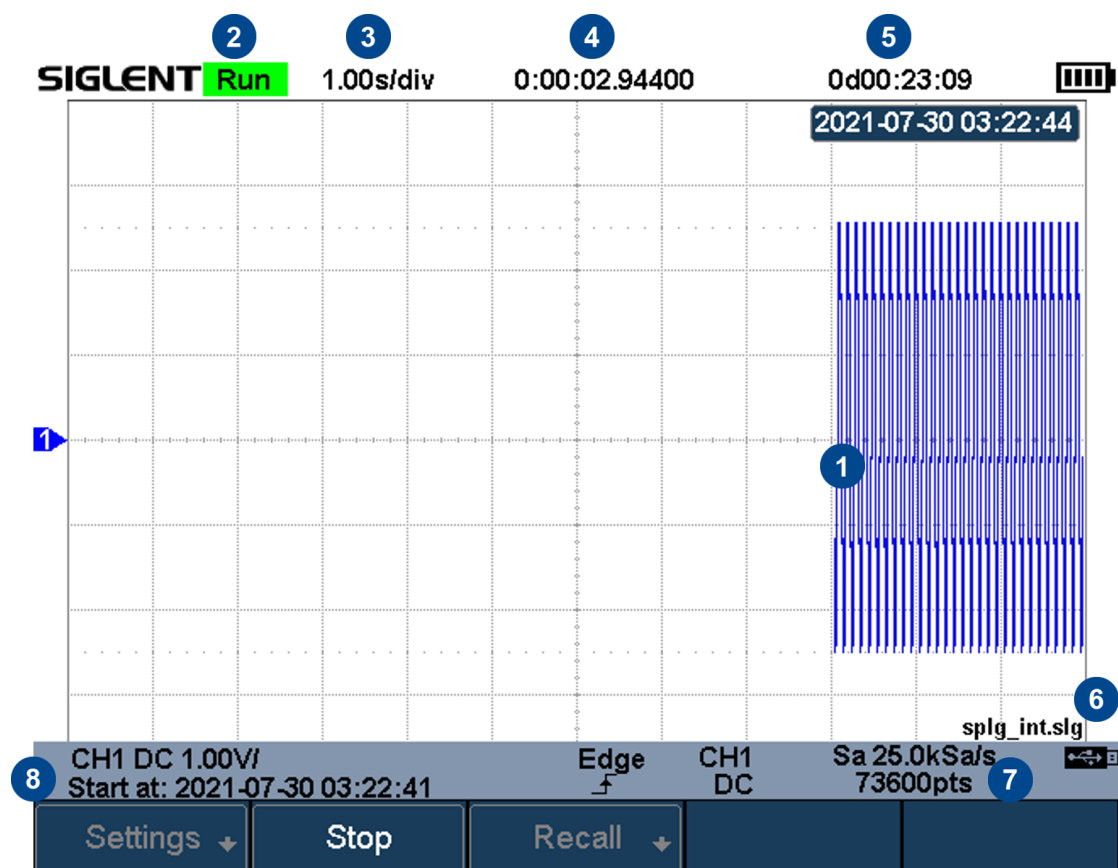

Figure 111 Sample Logger Interface

No.	Description
1	Recorded waveform
2	Record status (Run/Stop)
3	Horizontal scale
4	Recorded time
5	Remaining recordable time
6	Storage location
7	Sample rate and recorded points of waveform
8	Start time

Record Waveform

- 1 Press the **Record** softkey to enter the RECORD function menu.
- 2 Press the **Setting** softkey to enter the SETTINGS function menu. Press the **Rate** softkey to set the sampling rate of the waveform. Press the **Record to** softkey to set the storage location of the recorded data:
 - **Internal:** Record the data to internal, the last recorded internal data will be overwritten. Please confirm the operation when start to record.
 - **External:** Record the data to external storage device, and set the external

storage path.



Figure 112 Settings Interface

- 3 Press the **Return** softkey to return to the RECORD function menu.
- 4 Press the **Start** softkey to start to record, and the record status in the top information bar is displayed as "Run".

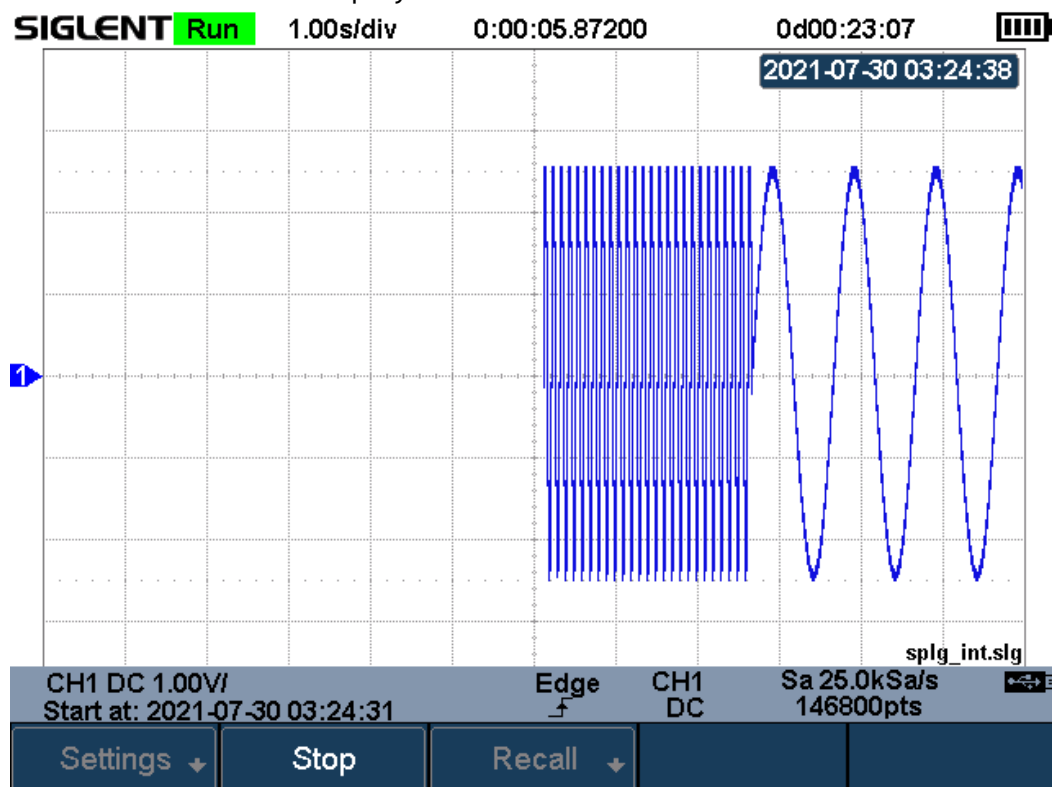

Figure 113 Start Recording Waveform

- 5 Press the **Stop** softkey to stop recording, and the record status in the top information bar is displayed as "Stop", the data is automatically stored in the storage location.
- 6 Press the **Recall** softkey to look back and analyze the waveform.

Note: When recording to external, the waveform data will be stored to the external in real time. Please do not pull out the U disk during the recording process!

Recall Recorded Waveform

- 1 Press the **Recall** softkey to enter the RECALL function menu.

- 2 Press the **Recall from** softkey to select the storage path.
- 3 Press the **Press to Recall** softkey to recall the recorded waveform data and enter the CONTROL menu automatically.

Display Control

- 1 Press the **Horizontal Ref** softkey to set the horizontal reference position.
- 2 Press the **Horizontal Scale** button to zoom the waveform with the horizontal reference as the center. Press the **Horizontal Position** button to move the waveform.
- 3 Press the **View all** softkey to return to the initial configuration to view all waveforms.
- 4 After recalling the waveform, press the **Cursors** button to turn on the cursor function to measure and analyze the waveform on the screen. Please refer to the chapter "错误!未找到引用源。" for operation.

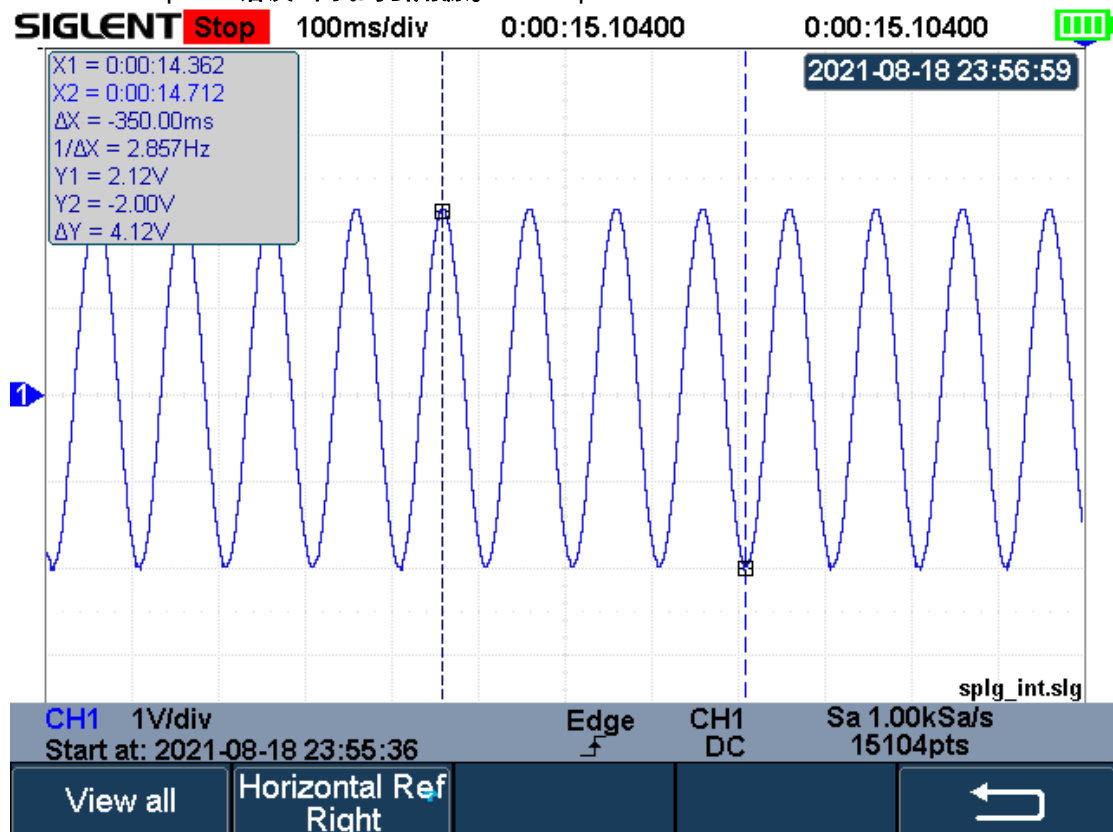

Figure 114 View Recorded Waveform

Manage Internal Record

- 1 Press the **Manage** softkey to enter the MANAGE function menu.
- 2 Press the **Export Internal Data** softkey to export the internal record to the

external storage device. See the chapter "Save and Recall" for operation. The file format (*.slg) is described in detail in the document "How to Extract Data from the Binary File.docx". Please download from SIGLENT website. The oscilloscope provides a tool named fileconverter to convert the waveform file (*.slg) to CSV format. You can download it from the Save/Recall menu.

- 3 Press the **Delete Internal Data** softkey to delete the internal record.

Measure Logger

The Measure logger can record the measured value of waveform in real time to realize the long-time measurement trend observation of low-speed signal. The measurement data is recorded in the internal, and can be stored to the internal or external storage device after stopping recording. It can support up to 4 traces of data at the same time.

Turn on the measure function under the scope interface, add measurement items, then press **Recorder** → **Measured Logger** to turn on the measure logger; Press the **Exit** softkey to exit the measure logger.

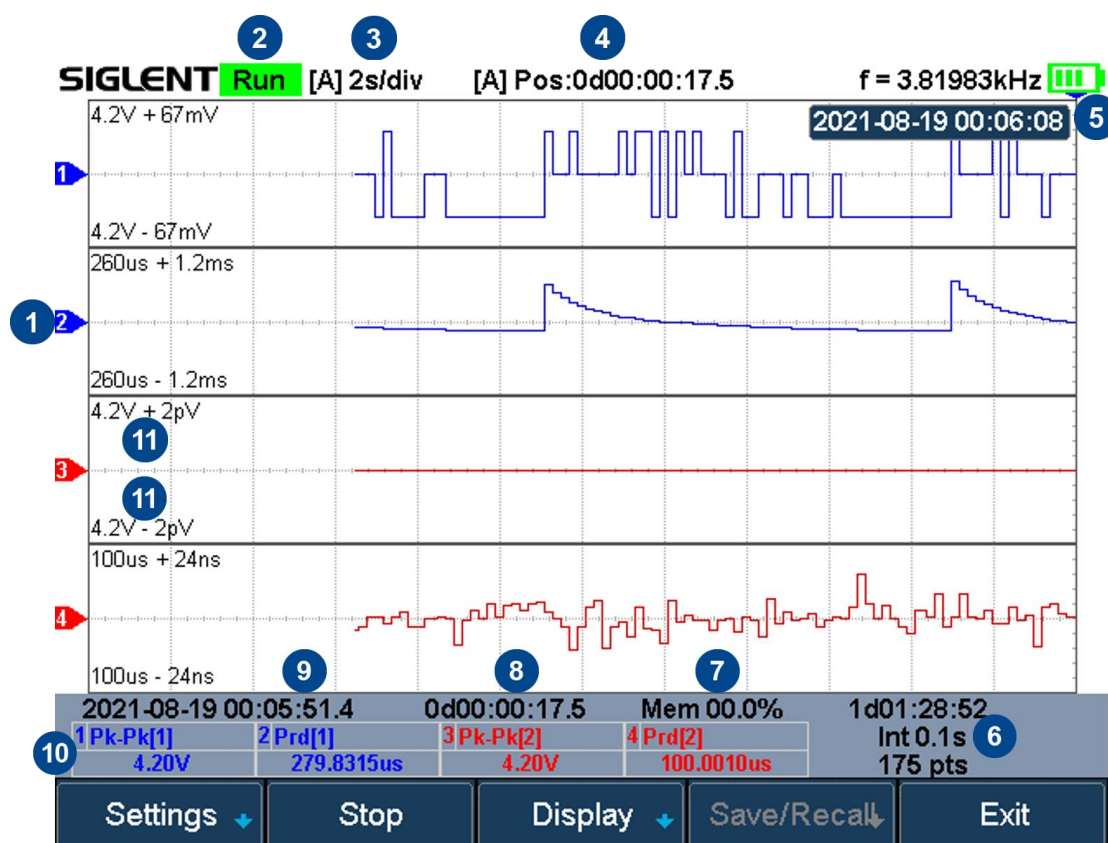

Figure 115 Measure Logger Interface

No.	Description
1	Record trace
2	Record status (Run/Stop)
3	[Auto/Manual] Horizontal scale
4	[Auto/Manual] Time value of the first point (centered on horizontal reference position)

5	Horizontal reference position
6	Remaining recordable time, Recording interval, Number of recorded points
7	Used memory
8	Recorded time
9	Start time
10	The current value of measurement items
11	Upper and lower scale of the trace

Start/Stop Recording

- 1 Press the **Setting** softkey to enter the SETTINGS function menu. Set record interval, record trace and the corresponding measurement item.



Figure 116 Settings Interface

- 2 After setting, press the **Return** softkey to return to the previous menu.
- 3 Press the **Start** softkey to start to record, the record status in the top information bar is displayed as "Run". During the recording process, the measure logger automatically adjusts the horizontal scale to show the trace. Users also can turn the **Horizontal Scale/Position** button to enter the manual mode to zoom and move the recording trace.

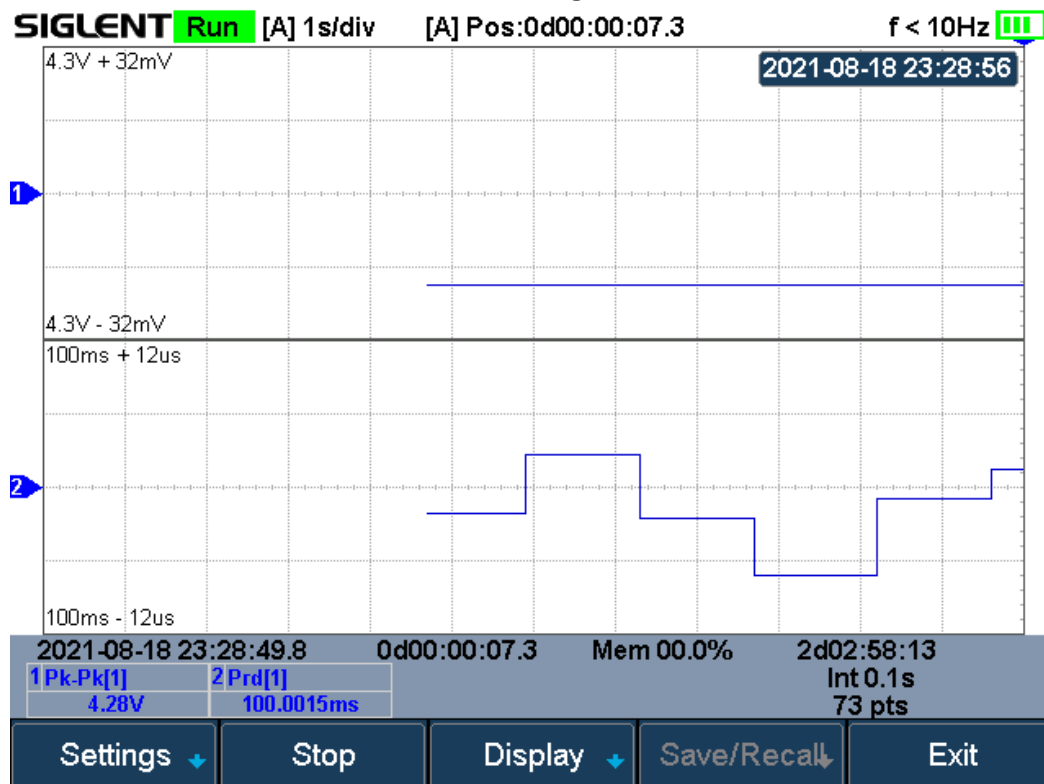

Figure 117 Start to Record Measurement Data

- 4 Press the **Stop** softkey to stop recording, the record status in the top information bar is displayed as "Stop".

Display Control

- 1 Press the **Display** softkey to enter the DISPLAY settings menu.



- 2 Press the **Vertical Scale** softkey and turn the **Universal Knob** to set the vertical scale of the trace. Users can also adjust the scale through the vertical scale button of the channel (**mV** or **V**) on the front panel.
- 3 Press the **Horizontal** softkey to enter the horizontal display settings menu. Users can zoom and move the logger trace and set the horizontal reference position. Press the **Auto Set** softkey to recover the default state.
- 4 Press the **Display** softkey and select **All**, all traces are displayed in the waveform area. When a trace is selected, only the selected trace is displayed in the waveform area. Press the channel button corresponding to the trace to switch all/individual display.

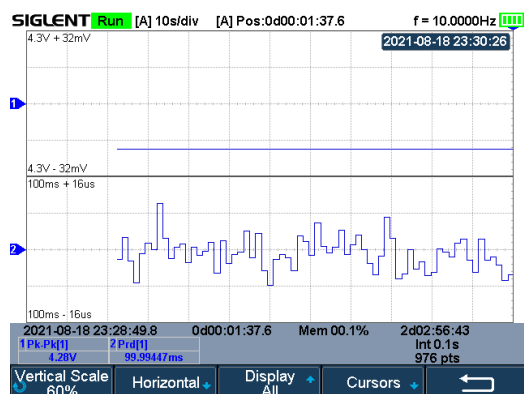

All Traces Display

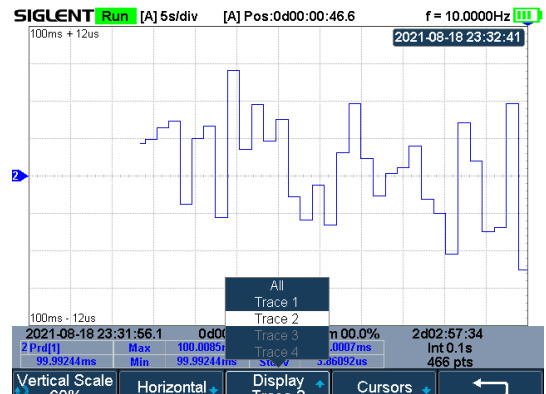

Single Trace Display

- 5 Press the **Cursors** softkey to enter the cursors function menu. Move the cursor to obtain the measured value of each point.
 - a. Press the **Status** softkey and select **ON** to turn on the function. Users also can press the **Cursors** button to turn on it.
 - b. Press the **Select** softkey to select the cursor **T1**, **T2** or **T1-T2**.
 - c. Press the **Strategy** softkey to choose the behavior of cursors when horizontal scale or position is changed.
 - **Fixed Position**: cursors remain fixed to the grid position on the display
 - **Fixed Time**: the value of cursors remain fixed.
 - d. Press the **Track Mode** softkey to select the track mode of T-Cursors.
 - **Normal**: Track the data at the time of T-Cursors
 - **Maximum**: Track the maximum value of the data within a pixel where T-Cursors are located.

- **Average:** Track the average value of the data within a pixel where T-Cursors are located.
- **Minimum:** Track the minimum value of the data within a pixel where T-Cursors are located.
- **Peak:** Track the data with the maximum deviation from the overall average value in a pixel where T-Cursors are located. When two cursors are at the same position, T1 will track the maximum value and T2 will track the minimum value.

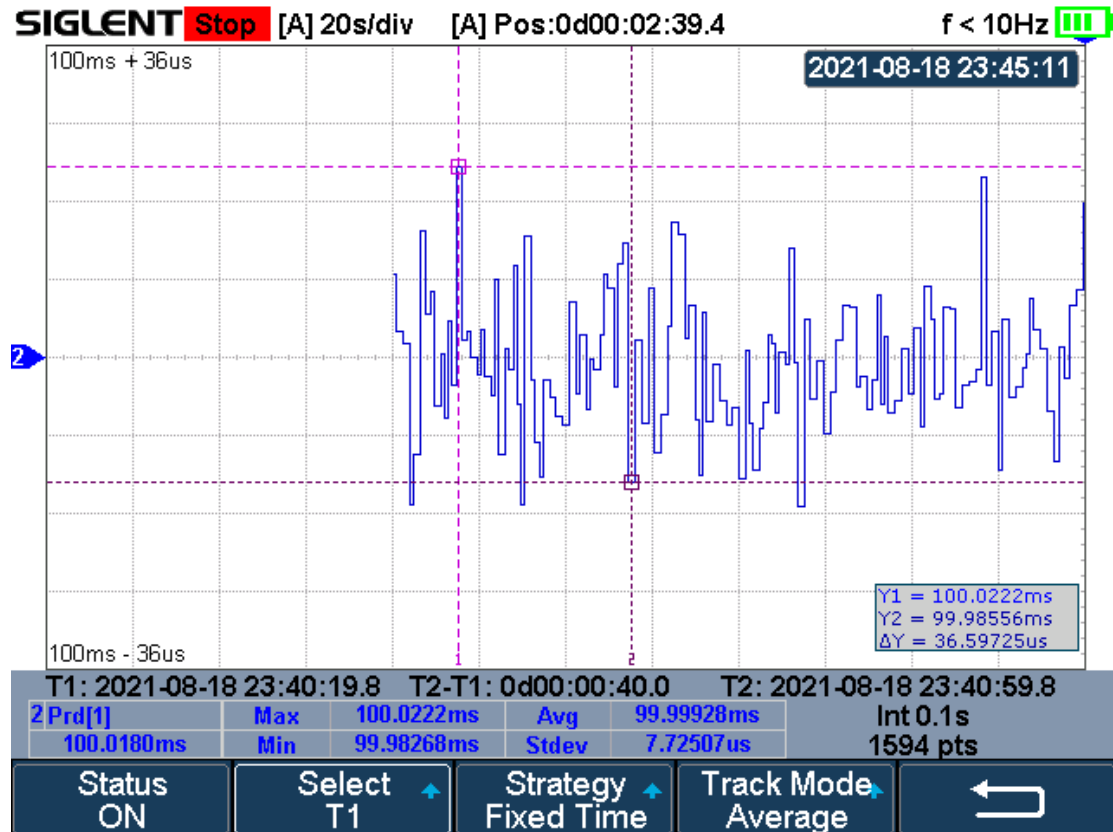

Figure 118 Cursors of Measure Logger

Storage Measurement Record

- 1 Press the **Save/Recall** softkey to enter the SAVE/RECALL function menu.

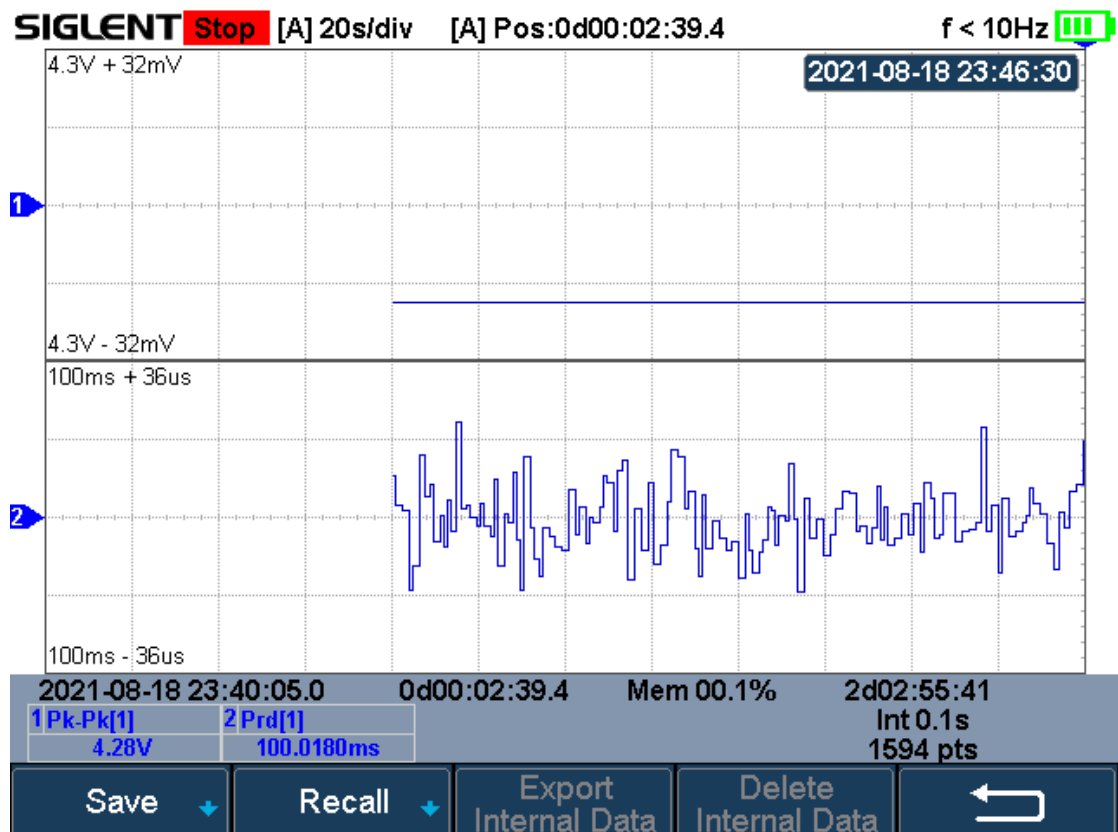

Figure 119 Save/Recall of Measure Logger

- 2 Press the **Save** softkey to enter the SAVE menu.



Figure 120 Save of Measure Logger

- 3 Press the **Save to** softkey to select where to store.
- **Internal:** The measurement data will be saved in binary data format, and the last data stored internally will be overwritten.
 - **External:** The measurement data can be saved as binary data(*.mlg), CSV data or MATLAB data
- 4 Press the **Press to Save** softkey to save.

Recall Measurement Record

- 1 Press **Save/Recall** → **Recall** to enter the RECALL function menu.
- 2 Press the **Recall from** softkey to select where to recall. Only binary files can be recalled from internal; while binary files or MATLAB files can be recalled from external. If the current data is not saved, it will be covered by the recalled the data.
- 3 Press the **Press to Recall** softkey to recall.

Manage Internal Record

Export or delete the internal record, it is similar to "**Manage Internal Record**" of Sample Logger.

Factory Setup

Press **Shift** and **Save/Recall** button to enter the save/recall function menu, then press **Save** menu select **To Default Key** and save the type to **Factory Setup**. Then press the **Default** button on the front panel to set the oscilloscope to the leave factory setup. Another way is press **Shift** and **Save/Recall** button, then press **Recall** menu select **Factory Default** to recall.

Troubleshooting

The commonly encountered failures and their solutions are listed below. When you encounter those problems, please solve them following the corresponding steps. If the problem remains still, please contact **SIGLENT** Company as soon as possible.

1. **The screen is still dark (no display) after power on:**
 - 1) Check whether the power is correctly connected.
 - 2) Check whether the power switch is really on.
 - 3) Check whether the fuse is burned out. If the fuse needs to be changed, please use the specified fuse.
 - 4) Restart the instrument after finishing the above inspections.
 - 5) If it still does not work correctly, please contact **SIGLENT**.

2. **The signal is sampled but no waveform of the signal is displayed:**
 - 1) Check whether the probe is correctly connected to the signal connecting wire.
 - 2) Check whether the signal connecting wire is correctly connected to the BNC (namely channel connector).
 - 3) Check whether the probe is correctly connected to the item to be tested.
 - 4) Check whether there are signals generated from the item to be tested (you can connect the probe compensation signal to the problematic channel to determine which has problem, the channel or the item to be tested).
 - 5) Resample the signal.

3. **The tested voltage amplitude is greater or lower than the actual value (note that this problem usually occurs when probe is used):**

Check whether the attenuation coefficient of the channel complies with the attenuation ratio of the probe.

4. **There is waveform display but not stable:**
 - 1) Check the trigger signal source: check whether the **Source** item at the trigger panel complies with the signal channel actually used.
 - 2) Check the trigger type: general signals should use “Edge” trigger and video signal should use “Video” trigger. Only when the proper trigger type is used, can the waveform be displayed stably.
 - 3) Change the trigger holdoff setting.

5. **No display after pressing Run/Stop:**

Check whether the mode at the trigger panel (TRIGGER) is on “Normal” or

“Single” and whether the trigger level exceeds the waveform range. If yes, set the trigger level to the middle or set the mode to “Auto” .

Note: using **AUTO** could automatically finish the above setting.

6. The display of waveform is ladder-like:

- 1) The horizontal time base might be too low. Increase the horizontal time base to increase the horizontal resolution and improve the display.
- 2) If the display **Type** is “Vectors” , the lines between the sample points may cause ladder-like display. Set **Type** to “Dots” to solve the problem.

7. Fail to connect PC through USB:

Check the **IO Setting** in **Utility** to ensure whether the USB device setting matches the device currently connected. If needed, restart the oscilloscope.

8. The USB storage device cannot be recognized:

- 1) Check whether the USB storage device can work normally.
- 2) Make sure whether the USB interface can work normally.
- 3) Make sure that the USB storage device being used is flash storage type. This oscilloscope does not support hardware storage type.
- 4) Restart the instrument and then insert the USB storage device to check it.
- 5) If the USB storage device still cannot be used normally, please contact **SIGLENT**.

9. The multimeter measurements aren't correct:

- 1) Check that if the range of the SHS800X/SHS1000X matches with the measured item.
- 2) Make sure that if the multimeter is beyond the calibration date. If the measurements and real values are beyond the relevant precision, please contact the calibration site warranted by the SIGLENT company to calibrate the SHS800X/SHS1000X.
- 3) If you can't use the SHS800X/SHS1000X normally all the same, please contact **SIGLENT**.

SHS800X/SHS1000X

Handheld Digital Oscilloscope



About SIGLENT

SIGLENT is an international high-tech company, concentrating on R&D, sales, production and services of electronic test & measurement instruments.

SIGLENT first began developing digital oscilloscopes independently in 2002. After more than a decade of continuous development, SIGLENT has extended its product line to include digital oscilloscopes, isolated handheld oscilloscopes, function/arbitrary waveform generators, RF/MW signal generators, spectrum analyzers, vector network analyzers, digital multimeters, DC power supplies, electronic loads and other general purpose test instrumentation. Since its first oscilloscope was launched in 2005, SIGLENT has become the fastest growing manufacturer of digital oscilloscopes. We firmly believe that today SIGLENT is the best value in electronic test & measurement.

Headquarters:

SIGLENT Technologies Co., Ltd
Add: Bldg No.4 & No.5, Antongda Industrial
Zone, 3rd Liuxian Road, Bao'an District,
Shenzhen, 518101, China
Tel: + 86 755 3688 7876
Fax: + 86 755 3359 1582
Email: sales@siglent.com
Website: int.siglent.com

North America:

SIGLENT Technologies America, Inc
6557 Cochran Rd Solon, Ohio 44139
Tel: 440-398-5800
Toll Free: 877-515-5551
Fax: 440-399-1211
Email: info@siglentna.com
Website: www.siglentna.com

Europe:

SIGLENT Technologies Germany GmbH
Add: Staetzlinger Str. 70
86165 Augsburg, Germany
Tel: +49(0)-821-666 0 111 0
Fax: +49(0)-821-666 0 111 22
Email: info-eu@siglent.com
Website: www.siglenteu.com

Follow us on
Facebook: [SiglentTech](https://www.facebook.com/SigentTech)

