



SSG3000X Signal Generator

User Manual

UM0803X -E01A

Guaranty and Declaration

Copyright

SIGLENT TECHNOLOGIES CO., LTD All Rights Reserved.

Trademark Information

SIGLENT is the registered trademark of **SIGLENT TECHNOLOGIES CO., LTD**

Declaration

- ◆ **SIGLENT** products are protected by patent law worldwide
- ◆ **SIGLENT** reserves the right to modify or change parts of or all the specifications or pricing policies at company's sole decision.
- ◆ Information in this publication replaces all previously corresponding material.
- ◆ Any way of copying, extracting or translating the contents of this manual is not allowed without the permission of **SIGLENT**.
- ◆ **SIGLENT** will not be responsible for losses caused by either incidental or consequential in connection with the furnishing, use or performance of this manual as well as any information contained.

Product Certification

SIGLENT guarantees this product conforms to the national and industrial standards in China as well as the ISO9001: 2008 standard and the ISO14001: 2004 standard. Other international standard conformance certification is in progress.

General Safety Summary

Carefully read the following safety precautions to avoid any personal injury or damage to the instrument and any products connected to it. To avoid potential hazards, please use the instrument as specified.

Use Proper AC Power Line

Only the power cord designed for the instrument and authorized by local country should be used.

Ground the Instrument

The instrument is grounded through the protective earth conductor of the power line. To avoid electric shock, please make sure the instrument is grounded correctly before connecting its input or output terminals.

Connect the Probe Correctly.

If a probe is used, do not connect the ground lead to high voltage since it has isobaric electric potential as the ground.

Look Over All Terminals' Ratings

To avoid fire or electric shock, please look over all ratings and sign instruction of the instrument. Before connecting the instrument, please read the manual carefully to gain more information about the ratings.

Use Proper Overvoltage Protection

Make sure that no overvoltage (such as that caused by a thunderstorm) can reach the product, or else the operator might be exposed to danger of electrical shock.

Electrostatic Prevention

Operate the instrument in an electrostatic discharge protective area environment to avoid damages induced by static discharge. Always ground both the internal and external conductors of the cable to release static before connecting.

Maintain Proper Ventilation

Inadequate ventilation may cause increasing of the instrument's temperature, which will eventually damage the instrument. So keep well ventilated and inspect the intake and fan

regularly.

Avoid Exposed Circuit or Components

Do not touch exposed contacts or components when the power is on.

Do Not Operate Without Covers

Do not operate the instrument with covers or panels removed.

Use Only the Specified Fuse.

Keep Product Surfaces Clean and Dry.

To avoid the influence of dust and/or moisture in the air, please keep the surface of the device clean and dry.

Do Not Operate in Wet Conditions.

In order to avoid short circuiting to the interior of the device or electric shock, please do not operate the instrument in a humid environment.

Do Not Operate in an Explosive Atmosphere.

In order to avoid damage to the device or personal injury, it is important to operate the device away from an explosive atmosphere.

Safety Terms and Symbols

Terms used in this manual:

DANGER: Indicates an injury or hazard that may immediately happen.

WARNING: Indicates an injury or hazard that may not immediately happen.

CAUTION: Indicates that a potential damage to the instrument or other property might occur.

Symbols used on the instrument. Symbols may appear on the instrument:



Hazardous

Voltage



Protective

Earth Ground



Warning



Chassis

Ground

SSG3000X Overview

The SIGLENT SSG3000X series is a bench top RF signal source, with an output frequency range from 9 kHz to 3.2 GHz. It features light weight, small size, and convenient interface make it ideal for R&D, education, production, and maintenance.

Features and Benefits

- ◆ Frequency range from 9 kHz up to 3.2 GHz
- ◆ 0.01Hz frequency resolution
- ◆ Level output from -110dBm~+20dBm.
- ◆ 0.01dBlevel resolution
- ◆ Level accuracy $\leq 0.7\text{dB}(\text{typ.})$
- ◆ Phase noise: $<-110\text{dBc/Hz @1GHz, offset 20kHz}(\text{typ.})$
- ◆ Standard AM, FM, and PM analog modulation with internal, external and Int+Ext source
- ◆ Pulse modulation, on/off ratio $\geq 0.7\text{ dB}(\text{typ.})$
- ◆ Pulse train generator(option)
- ◆ External IQ modulation with SDG6000X as the Baseband IQ signal
- ◆ USB-power meter measurement
- ◆ Equipped with a 5-inch (800x480) with display and a capacitive touch screen for easy and convenient operation.

Contents

Guaranty and Declaration	II
General Safety Summary	III
Safety Terms and Symbols	V
SSG3000X Overview	VI
Chapter 1 Quick Start	1
1.1 Appearance size	2
1.2 Preparing for Use	3
1.2.1 Adjust the Supporting Legs	3
1.2.2 Connect to AC Power Supply	3
1.3 The Front Panel	4
1.3.1 Front Panel Function Keys	4
1.3.2 Front Panel Key Backlight	5
1.3.3 Digital keyboard	6
1.3.4 Front Panel Connectors	8
1.4 Rear Panel	9
1.5 User interface	13
1.6 Touch operation	15
1.7 Parameter setting	16
1.8 Help information	17
Chapter 2 Front Panel Operation	18
2.1 Frequency Setting	19
2.1.1 RF output Frequency	19
2.1.2 Freq Offset	20
2.1.3 Phase Offset	21
2.2 LevelSetting	23
2.2.1 Level setting	23
2.2.2 Level Offset	24
2.2.3 ALC State	25
2.2.4 Flatness	26

2.3	SweepSetting.....	29
2.3.1	Sweep State.....	29
2.3.2	Step Sweep.....	29
2.3.3	List sweep.....	30
2.3.4	Direction.....	32
2.3.5	Sweep Mode.....	32
2.3.6	Trigger Mode.....	32
2.3.7	Point Trigger.....	33
2.3.8	Trigger Slope.....	34
2.4	Modulation Setting.....	36
2.4.1	Amplitude Modulation (AM).....	36
2.4.2	Frequency Modulation (FM).....	39
2.4.3	Phase Modulation (PM).....	41
2.4.4	Pulse Modulation (PULSE).....	44
2.5	LF Setting.....	54
2.5.1	LF Source.....	54
2.5.2	LF Sweep.....	55
2.6	Utility.....	58
2.6.1	System.....	58
2.6.2	Store/Recall.....	65
2.7	Power Sensor.....	68
2.7.1	Power meter setting.....	68
2.7.2	Level Control.....	72
2.8	I/Q Modulation.....	74
2.8.1	Turning on I/Q modulation.....	74
2.8.2	I/Q source.....	74
2.9	Shortcut Keys.....	75
2.9.1	Preset.....	75
2.9.2	Home.....	78
2.9.3	Trigger.....	78

2.9.4	Esc/Close.....	78
2.9.5	Mod ON/OFF	79
2.9.6	RF ON/OFF.....	79
Chapter 3	Application Examples.....	80
3.1	Output RF signal	80
3.2	Output a modulated signal	81
3.3	Output a pulse train.....	83
3.4	Output IQ modulated signal	85
3.5	Test the OIP3 of Active Devices with the SSG3000X.....	88
Chapter 4	Programming Overview	91
4.1	Remote Operation.....	91
4.1.1	Connecting via the USB Device port	91
4.1.2	Connecting via the LAN port.....	92
4.1.3	GPIB: Connecting via the USB-Host port.....	93
4.2	Build Communications	94
4.2.1	Build Communications Using VISA	94
4.2.2	Build Communications Using Sockets/Telnet.....	96
4.3	Remote Control Capabilities	97
4.3.1	User-defined Programming	97
4.3.2	Send SCPI Commands via NI MAX	97
4.3.1	Web Control	100
Chapter 5	Service and Support	101
5.1	General Inspection	101
5.2	Troubleshooting	101
Chapter 6	Service and Support	105
6.1	Service Summary.....	105
6.2	Contact Us	106

Chapter 1 Quick Start

Subjects in this chapter:

- ◆ Appearance Appearance size
- ◆ Preparing for Use
- ◆ The Front Panel
- ◆ Rear Panel
- ◆ User interface
- ◆ Touch operation
- ◆ Parameter setting
- ◆ Help information

1.1 Appearance size

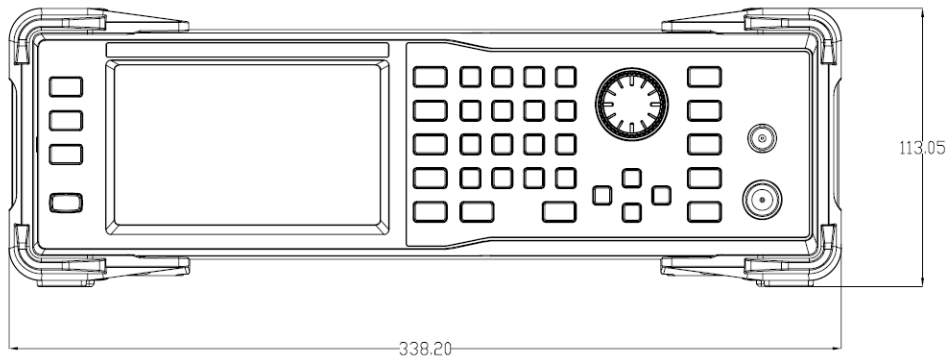

Figure 1-1 Front View

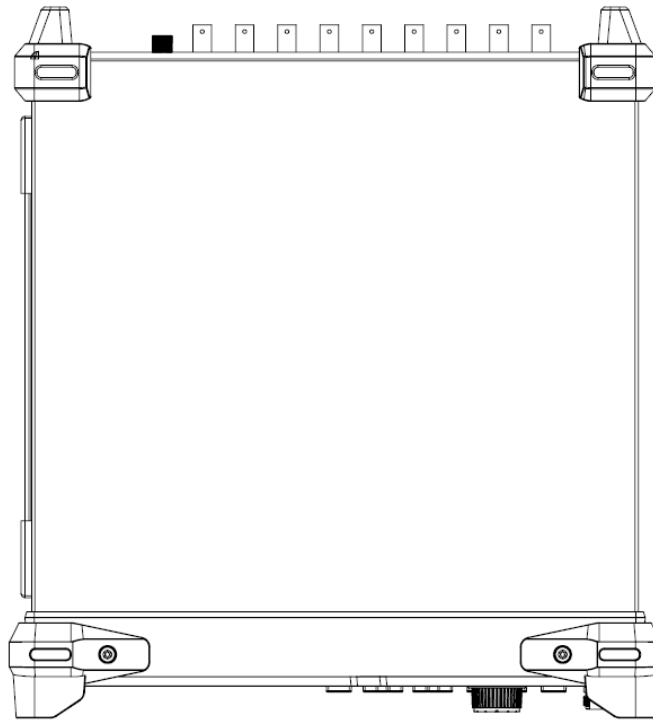

Figure 1-2 Top View

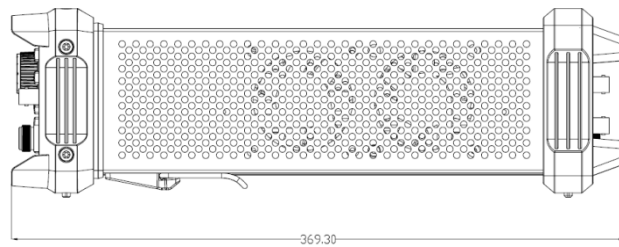

Figure 1-3 Side View

1.2 Preparing for Use

1.2.1 Adjust the Supporting Legs

For benchtop operation, you may want to use the supporting legs. Adjust the supporting feet appropriately to tilt the RF signal source upwards.

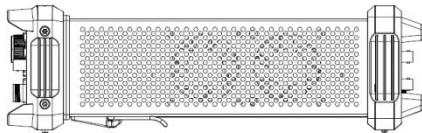

Figure 1-4 before adjusting

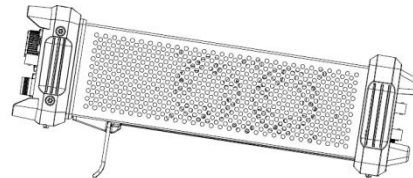

Figure 1-5 after adjusting

1.2.2 Connect to AC Power Supply

The RF signal source accepts 100-240V, 50/60/440Hz AC power supply. Please use the power cord provided to connect the instrument to the power source as shown in the figure below.

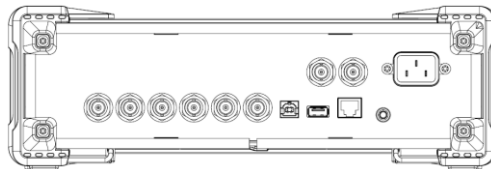

Figure 1-6 Power Interface

1.3 The Front Panel

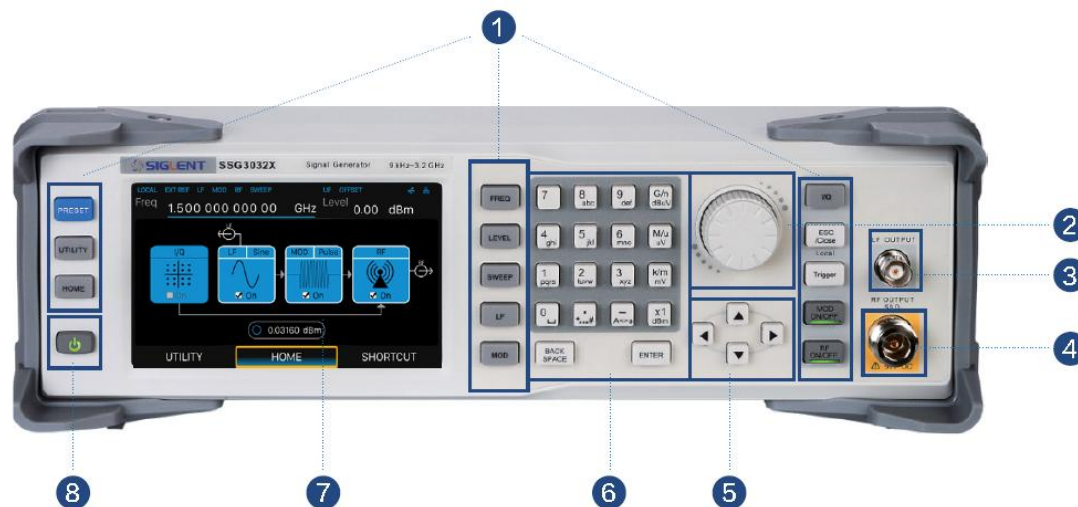

Figure 1-7 the Front Panel

Table 1-1 Front Panel Description

NO.	Description	NO.	Description
1	Function key	2	Knob
3	LF output	4	RF output
5	Direction key	6	Digital keyboard
7	Touch screen display area	8	Power button

1.3.1 Front Panel Function Keys

Table 1-2 Function keys description

Control Keys	Description
FREQ	Set frequency, frequency offset, phase offset and other related parameters.
LEVEL	Set level, level offset, ALC state, flatness and other parameters, power sensor display and control functions.
SWEEP	Set sweep state, step sweep, list sweep, direction and other related

	parameters.
LF	Set LF state, LF level, LF frequency and other related parameters.
MOD	Set various modulation parameters (AM, FM, PM and PULSE).
I/Q	Set IQ related parameters
ESC/Close	During the parameter or editing process, pressing this key will clear the input of the active function area and exit the parameter input state. Press this button to return to local control of previously operating the instrument remotely.
Trigger	When the trigger type is set to Key, press this button to perform one operation.
MOD ON/OFF	The main switch of various modulation modes.
RF ON/OFF	RF signal output switch
PRESET	Press this button to revert to the default parameter. The default parameters refer to the default parameter table.
UTILITY	System and file related operations
HOME	You can get back to the main interface quickly

1.3.2 Front Panel Key Backlight

The on/off state and the color of the backlights of some keys at the front panel indicate the working state of the SSG. The states are as listed below.

1. Power Switch

- ◆ Light on and off alternatively, in breathing state: indicate the unit is in stand-by state.
- ◆ Constant on: indicate the instrument is in normal operating state.

2. **Mode ON/OFF**

When the Mode ON/OFF is set to turn on the modulation, the light will turn on, turn off the

modulation, and the lights will turn off.

3. **RF ON/OFF**

When the RF signal is turned on, the back light is on, and the radio signal is turned off.

1.3.3 Digital keyboard

The front panel of the RF signal source provides a numeric keypad (as shown below). The keyboard supports English uppercase and lowercase characters, numbers, and common symbols (including decimal points, blanks, spaces, and + /), mainly for editing the name of files or folders and setting parameters (refer to the "parameter setting" section).



Figure 1-8 Digital keyboard

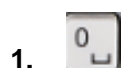

Digit 0 and space bar switch.



In the English state, enter the special symbol!, @, #, \$, %, ^, &, *) In the digital state, enter the decimal point.



In the digital state, enter the "-" number, in the English state input for case switching.



When setting the amplitude, press this key to set the units as dBuV. When setting the

frequency, press this key to set the units as GHz, if the input is a time-related parameter, press this key to set the unit tons.

5. 

When setting the amplitude, press this key to set the units as uV. When setting the frequency, press this key to set the units as MHz, if the input is a time-related parameter, press this key to set the unit to us.

6. 

When setting the amplitude, press this key to set the units as mV. When setting the frequency, press this key to set kHz. If the input is a time-related parameter, press this key to set the unit to ms.

7. 

When setting the amplitude, press this key to set the units as dBm unit, when setting a frequency, the unit is Hz, if the input is a time correlation parameter, press this key to set the units as s.

8. 

During the parameter or editing process, pressing this key will clear the input of the active function area and exit the parameter input state.

9. 

In the parameter input process, pressing this key will end the parameter input and add the currently set units for the parameter.

1.3.4 Front Panel Connectors

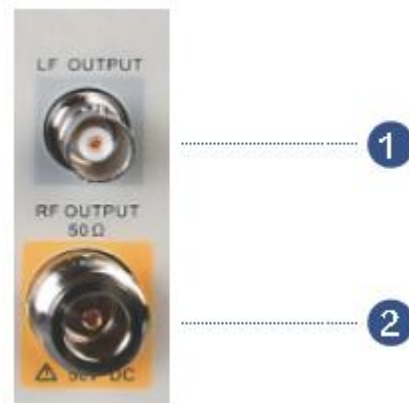

Figure 1-9 front panel connectors

1. LF (low frequency) output

Output the low frequency signal. This is a BNC connection. The output can also be configured to source the modulation waveform for FM and PM modulation types.

2. RF(Radio frequency) output terminal

RF signal output N-type connector with an impedance of 50 ohms.

1.4 Rear Panel

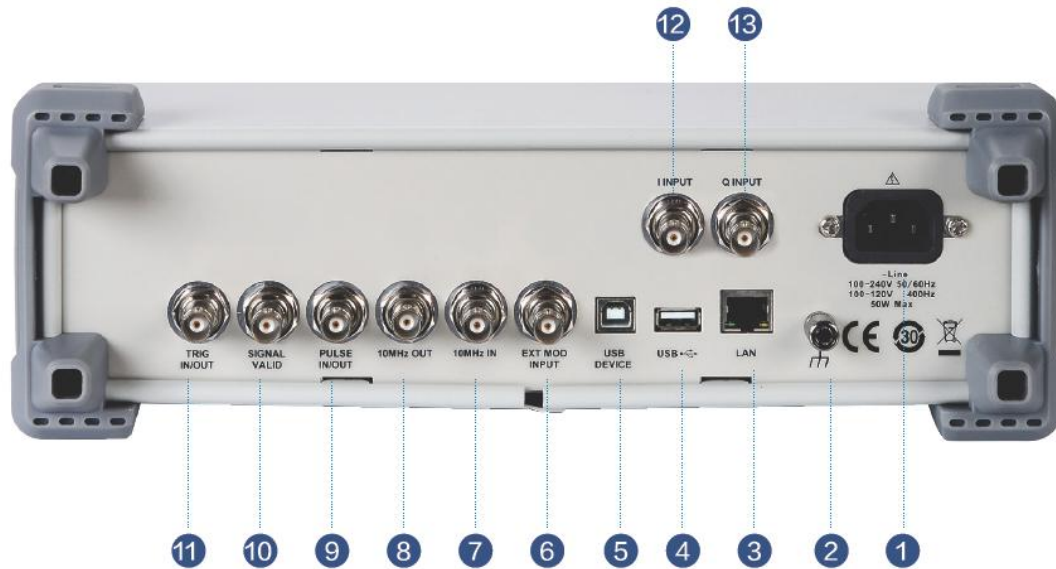

Figure 1-10 Rear Panel

1. AC power input terminal

The RF signal source can operate with AC power from specifications of the AC power supply supported by RF signal source are 100 V - 240 V at 45 Hz - 440 Hz. Please connect the RF signal source to the AC power supply with the supplied power cord.

2. Ground

System ground terminal.

3. LAN interface

Used to link the RF signal source to the computer or computer network, the SSG3000X is VXI-11 compliant, supports remote commands based on Socket and Telnet, and uses WEB for remote control. It can quickly build test systems with other standard equipment.

4. USB host

The RF signal source can be used as the "main device" to connect to the external USB device. The interface reads the trace or state file from the U disk, or stores the current instrument state or trace to the U disk, and can also save the content displayed on the current screen in .BMP format to the U disk.

5. USB Device interface

The interface can be connected to a compatible computer and controlled by software on the host computer

6. EXT MOD INPUT

Input BNC connection for an external modulation.

7. 10MHz IN

The **[10MHz IN]** and **[10MHz OUT]** connectors are commonly used to establish synchronization between multiple instruments. The RF source can use an internal reference source or an external reference source.

If the instrument detects that there is a valid 10MHz IN signal at the 10MHz In connector, it will use it as an external reference source. At this point the user interface status bar shows "Ext Ref". When an external reference is lost, exceeded, or disconnected, the instrument automatically switches to the internal reference, and the screen status bar will no longer display "Ext Ref".

8. 10MHz OUT

The **[10MHz IN]** and **[10MHz OUT]** connectors are commonly used to establish synchronization between multiple instruments. The RF source can use an internal reference source or an external reference source.

If the instrument uses an internal reference source, the [10MHz OUT] connector can output a 10MHz clock signal generated by the instrument and can be used to synchronize other devices.

9. PULSE IN/OUT

The function of the connector is determined by the current mode of pulse modulation.

1) PULSE IN:

When the pulse source is "Ext", it is used to input external pulse signals.

2) PULSE OUT:

When the Pulse modulation source is "Int" and the pulse output switch is turned on, it is used to output the pulse signal generated by the internal generator. The output signal is related to "Pulse Mode", and can be set to "Single", "Double" or "Train".

10. SIGNAL VALID

When the RF output frequency or amplitude is modified, the RF output connector of the front panel outputs the RF signal at the specified frequency and amplitude after a certain response and processing time in the internal circuit of the instrument. In this process, the **[SIGNAL VALID]** connector outputs an impulse synchronization signal to indicate the validity of the RF output signal:

- High level (3.3 V): Indicates that the RF signal is being configured;
- Low level (0 V): Indicates that the RF signal is stable (effective).

11. TRIG IN/OUT

When PULSE trigger mode is "Int", the connector can be used to output the trigger signal.

When the RF Sweep, LF Sweep, or PULSE trigger mode is "Ext", the connector is used to input the external trigger signal.

12. I INPUT

Used to input an external modulated I baseband signal when the external IQ modulation mode is on.

13. Q INPUT

Used to input an external modulated Q baseband signal when the external IQ modulation mode is on.

Note: **[I INPUT]** and **[Q INPUT]** connectors are only available on models equipped with IQ modulation.

1.5 User interface

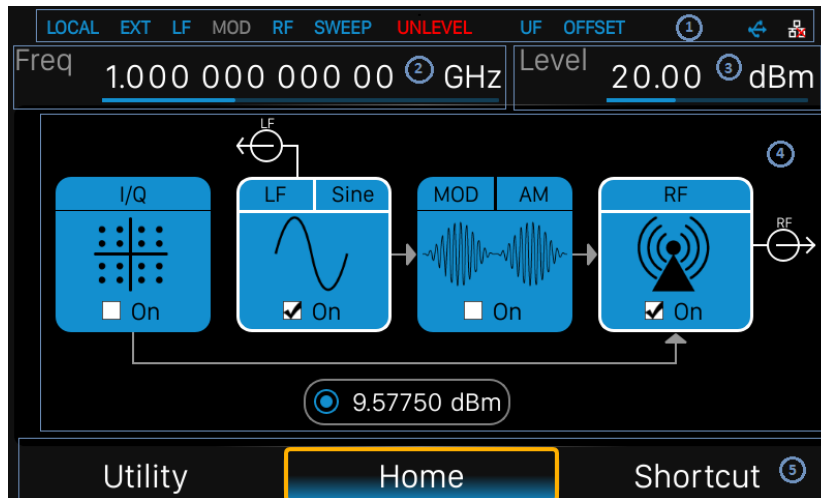





Figure 1-11 User Interface

1. Prompt status bar

- Display Local (local), Remote (remote). When Remote is displayed, the instrument is being controlled by a remote computer and the front panel input will be locked. To unlock the front panel (enter Local mode).Esc/Close to quit.
- Ext: Ext Ref shows that the SSG is using an external 10 MHz reference.
- LF: Low frequency signal generator state.
- MOD: The modulation state mode is turned off, the blue is turned on, and the gray is closed.
- RF: The RF output state.
- SWEEP: The status of the sweep state.UNLEVEL: Indicates that the amplitude accuracy may not be within the scope of the specification index.
- UF: Amplitude flatness function enable.
- OFFSET: Amplitude offset enable.
- : The identification is displayed when a USB disk is inserted
- LAN: LAN state.  Indicates that LAN is successfully connected.  indicates that there is no network connection or network connection failed

2. RF frequency

RF output frequency setting. When the scan type is "frequency" or "frequency & amplitude", the frequency scanning progress bar is displayed.

3. RF level

RF output level setting. When the scan type is "amplitude" or "frequency & amplitude", the level scanning progress bar is displayed.

4. Touch screen display area: Display the settings under each menu

- I/Q: I/Q output state
- LF: LF output state and LF waveform displayed. Sine, Square, Sawtooth, Triangle and DC can be set up.
- MOD : Modulation state. Amplitude modulation, frequency modulation, phase modulation, or pulse can be set.
- RF: RF output state.
- Power sensor: Display the current reading of the power sensor after accessing the power sensor.

5. Menu

Switch menu and display menu after entering each function.

1.6 Touch operation

The RF signal source provides a 5 inch capacitive touch screen to support various gesture operations. Including:

- ◆ Click on the screen parameters or menu to edit the parameters.
- ◆ Left or right slide switches menus.
- ◆ Up and down slides the display menu

Note: Only when you click on the screen, the scrollbar appears on the right to slide down the menu. If there is no scrollbar, it means that only the current page exists.

1.7 Parameter setting

Parameter input can be performed through touch screen, keypad and digital keys, knob or direction keys. This section introduces an example of three parameter setting methods by setting the center frequency to 100 MHz.

1. Using the digital keyboard

- 1) Press **FREQ**;
- 2) Use the numeric key to input the value "100";
- 3) Then press  to select unit MHz;

2. Using the touch screen

- 1) Click the **Freq** input box on the screen to display the keypad.
- 2) Enter 100 on the keypad, then select unit MHz on the keypad.

3. Using the knob and the direction key

- 1) Bring the Focus Cursor on the **Freq** input box by using the knob.
- 2) Press the knob and adjust the left and right arrow keys to select the digit you wish to adjust.
- 3) Then turn the knob or press the up and down arrow keys to change the parameters until the desired value is obtained.

1.8 Help information

The built-in help system of RF signal source provides help information for each function and menu option on the front panel.

- ◆ Press **UTILITY** button and select help. The center of the screen will pop up to help.
- ◆ Click to enter the corresponding directory.

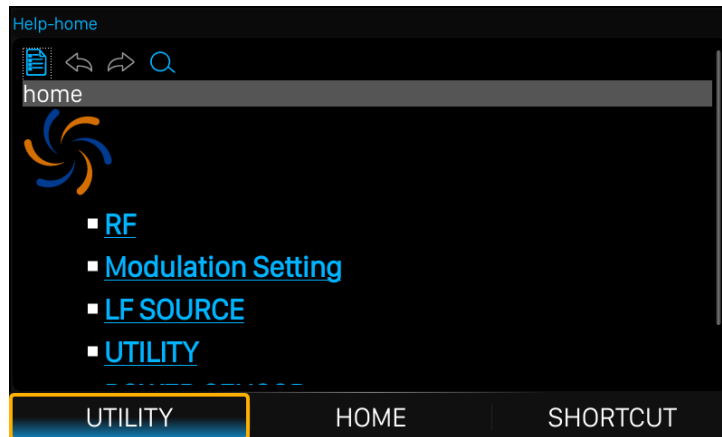

Figure 1-12 help information

Chapter 2 Front Panel Operation

This chapter describes in detail the function keys at the front panel and the associated functions.

Subjects in this chapter:

- ◆ Frequency Setting
- ◆ LevelSetting
- ◆ Sweep Setting
- ◆ Modulation Setting
- ◆ LF Setting
- ◆ Utility
- ◆ Power Sensor
- ◆ IQ modulation
- ◆ Shortcut Keys

2.1 Frequency Setting

The value of the RF frequency is displayed in the header of the display (“Freq”). This field provides the direct input of the RF frequency. Alternatively, you can enter the RF frequency in the “Freq” dialog.

Note that the displayed RF frequency in the header and the RF output frequency, entered in the “FREQ” dialog can be different, as explained in the following section.

If you working with a downstream instrument, e.g. a mixer, you can enter related parameter value in the frequency settings dialog (“Offset”).

The correlation between the RF frequency, the RF output frequency and the frequency offset is as follows:

“FREQ” (in header) = “RF output frequency” (frequency in dialog) + “Freq offset” (offset in dialog)

2.1.1 RF output Frequency

Setting the RF output frequency

1. Keypad operation

Press **FREQ** → **Frequency** to make the focus fall on this parameter item.

- Use the numeric keypad to input the desired value and press the unit button to select the desired unit. Optional units are GHz, MHz, kHz, and Hz. Press **ENTER** to select the current unit.
- Press **ENTER** or press the knob to enter the parameter editing state, and then use the left and right direction keys to move the cursor to the desired position. Press the up and down direction keys, rotate the knob or press the numeric keypad to modify the value. Press **ENTER**, knob or **ESC** to exit the editing mode.

2. Touch screen operation

Click on **SHORTCUT**->**FREQ**->**Frequency** to enter the interface of RF output frequency setting.

- Click the frequency parameter, then pop up the keypad interface, then click the number symbol in the keypad to change the value. Click the unit to modify the unit. Click the tick to confirm the modified value and selected unit.
- Long press edit box to enter the edit mode. Press the up and down direction keys, rotate the knob or press the numeric keypad to modify the value, and press the **ENTER** key, knob or **ESC** key to exit the edit mode.

Note: The maximum RF output frequency is 3.2 GHz, and 9 kHz is the minimum.

2.1.2 Freq Offset

This setting the displayed frequency offset from the RF output signal.

This can be useful if the circuit or device shifts or alters the output frequency .such as an external mixer, by setting an offset; you can read the mixer signal's frequency directly on the RF generator front panel.

1. Keypad operation

Press **FREQ**->**Freq Offset** to make the focus fall on this parameter item.

- Use the numeric keypad to input the desired value and press the unit button to select the desired unit. Optional units are GHz, MHz, kHz, and Hz. Press **ENTER** to select the current unit.
- Press **ENTER** or press the knob to enter the parameter editing state, and then use the left and right direction keys to move the cursor to the desired position. Press the up and down direction keys, rotate the knob or press the numeric keypad to modify the value. Press **ENTER**, knob or **ESC** to exit the editing mode.

2. Touch screen operation

Click **SHORTCUT**->**FREQ**-> **Freq Offset** to enter the interface of frequency offset setting.

- Click the frequency offset parameter, and then pop up the keypad interface, then click the number symbol in the keypad to change the value. Click the unit to modify the unit. Click the check mark to confirm the modified value and selected unit.
- Long press the edit box to enter the edit mode. Press the up and down direction keys, rotate the knob or press the numeric keypad to modify the value, and press the **ENTER** key, knob or **ESC** key to exit the edit mode.

Note:

- The relationship between the RF output frequency, the display frequency and frequency offset is:
$$\text{Display frequency} = \text{RF output Frequency} + \text{Frequency offset}$$
- The difference value between the display frequency and the frequency offset is the actual RF output frequency, which must not exceed the instrument frequency output range.

2.1.3 Phase Offset

Setting the phase offset from the RF signal

Application:When multiple RF sources are outputting RF signals at the same time, multiple signals can be output to the same phase or a fixed phase offset by adjusting this parameter.

Also you should set the devices the same frequency and synchronous them.

1. Keypad operation

Press **FREQ**-> **Phase Offset** to make the focus fall on this parameter item.

- Use the numeric keypad to input the desired value and press the unit button to select the desired unit. Press **ENTER** to select the current unit.

SIGLENT

- Press **ENTER** or press the knob to enter the parameter editing state, and then use the left and right direction keys to move the cursor to the desired position. Press the up and down direction keys, rotate the knob or press the numeric keypad to modify the value. Press **ENTER**, knob or **ESC** to exit the editing mode.

2. Touch screen operation

Click on **SHORTCUT->FREQ->Phase Offset** to enter the interface of phase offset setting.

- Click the phase offset parameter, then pop up the keypad interface, then click the number symbol in the keypad to change the value. Click the unit to modify the unit. Click the check mark to confirm the modified value and selected unit.
- Long press the edit box to enter the edit mode. Press the up and down direction keys, rotate the knob or press the numeric keypad to modify the value, and press the **ENTER** key, knob or **ESC** key to exit the edit mode.

Click on **SHORTCUT->FREQ->Reset phase delta display** to reset the display phase offset to 0 deg.

2.2 LevelSetting

The value of the RF level is displayed in the level text field located in the header of the display (labeled "Level"). This field provides the direct input of the RF level value. Alternatively, you can enter the level in the level dialog.

Note that the displayed RF level in the header, and the RF output level, set in the "Level" dialog can be different, as explained in the following section.

If you working with a downstream instrument, e.g. an attenuator or amplifier, you can enter the level offset value in the settings dialog (labeled "Level Offset").

The generator includes these parameters and displays the result in the "Level" field in the status bar, as if the downstream source and the generator were one unit. This displayed level value corresponds to the value at the RF output of the instrument and any downstream sources. However, the level provided at the RF output of the signal generator corresponds to the level value set in the "Level Setting" dialog.

When a level offset is enabled, the instrument display changes the color of "OFFSET" from grey to blue.

Level (in header) = RF output level (level in the Level menu) + Level offset (Offset in Level menu)

2.2.1 Level setting

Setting the RF signal level

1. Keypad operation:

Press the **LEVEL** -> **Level** to make the focus fall on this parameter item

- Use the numeric keypad to input the desired value and press the unit button to select the desired unit. Optional units are dBm, dBuV, uV, mV, V, nW, uW, mW and W. Press **ENTER** to select the current unit by default.
- Press **ENTER** or press the knob to enter the parameter editing state, and then use the left and right direction keys to move the cursor to the desired position. Press the up and down direction keys, rotate the knob or press the numeric keypad to modify the value. Press **ENTER**, knob or **ESC** to exit the editing mode.

2. Touch screen operation

Click on **SHORTCUT** -> **LEVEL** -> **Level** to enter the interface of RF output level setting.

- Click the level parameter, then pop up the keypad interface, then click the number symbol in the keypad to change the value. Click the unit to modify the unit. Click the check mark to confirm the modified value and selected unit.
- Long press edit box to enter the edit mode. Press the up and down direction keys, rotate the knob or press the numeric keypad to modify the value, and press the **ENTER** key, knob or **ESC** key to exit the edit mode.

2.2.2 Level Offset

Setting the level offset from the RF signal's level

Application: When connecting a fixed attenuation or gain, the level value after attenuation or amplification can be directly read and set on the RF source by setting a level offset.

When level offset is not zero, the status bar will display OFFSET in blue.

1. Keypad operation

Press **LEVEL** -> **Level Offset** to make the focus fall on this parameter item.

- Use the numeric keypad to input the desired value. Press **ENTER** or click the check

mark to confirm.

- Press **ENTER** or press the knob to enter the parameter editing state, and then use the left and right direction keys to move the cursor to the desired position. Press the up and down direction keys, rotate the knob or press the numeric keypad to modify the value. Press **ENTER**, knob or **ESC** to exit the editing mode.

2. Touch operation

Click on **SHORTCUT**->**LEVEL**->**Level Offset** to enter the interface of level offset setting.

- Click the level parameter, then pop up the keypad interface, then click the number symbol in the keypad to change the value. Click the check mark to confirm the modified value.
- Long press edit box to enter the edit mode. Press the up and down direction keys, rotate the knob or press the numeric keypad to modify the value, and press the **ENTER** key, knob or **ESC** key to exit the edit mode.

Note:

- The difference value between the display level and the level offset is the actual RF output level, which must not exceed the instrument level output range.

2.2.3 ALC State

Setting the ALC's working state

ALC is Automatic Level Control .It is an adaptive control system to stabilize the RF output level.

It continuously monitors the current level and adjusts it to keep a steady state over temperature and time.

1. Keypad operation

Press **LEVEL**-> **ALC State** to expand the drop-down box, then rotate the knob or press the up and down direction keys to select ALC state.

2. Touch operation

Click on **SHORTCUT**->**LEVEL**->**ALC state** to select ALC state.

ALC has three functions: "Off", "On" and "Auto":

- **AUTO**

Automatically turn on or off the ALC function according to the equipment state.

- **On**

Enable ALC permanently, regardless of the currently selected mode.

- **ALC Off (S&H)**

Deactivate ALC. The instrument switches to Sample & Hold (S&H) state, which still allows maintaining a constant output level. In "S&H" mode, the signal generator switches for a short period of time into CW mode and activates ALC. The ALC adjusts the level to the set value and the generator holds the value. Then, the generator switches ALC off again and back to the previous operating mode.

2.2.4 Flatness

The "Flatness" function adjusts the amplitude at specific frequencies by mathematically adjusting the output by applying user-defined level correction lists. Correction is performed by the user-defined table values being added to the output level for the respective RF frequency. With frequencies which are not contained in the list, the level correction is determined by interpolation of the closest correction values. If there is only one point, it will not perform correction.

The flatness correction function can adjust the RF output amplitude corresponding to the

frequency point within the frequency range of the instrument to compensate for losses in the cable, or losses caused by other equipment.

1. Flatness Menu

- Keypad operation

Press **LEVEL**->**Flatness** to make the focus fall on the flatness menu, then press the knob or **ENTER** key to switch flatness status. When opened, the status bar displays the blue UF letters.

- Touch operation

Click on **SHORTCUT**->**LEVEL** ->**Flatness** to make the focus fall on flatness switch. Then click on the switch button to switch the flatness status.

Note: Flatness correct is enabled when the indicator shows the blue colored “1” and the status bar will display blue “UF”.When disabled,the Flatness indictor will display a grey “0”.

2. Flatness settings

Press **LEVEL**->**Flatness**, and then click the gear icon to enter the flatness list edit page.

Table 2-1 Flatness correction list

ROW	Frequency	correction (dB)
1		
2		

1) Inset

Press  to insert a new row after the last row.

2) Delete

Press  to delete the selected row.

3) Empty

Press  to empty any number of rows.

4) Load

Press  to enter the file save/call page, select and load existing flatness correction files, see "file management" for details.

5) Save

Press  to enter the file save/call page, save the correction data in the list, see "file management" for details.

6) Return

Press  return to the previous menu.

2.3 Sweep Setting

When the RF sweep function is enabled, the RF signal is output from the N-type connector of [RF OUTPUT 50Ω] on the front panel.

Note: The RF signal will be on only when the RF switch is on.

Press **SWEEP** to enter RF sweep setting.

2.3.1 Sweep State

The sweep state is off by default. The signal generator SSG3000X offers three different RF sweep types: Freq, Level, and Freq& Level.

Clicking the drop-down box of the sweep state to choose a sweep type:

- Off: Default state. The sweep disabledClose RF sweep function.
- Freq: Enable frequency sweep. The frequency parameter bar refreshes the current frequency value in real time and the current sweep progress can be observed on the frequency sweep progress bar.
- Level: Enable level sweep. The frequency parameter bar refreshes the current level value in real time and the current sweep progress can be observed on the level sweep progress bar.
- Freq& Level: Enable frequency sweep and level sweep function. The frequency and level parameter bar refreshes the current frequency and level value in real time and the current sweep progress can be observed on the frequency and level sweep progress bar.

2.3.2 Step Sweep

The step sweep state is on by default. Click the slide to switch the on-off state. Click the



to enter the parameter setting menu of step sweep.

Note: The step sweep and list sweep are mutually exclusive. One will shut off

automatically when the other is on.

- 1) Start Freq: Initial frequency setpoint of the sweep.
- 2) Stop Freq: Final frequency setpoint of sweepsetting the stop sweep frequency.
- 3) Start Level: Initial amplitude level set point of the sweep
- 4) Stop Level:Final amplitude level set point of the sweep.
- 5) Dwell time: The interval time between two sweep points.
- 6) Sweep points:The number of points in a sweep .Every point is interpolated between the start parameter and stop parameter.
- 7) Sweep shape: Click the drop-down box, Sawtooth and triangle can be selected
 - Sawtooth: Sweep period is always from the start frequency or start level to the stop frequency or stop level. The sweep sequence is similar to a "Sawtooth wave".
 - Triangle: Sweep period is always from the start frequency or start level to the stop frequency or stop level, and then return back to the start frequency or start level. The sweep sequence is similar to a "triangle wave".
- 8) Sweep Space: Click the drop-down box, linear and log can be selected Note: Level sweep only support the line sweep mode. List Sweep





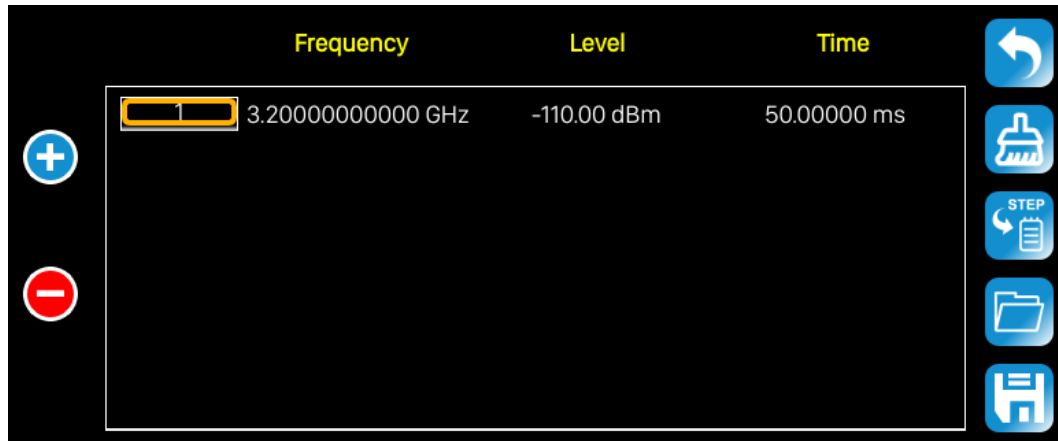

2.3.3 List sweep

The list sweep state is off by default. Click the slide to switch the on-off state. Click the "more setting" to enter the table edit page of list sweep.

Note: The List sweep and step sweep are mutually exclusive. One will shut off automatically when the other is on.



As show in the figure, the table edit page consists of the operating button on the left of page, the table on the middle of the page and the menu button on the right side.

- 1) Inset line: Click the  to inset a new line under the current cursor.
- 2) Delete line: Click the  to delete the line under the current cursor.
- 3) Parameter edit: Click each parameter in the table to set it through the touch screen keyboard or the keypad of the front panel.
- 3) Return to previous page: Click  to return to the previous menu.
- 4) Cleaning list: Click  to clean and preset current list.
- 5) Default step sweep list: Click  to generate a new list according to the step sweep setting.
- 6) Loading list: Click  button to enter the file system directory. At this time, the sweep list file previously saved in the device can be selected to read, and the parameter can be modified.
- 7) Save list: Click the  button to enter the file system directory. At this time, enter the file name, then save the sweep list file.

Note: Please refer to the related introduction in “File Management” for detailed operation of Loading/Saving files.

Each line parameter represents the setting of each sweep point:

- 1) Number: Indicates the row number of the sweep point.
- 2) Frequency: Indicates the frequency of the sweep point.
- 3) Level: Indicates the level of the sweep point.
- 4) Time: Indicates the dwell time of the sweep point.

2.3.4 Direction

Sweep direction state is “up” by default. The SSG3000X provides two types: “up” or “down”. Click the drop-down box to enable the corresponding sweep direction.

- UP: The signal generator sweeps from the start frequency or start level to the stop frequency or stop level. The progress bar displayed in the parameter bar is swept from left to right.
- DOWN: The signal generator sweeps from the stop frequency or stop level to the start frequency or start level. The progress bar displayed in the parameter bar is swept from right to left.

2.3.5 Sweep Mode

Default Sweep mode is “continuous”. The SSG3000X offers “continuous” or “single” sweep modes. Click the drop-down box to enable the desired mode.

- Continuous: When the trigger condition is met, the signal generator is continuously swept with the current settings.
- Single: When **Execute single sweep** is clicked, the signal generator executes a single sweep with the current settings.

2.3.6 Trigger Mode

The default trigger mode is “Auto”. The SSG3000X provides four types of trigger mode:

“Auto”, “Key”, “Bus” and “Ext”.

Click the drop-down box of the trigger mode to select the desired type:

- Auto: The default mode. If the sweep mode is “continuous”, just select one sweep type to start a sweep. If the sweep mode is “single”, then click the **Execute single sweep** button to start a one time sweep.
- Key: If the sweep mode is “continuous”, the device will start a one time sweep after you press the **Trigger** button on the front panel or click **Click to trigger** button on the touch screen. If the sweep mode is “single”, first click the **Execute single sweep** button, then a one time sweep will be started after you press the **Trigger** button on the front panel or click **Click to trigger** button on the touch screen.
- Bus: If the sweep mode is “continuous”, the device will start a one time sweep after receiving a “*TRG” command over the communications bus (USB or LAN) from a controlling computer. If the sweep mode is “single”, click the **Execute single sweep** button first, then send a “*TRG” command to start a one time sweep.
- External: The device receives the trigger signal input from the **[TRIGGER IN]** connector on the back panel. If the sweep mode is “continuous”, the device will start a one time sweep after receiving a specified polarity TTL pulse. If the sweep mode is “single”, click the **Execute single sweep** button firstly and then the device will start one time sweep after receiving a specified polarity TTL pulse.

2.3.7 Point Trigger

The default point trigger mode is “Auto “. The SSG3000X provides four types of point trigger: “Auto”, “Key”, “Bus” and “Ext”.

Click the drop-down box of point trigger mode to select the desired type:

- Auto: The default mode. If the sweep mode is “continuous”, just select one sweep

type to start and sweep through each point continuously in one sweep cycle. If the sweep mode is “single”, first click **Execute single sweep** button to sweep through each point in one sweep cycle.

- Key: If the sweep mode is “continuous”, the device will sweep one point-at-a-time after every press of the **Trigger** button on the front panel or click **Click to trigger** button on the touch screen. If the sweep mode is “single”, you will need to click **Execute single sweep** button first, and then press the **Trigger** button once for every point in the sweep. The sweep will stop when finish one sweep cycle.
- Bus: If the sweep mode is “continuous”, the device will start a sweep after you send a “*TRG” command. If the sweep mode is “single”, you will need to click **Execute single sweep** button first and then send a “*TRG” command to start sweep a point. The sweep will stop when finish one sweep cycle.
- External: The device receives the trigger signal input from the **[TRIGGER IN]** connector on the back panel. If the sweep mode is “continuous”, the device will sweep one point when receiving a specified polarity TTL pulse. If the sweep mode is “single”, you will need to click the single sweep button first and then the device will start sweep one point when receiving a specified polarity TTL pulse. The sweep will stop when finish one sweep cycle.

2.3.8 Trigger Slope

When the trigger mode or the point trigger mode is “Ext”, you can select “Positive” or “Negative” as the trigger type. The default trigger type is “Positive”. Click the drop-down box to select the desired trigger edge:

- Positive: A sweep is triggered when the rising edge of the external trigger signal

arrives.

- Negative: A sweep is triggered when the falling edge of the external trigger signal arrives.

Note: The trigger edge control is displayed only when the trigger mode or point trigger mode is “Ext”, and is hidden in other cases.

When performing a sweep operation, the order of priority that satisfies the required conditions from high to low is: Single sweep -> trigger mode -> point trigger mode.

For example, when the “trigger mode “ and “point trigger mode” are both selected as “key”:

In the “continuous sweep”, first press the **Trigger** key to satisfy the trigger mode, and then press the **Trigger** key again to meet the point trigger sweep mode to begin sweep. In the “single sweep”, you need to press **Execute single sweep** first to meet the single sweep conditions, and then press the **Trigger** key two times to meet the sweep cycle trigger and point trigger conditions to begin sweep.

2.4 Modulation Setting

2.4.1 Amplitude Modulation (AM)

Amplitude Modulation (AM) is a technique for delivering information by linearly varying the amplitude of an RF carrier signal.

AM source can be selected as an internal source, external source or internal source + external source. To source dual tone level modulation, configure the source for internal source + external source. The internal source is shared with the LF. When the LF is turned on, the internal source can't be used as a modulation source.

Select **MOD**->**AM**, to enter the level modulation parameter setting state. The setting instructions are as follows:

Function Menu	Instructions
AM State	Turn on or off the level modulation function
AM Source	Select the modulation source, which can be Int, Ext, Int + Ext
AM Shape	Select modulation wave type
AM Rate	Frequency range: 0.01Hz~100kHz
AM Depth	Modulation depth range is from 0.01% to 100%
AM Sensitivity	Show the sensitivity of the external modulation source level to the modulation depth is 50%/V

2.4.1.1 AM State

Select **MOD**->**AM**-> **AM State**, and then turn on or off the level modulation.

2.4.1.2 AM Source

An internal and/or external source can be selected for amplitude modulation.

MOD->**AM**->**AM Source** to set “Int” or “Ext” or “Int + Ext”. The default is “Int”.

1. Int

when internal modulation is selected, the AM Shape, AM frequency, and AM depth are controlled by the instrument. The internal modulation setting uses the LF generator as the modulation signal source. When modulation is activated, the LF output will be disabled, if it was previously activated.

2. Ext

Use an externally applied modulation signal. The external signal is input via the **【EXT MOD INPUT】** connector on the rear panel of the instrument. The modulated signal can be an arbitrary waveform. At this time, the modulation depth is controlled by the level of the externally modulated signal, and the sensitivity of the external modulation source level to the modulation depth is 50%/V.

3. Int + Ext

Use both the internal and externally applied modulation signals, this technique can be used to source dual tone AM.

2.4.1.3 AM Shape

The SSG3000X supports modulation waveforms for internal “sine” and “square” modulation sources. Select **MOD**->**AM**->**AM Shape**, after setting to “Int” or “Int+Ext”, you can select AM waveform as “Sine” or “Square”.

2.4.1.4 AM Rate

Select **MOD**->**AM**-> **AM Rate**, and set the AM rate.

1. Sine wave modulation frequency range is 0.01Hz~100kHz
2. Square wave modulation frequency range is 0.01Hz~20kHz

2.4.1.5 AM Depth

Set the modulation depth in percent. Select **MOD**->**AM**->**AM Depth**, and then set AM depth.

When the “Int” modulation source is selected, the AM modulation depth is set from 0.01% to 100%. The relationship between the modulation depth m and the carrier sideband level difference ΔP is satisfied: $\Delta P = 6.02 - 20 \cdot \log(m)$

When the “Ext” modulation source is selected, the sensitivity of the external modulation source level amplitude to the modulation depth is 50%/V. For example, the modulation depth is 100% when the external modulation signal is 2Vpp (offset is 0V), and the modulation depth is 50% when the external modulation signal is 1Vpp (offset is 0V).

When selecting the “Int+Ext” modulation source, the modulation depth set is the internal source modulation depth + the external source modulation depth, and the internal source modulation depth is assigned = the external source modulation depth. For example, if the modulation depth is set to 100%, the modulation depth assigned to the internal source is 50%, the external source modulation depth is 50%, and the external modulation sensitivity is 25%/V. If the external modulation signal is 2Vpp (the offset is 0V), then the modulation depth is 100%.

2.4.2 Frequency Modulation (FM)

Enter the FM interface

1. Click the MOD icon in the main interface to enter the MOD interface. The MOD interface displays the AM page by default. Then switch to the FM modulation page by clicking or sliding left.
2. Enter the FM modulation page directly through the shortcut menu.
3. Enter the MOD interface via the **MOD** button and switch to the FM page.

2.4.2.1 FM State

Select **MOD** -> **FM**-> **FM State**, to turn FM on or off.

2.4.2.2 FM Source

Select **MOD** -> **FM**-> **FM Source** to set "Int" or "Ext" or "Int + Ext". The default is "Int".

1. Int

Use the internal LF generator as the modulation signal source for FM. The FM Shape, FM deviation, and FM rate can be set.

When LF and FM mod is **simultaneous** on, their frequency and shape is changed according to who was changed.

2. Ext

Use an externally applied modulation signal. The external signal is input via the MOD EXT connector with an impedance matching of 50 ohms and the amplitude is up to +-3V.

3. Int + Ext

Use both, the internal and externally applied modulation signal; this technique can be used to perform two-tone FM.

2.4.2.3 FM Shape

Select **MOD**->**FM**-> **FM Shape**. After setting to “Int” or “Int+Ext”, you can select FM waveform as “Sine” or “Square”.

2.4.2.4 FM Rate

Select **MOD**->**FM**-> **FM Rate**, you can set the FM rate.

1. The sine wave modulation frequency range is 0.01Hz~100kHz
2. The square wave modulation frequency range is 0.01Hz~20kHz

2.4.2.5 FM Deviation

Corresponding to different carrier frequencies, the frequency offset range may be different; the setting range is governed by the following equation: $0.01\text{Hz} \sim N \times 1\text{MHz}$. For the definition of N, refer to the data sheet.

- When the modulation source is set to “Int”, the set value is actually the frequency offset of the RF output.
- When the modulation source is set to “Ext”, it is related to the amplitude of the external input modulation signal. The offset of RF output = amplitude of input signal × external modulation sensitivity.
- When the modulation source selects “Int+Ext”, the set value is the maximum value of the total offset, the internal source accounts for 50%, and the external source accounts for 50%. RF output offset = set value × 0.5 + external input signal amplitude × external

modulation sensitivity.

External modulation sensitivity

The display shows the unit offset quantized by the amplitude of the externally modulated signal, which is equal to the maximum offset when the external modulation input is full scale. When the “Int+Ext” modulation source is enabled, the internal and external each account for 50% of the maximum offset, so when the external source inputs a full scale signal, it only accounts for 50% of the maximum output offset.

Note: The modulation function must be activated to modulate the output signal. You can turn it on or off by pressing the **MOD ON/OFF** button or you can open it by checking the MOD module on the home page, as shown in the figure:

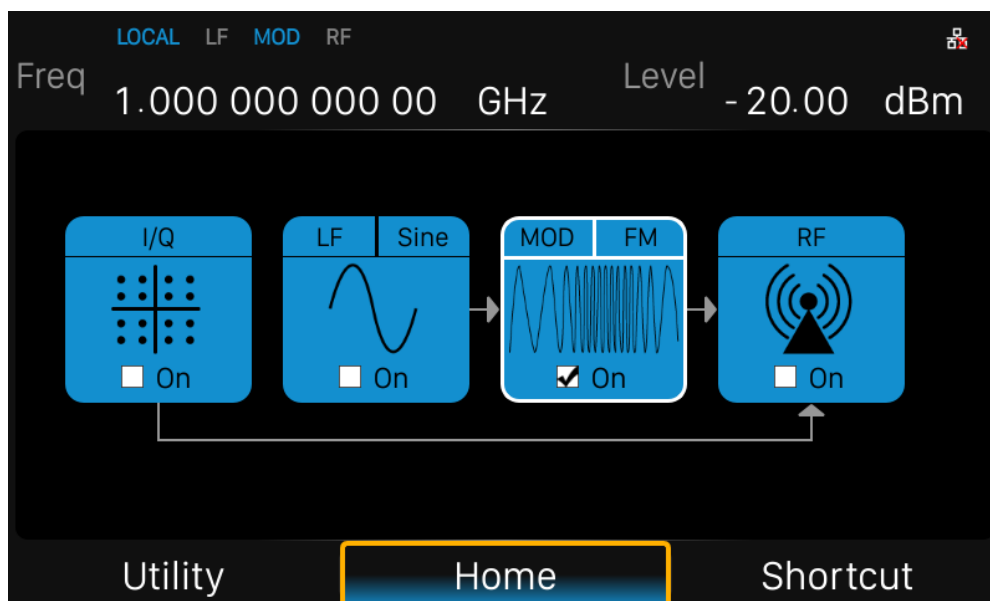

2.4.3 Phase Modulation (PM)

Enter the PM interface

1. Click the MOD icon in the main interface to enter the MOD interface. The MOD interface displays the PM page by default. You can switch to the PM modulation page by clicking or sliding left.

2. Enter the PM modulation page directly through the shortcut menu.
3. Enter the MOD interface via the **MOD** button and switch to the PM modulation page.

2.4.3.1 PM State

Select **MOD** -> **PM**-> **PM State** to turn PM on or off.

2.4.3.2 PM Source

Select **MOD** -> **PM**-> **PM Source** to set “Int” or “Ext” or “Int + Ext”. The default is “Int”.

1. Int

Use the internal LF generator as the modulation signal source for PM. The PM Shape, PM deviation, and PM rate can be set.

2. Ext

Use an externally applied modulation signal. The external signal is input via the EXT MOD INPUT connector with an impedance of 50 ohms

3. Int + Ext

Use both, the internal and externally applied modulation signal; this technique can be used to perform two-tone PM.

2.4.3.3 PM Shape

Select **MOD** -> **PM**-> **PMShape**. After setting the source to “Int” or “Int+Ext”, you can select PM waveform as “Sine” or “Square”.

2.4.3.4 PM Rate

Select **MOD** -> **PM**-> **PMRate**, then you can set the PM rate.

1. The sine wave modulation frequency range is 0.01Hz~100kHz

-
2. The square wave modulation frequency range is 0.01Hz~20kHz

2.4.3.5 PM Deviation

The setting range is $0.00001\text{rad} \sim N \times 5\text{rad}$. For the definition of N, refer to the data sheet.

- When the modulation source is set to “Int”, the set value is actually the frequency offset of the RF output.
- When the modulation source is set to “Ext”, it is related to the amplitude of the external input modulation signal. Offset of RF output = amplitude of input signal × external modulation sensitivity.
- When the modulation source selects “Int+Ext”, the set value is the maximum value of the total offset, the internal source accounts for 50%, and the external source accounts for 50%. RF output offset = set value × 0.5 + external input signal amplitude × external modulation sensitivity.

External modulation sensitivity

The display shows the unit offset quantized by the amplitude of the externally modulated signal, which is equal to the maximum offset when the external modulation input is full scale. When the “Int+Ext” modulation source is enabled, the internal and external each account for 50% of the maximum offset, so when the external source inputs a full scale signal, it only accounts for 50% of the maximum output offset.

Note: The modulation function must be activated to modulate the output signal. You can turn it on or off by pressing the **MOD ON/OFF** button or you can open it by checking the MOD module on the home page, as shown in the figure:

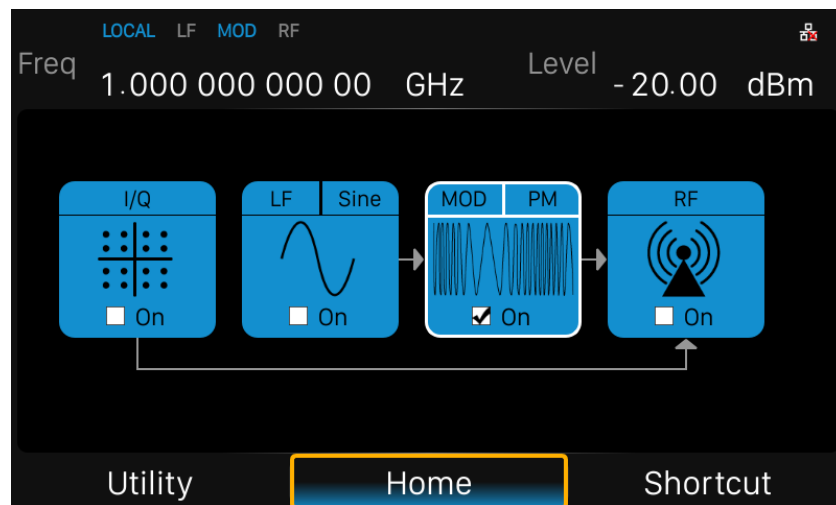

2.4.4 Pulse Modulation (PULSE)

Pulse Modulation represents the process of modulating an RF carrier signal with a pulse signal as a modulated signal.

2.4.4.1 Pulse State

Select **MOD**->**PULSE**->**Pulse State** to turn Pulse on or off.

2.4.4.2 Pulse Out

Select **MOD**->**PULSE**->**Pulse Out** to turn Pulse Out on or off. The default is off.

- On: Turn on the pulse output function. At this time, the signal source outputs the pulse signal generated by the internal pulse generator from the **[PULSE IN/OUT]** connector on the rear panel.
- Off: Turn off the pulse output function.

Notes: When the modulation source is “Ext”, the pulse output function will be turned off automatically.

2.4.4.3 Pulse Source

Select **MOD**->**PULSE**->**Pulse Source** to set “Int” or “Ext”. The default is “Int”.

1. Int

Use the internal LF generator as the modulation signal source for PM. You can set Pulse Mode, Pulse Period, and Pulse Width and so on.

2. Ext

Use an externally applied modulation signal. The external signal is input via the **[PULSE IN/OUT]** connector.

At this time, setting items such as pulse type, pulse period, pulse width, trigger mode, and pulse output are hidden.

2.4.4.4 Pulse Polarity

The default is “Normal”. Click the drop down box to switch the pulse polarity type

- Normal: Perform pulse modulation when the pulse modulation signal is high.
- Inverse: Do not perform pulse modulation when the pulse modulation signal is high.

2.4.4.5 Pulse Mode

When the modulation source is “Int”, the SSG3000X provides three pulse modes: “Single”, “Double” and “Train”. The default is “Single”. Click the drop down box to select the pulse mode.

- Single: A pulse signal is generated during one pulse period. At this time, the two settings “Double Pulse Delay” and “#2 Width” are hidden.

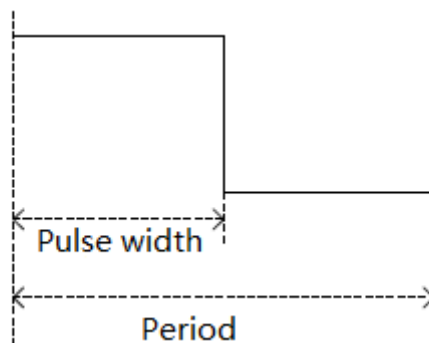

- Double: Generate two pulse signals in one pulse period. At this time, the two settings “Double Pulse Delay” and “#2 Width” are shown.

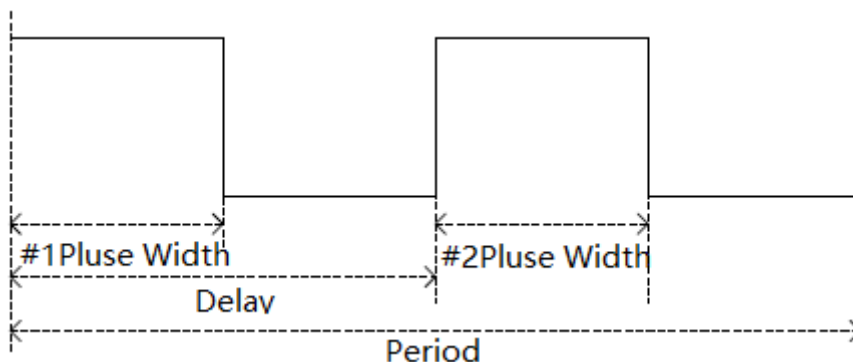

- Train: Multiple pulse signals in one pulse period. At this time, the pulse sequence setting item appears, and the two settings “Double Pulse Delay” and “#2 Width” are hidden.

Note: This setting item will be hidden when the modulation source is “Ext”.

2.4.4.6 Pulse Period

The pulse period represents the time interval between two adjacent periodic pulses, and the period of the single pulse or double pulse modulated signal can be set by touching the screen keyboard or pressing the front panel keypad.

Note: This setting item will be hidden when the modulation source is “Ext” or the pulse

mode is “Single” or “Double”.

2.4.4.7 Pulse Width

The pulse width indicates the duration when the pulse signal is at a high level. The width of the first pulse of the single pulse modulated signal or the double pulse modulated signal can be set by touching screen keyboard or pressing the front panel keypad.

Note: This setting item will be hidden when the modulation source is “Ext” or the pulse mode is “Train”.

2.4.4.8 Double Pulse Delay

The double pulse delay indicates the delay from the start of the first pulse to the start of the second pulse in a single cycle of the double pulse modulated signal. This parameter can be set by touching screen keyboard or pressing the front panel keypad.

Note: This setting item will be hidden when the modulation source is “Ext” or the pulse mode is “Train”.

2.4.4.9 #2 Pulse Width

#2 Pulse Width represents the width of the second pulse of the double pulse modulated signal. This parameter can be set by touching screen keyboard or pressing the front panel keypad.

Note: This setting item will be hidden when the modulation source is “Ext” or the pulse mode is “Train”.

2.4.4.10 Trigger Out

The default is “off”, Click the slide switch to switch the trigger output switch status.

- On: Turn on the trigger output function. At this time, the signal source outputs the trigger signal generated by the internal pulse generator from the **[TRIG IN/OUT]** connector on the rear panel.

- Off: Turn off the trigger output function.

Note: When the trigger mode is “Ext Trig” or “Ext Gate”, the trigger output function will be automatically turned off. And only the trigger signal of the PULSE modulation signal is output, and the trigger signals of the LF SWEEP and the RF SWEEP are not output.

2.4.4.11 Pulse Trigger

The trigger mode defaults to “Auto”. The SSG3000X offers four pulse trigger types: “Auto”, “Key”, “Ext Trig” and “Ext Gate”.

Click the drop-down box corresponding to the trigger mode to select the desired type.

- Auto: The default trigger method. The signal source satisfies the trigger condition at any time. At this time, the two settings “TrigSlope” and “Trig Polarity” are hidden.

- Key: Each time the “Trigger” key is pressed, the signal source initiates a pulse modulation. At this time, the two settings “TrigSlope” and “Trig Polarity” are hidden.

- Ext Trig: The source receives the trigger signal from the **[PULSE IN/OUT]** connector on the rear panel. Each time a TTL pulse signal of the specified polarity is received, the source initiates a pulse modulation. At this point, the “Trig Slope” setting will be displayed and the “Trig Polarity” setting will be hidden.

- Ext Gate: The source receives the trigger signal from the **[PULSE IN/OUT]** connector

on the rear panel. Each time a TTL pulse signal of the specified polarity is received, the source initiates a pulse modulation within its active level. At this point, the “Trig Polarity” setting will be displayed and the “Trig Slope” setting will be hidden.

2.4.4.12 Trigger Delay

The trigger delay indicates the delay from the receipt of the external trigger signal to the start of the first pulse. This parameter can be set by touching screen keyboard or pressing the front panel keypad.

Note: This setting item will be hidden when the modulation source is “Ext” or the pulse trigger is not “Ext Trig”.

2.4.4.13 Trigger Slope

The default is “Positive”, click the drop-down box to switch the trigger slope.

- Positive: Trigger a pulse when the positive slope of the external trigger signal arrives.
- Negative: Trigger a pulse when the negative slope of the external trigger signal arrives.

Note: This setting item will be hidden when the modulation source is “Ext” or the pulse trigger is not “Ext Trig”.

2.4.4.14 Trigger Polarity

The default is “Normal”; click the drop-down box to switch the trigger polarity type.

- Normal: Trigger a pulse modulation during the effective time when the external gate signal is high.

- Inverse: Trigger a pulse modulation during the effective time when the external gate signal is not high.

Note: This setting item will be hidden when the modulation source is “Ext” or the pulse trigger is not “Ext Gate”.



2.4.4.15 Pulse Train



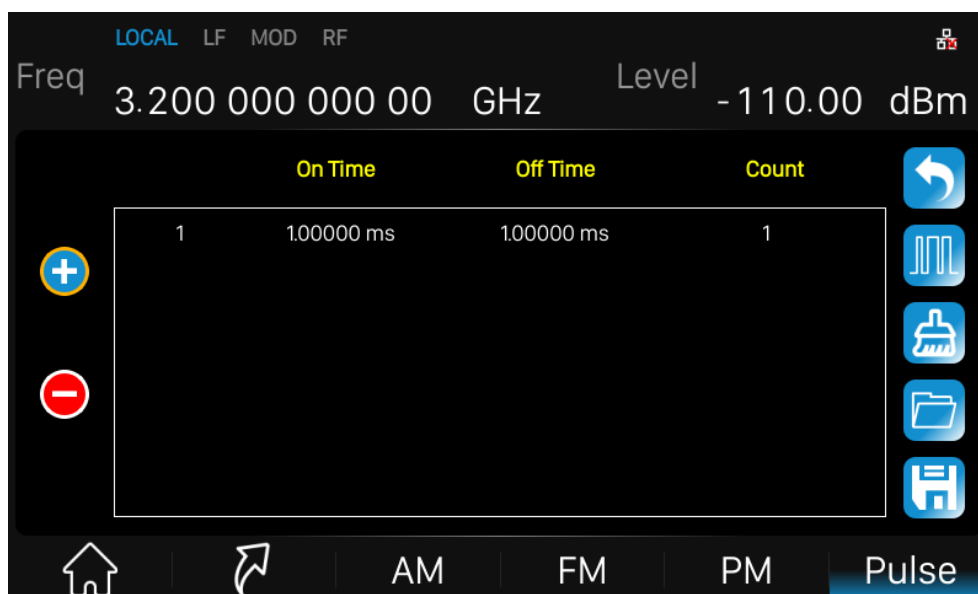

When the Pulse Mode is set to Train, the Pulse Train option appears.

Click Pulse Train to enter the table edit page for the pulse sequence.



As shown, the list edit page consists of the left action button, the middle table area, and the right menu button:

- 1) Insert line: Click the button  to automatically insert a new line on the next line where the current cursor is located.
- 2) Delete line: Click the button  to delete the line where the current cursor is located.
- 3) Parameter editing: Click each parameter in the table area and set it through the touch screen keyboard or the front panel keypad.

-
- 4) Return to the previous level: Click the  button to return to the previous menu.
 - 5) Clear list: Click the  button to clear and reset the current list.
 - 6) View the pulse sequence diagram: Click the  button to enter the pulse sequence diagram page.
 - 7) Load list: Click the  button to enter the file system directory. At this time, you can select and read the scan list file previously saved in the device, and you can edit and modify the next step.
 - 8) Save the list: Click the  button to enter the file system directory. At this time, you need to enter the file name to save the scan list file.

Note: For details on loading/saving files, please refer to the related introduction in “File Management”.

The parameters in each row represent the settings for each pulse signal in a single pulse period:



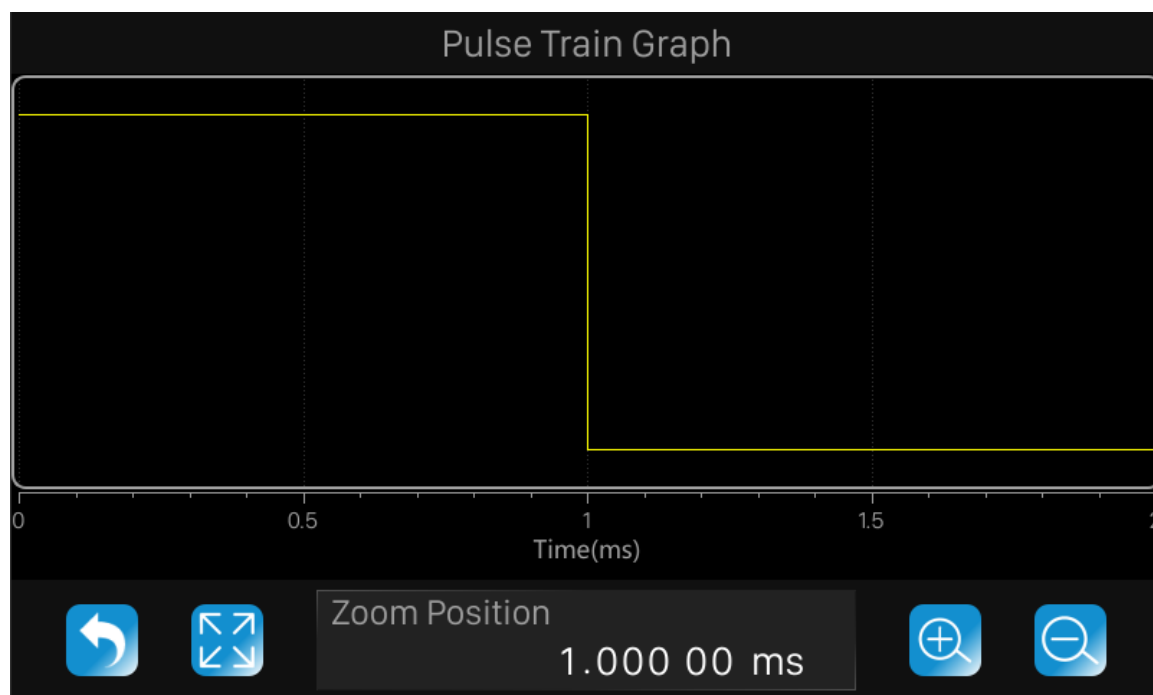

- 1) Serial number: indicates the serial number of the pulse signal corresponding to this line.
- 2) Positive pulse time: Indicates the duration of the pulse signal being high.
- 3) Negative pulse time: Indicates the duration of the pulse signal being low.
- 4) Quantity: Indicates the number of repetitions of this pulse signal.

The pulse sequence schematic page is shown below:





As shown, the page consists of the upper drawing area and the lower control area:

1) Plot area: A schematic diagram of the waveform generated from the data entered in the current pulse sequence table. The vertical direction represents the high and low level changes of each pulse signal in the pulse sequence, and the position of the high and low levels in the direction is unchanged; The horizontal direction represents the high and low level duration of each pulse signal in the pulse sequence. You can use the zoom feature to observe different details of the waveform.

2) Control area: Click the  button to return to the previous pulse sequence table edit page; Click the  button to restore the waveform to the initial state; Click the  button to view the current waveform center position. Zoom in; Click the  button to zoom out the center position of the current waveform; The “Zoom Position” parameter control displays the center position of the current waveform, and the operations of the “Zoom In” and “Zoom Out” buttons are based on this position. It can be set by touching screen keyboard or pressing the front panel keypad to shift the current waveform to the corresponding position.

The scaling operation for the drawing area can be achieved in the following ways:

- Zoom in, zoom out, restore and pan through the Control Area's , , , and Zoom Position parameter controls.
- From the web interface, you can press the left mouse button, select the area to be enlarged, and then release the left button to complete the zoom operation. You can also use the finger or touch directly to zoom in on the touch screen; click the right mouse button to undo the previous step.
- From the web interface, you can use the mouse wheel, roll down to zoom in and roll up to zoom out. The zoom position of the wheel is the same as the zoom position of the control area.

2.5 LF Setting

2.5.1 LF Source

The SSG3000X has an internal low-frequency signal generator that can be used as an internal source for low-frequency signal output or analog modulation. When output as a low-frequency signal, the LF output supports several common waveforms, and the frequency and amplitude of the low-frequency signal can be set. Press **LF** to enter the LF parameter settings. Setting description is as follows:

2.5.1.1 LF State

Select **LF** -> **LF Source** -> **LF State** to turn LF on or off.

2.5.1.2 LF Frequency

Select the **LF** -> **LF Source** -> **LF Frequency** to set the frequency of the LF output signal, the setting range is 0.01Hz ~ 1MHz.

2.5.1.3 LF Level

Select the **LF** -> **LF Source** -> **LF Level** to set the LF output amplitude, the range is from 1mV ~ 3V, and supports a number of unit types.

2.5.1.4 LF Offset

Select **LF** -> **LF Source** -> **LF Offset** to set the amplitude offset of the LF output. The

setting range is. $|LF_{offset}| \leq 2.5 - \frac{1}{2} LEVEL$

2.5.1.5 LF Shape

Select **LF**-> **LF Source**->**LF Shape**, you can select the LF output signal waveform. Current waveform types are “sine wave”, “square wave”, “Sawtooth wave”, “triangle wave”, and “DC”. The default LF output signal is the “sine wave” waveform.LF phase

2.5.1.6 LF Phase

Select the **LF**-> **LF Source** ->**LF Phase** you can set the LF phase, the setting range is -360° ~ 360°, and supports degrees or radian units.

2.5.2 LF Sweep

2.5.2.1 Sweep State

Select **LF**->**LF Sweep**->**Sweep State** to activate the LF frequency sweep signal generation.

2.5.2.2 Start Freq

Select **LF**->**LF Sweep** ->**Start Freq** to set the start frequency.

2.5.2.3 Stop Freq

Select **LF**->**LF Sweep** ->**Stop Freq**. to set the stop frequency.

2.5.2.4 Center Freq

Select **LF**->**LF Sweep**->**Center Freq** to set the center frequency.

2.5.2.5 Freq Span

Select **LF**->**LF Sweep** ->**Freq Span** to set the frequency Span.

2.5.2.6 Direction

Select **LF**-> **LF Sweep** ->**Sweep Direction**. to set the sweep direction.

2.5.2.7 Sweep Times

Select **LF**->**LF Sweep** ->**Sweep Time** to define the duration of the individual sweep steps.

The “Dwell Time” set by the user is used as the step time of the sweep.

2.5.2.8 Trigger Mode

Select **LF**->**LF Sweep**->**Trigger Mode** to select the LF frequency sweep mode. If you change the sweep mode during the execution, the signal generator stops the sweep and starts with the next trigger event at the initial value.

1. Auto

Generate a continuously repeating sweep signal immediately after activating the sweep mode.

2. Key

Generate a single sweep cycle after a trigger event. The sweep steps within the cycle are performed automatically, controlled by the dwell time. If one cycle is completed, the

instrument waits for the next trigger event.

3. Ext

Generate a single sweep cycle when an external trigger event occurs.

2.5.2.9 Sweep Shape

Select **LF**->**LF Sweep**->**Sweep Shape** to select the waveform shape of the sweep signal.

1. Sawtooth

The sweep runs from the start to the stop frequency. Each subsequent sweep starts at the start frequency that means the shape of the sweep sequence resembling a Sawtooth.

2. Triangle

The sweep runs from start to stop frequency and back, that means the shape of the sweep resembles a triangle. Subsequent sweep starts at the initial start frequency.

2.5.2.10 Sweep Space

Select **LF**->**LF Sweep**->**Sweep Space** to select the mode for the calculation of the frequency sweep intervals.

1. Linear

Take the frequency value entered as an absolute value in Hz

2. Logarithmic

Takes the value entered as a logarithmic value that means as a constant fraction of current frequency in %.

2.6 Utility

2.6.1 System

2.6.1.1 Setting

1. Language

Set the display language of SSG3000X. SSG3000X supports Chinese/English menus, help and interface display.

Press **UTILITY**->**Setting**->**Language** to expand drop down list, and then select the desired language.

2. Power On

Set the type of parameter configuration to be loaded when the instrument startup.

Press **UTILITY**->**Setting** ->**PowerOn** to expand drop down list, and then select “Default” or “Last”.

Default: The factory defined default settings will be loaded at power on. For more details please refer to Table 2-3.

Last: The system setting before the last power-off will be loaded automatically at power-on.

3. Preset Type

Set the parameters for the Preset configuration of the instrument.

Press **UTILITY**->**Setting**->**Preset Type** to expand drop down list, and then select “Default” or “User”

- Default: The default settings will be loaded when **PRESET** is pressed. For more details please refer to Table 2-3.

- User: The user specified configuration will be loaded when **PRESET** is pressed. After “User” is selected, click  button to load the configuration file. For detailed operation procedure please refer to “Store/Recall”

4. Factory Default

Restore the instrument configuration to factory settings.

Press **UTILITY**->**Settings**->**Set to factory defaults**, set the instrument parameters and status to factory defaults.

Restore factory settings. In addition to loading the default settings, the following functions and parameters will be configured.

Table 2-2 Factory default

Parameter	Default
Setting	
Language	Chinese/English(depend on factory config)
Preset	Default
Beeper	On
Screen Saver	Off
Power On	Off
Interface	
DHCP State	Off
IP Address	10.11.13.220
Subnet Mask	255.255.255.0
Gateway	10.11.13.1
GPIB Address	18
Level	

SIGLENT

Flatness	null
Sweep	
List sweep	Keep only one default scan point
Mode	
Pulse Train	Keep only one default pulse

5. Beeper

Set whether the beeper make a sound when clicking any button, input box or check box.

Press **UTILITY**->**Setting** ->**Beeper** to switch the beeper state.

6. Screen Saver

Set the state of screen saver. When screen saver is switched on, screen saver will be enabled if no action is taken within the specified time. Click the touch screen or press any key to resume.

Press **UTILITY**->**Setting**->**Screen Saver**to expand drop down list, and then select “off”, “10 s”, “1 min”, “5 min”, “15 min”, “30 min”, “1 hour” or “2 hour”

7. Power On Line

Set the instrument power on sequence. In some situations, you may want the instrument to automatically restart if the line power is restored.

- Off: If line power is available, you need to manually press the power key on the front panel to start the instrument.
- On: If line power is available, the instrument starts automatically. This is an idea feature for automatic or remote tests that may be difficult to physically reach.

Press **UTILITY**->**Setting** ->**Power on Line** to switch the state

8. Time Setting

Set the display time of the instrument.

Press **UTILITY**->**Setting** ->**Time Setting**, then move the cursor to specified location and change the time by inputting the value.

2.6.1.2 System Info

Press **UTILITY**->**System Info** to view the instrument's system information, including:

- Startup Times
- Model
- Software Version
- Hardware Version
- Host ID
- Serial Number

2.6.1.3 Interface

Press **Utility** ->**Interface** to view the instrument's remote control interface information, including:

1. LAN Setting

1) DHCP

Set the state of DHCP.

Press **UTILITY**->**Interface** ->**DHCP State**, then press **ENTER** or knob to change the state.

When the DHCP state is on, the network DHCP server will configure the IP address, subnet mask and gateway automatically according to the current network condition.

When the DHCP state is off, the IP address, subnet mask and gateway will be configured by the user.

SIGLENT

2) IP Address

Configure the network IP address.

Press **UTILITY**->**Interface** ->**IP Address**, then move the cursor to specified location and press number keys to input value, finally press **ENTER** to make the setup effective.

3) Subnet Mask

Configure the network subnet mask.

Press **UTILITY**->**Interface** ->**Subnet Mask**, then move the cursor to specified location and press number keys to input value, finally press **ENTER** to make the setup effective.

4) Gateway

Configure the network subnet mask.

Press **UTILITY**->**Interface** ->**Gateway**, then move the cursor to specified location and press number keys to input value, finally press **ENTER** to make the setup effective.

2. Web Setting

Set the web login password.

Press **UTILITY**->**Interface** ->**Web PasswordSetting**, to enter the current password. After correctly entering the password, a new password can be set in New Password. Then make the setup effective by entering the new password again in Confirm Password. If the password needs to be reset to default, just click the Reset to default button. (The default password is "siglent".)

3. GPIB Setting

Set the GPIB address from 1 to 30. SSG3000X must use the SIGLENT USB-GPIB interface (optional) connected to the USB Host port located on the rear panel.

Press **UTILITY**->**Interface** ->**GPIB Address**, and then press number keys to input value,

finally press **ENTER** to make the setup effective.

2.6.1.4 Self Test

1. Press **UTILITY** -> **Self test** to enter the self test menu, including:LCD Test

SSG3000X cycles through the red, green and blue pixels of the display to verify whether there are dot defects on the screen.

Press **UTILITY**->**Self-Test** ->**LCD Test**, then press **7** to change the color and press **8** to exit.

2. Key Test

Press **UTILITY**->**Self-Test** ->**Key Test**, to enter the keyboard test interface. Press the function keys at the front panel one by one and observe whether the corresponding key is checked. If not, an error may have occurred in that key. To exit the test, press **8** three times or click the screen.

3. LED Test

Press **UTILITY**->**Self-Test** ->**LED Test**, to enter the LED test interface. Press **7** to light or extinguish the key light of the button **MODON/OFF** and **RFON/OFF** and press **8** to exit the test.

4. Board Test

Press **UTILITY**->**Self-Test** ->**LEDTest**, to enter the board test interface. Test whether writing and reading are normal for CPLD and FPGA.

5. Touch Screen Test

Press **UTILITY**->**Self-Test** ->**TouchScreenTest**, to enter the touch screen test interface. Click the marks on the interface to test the touch screen and press **8** to exit the test.

2.6.1.5 Shutdown

Press **UTILITY**->**Shutdown** to power off the instrument according to operating hints on the interface.

2.6.1.6 Preset

Reset parameter settings according to the type of preset selected.

Press **UTILITY**->**Preset**, to reset the parameters.

2.6.1.7 Update

Press **UTILITY**->**Update**, and select the update file. Then click **Recall** to update the system software. The progress bar will appear on the screen while updating and the instrument will restart automatically if updates succeed or pop-up prompt box if updates fail.

2.6.1.8 Option



Press **Utility** ->**Option**, to enter the option interface. Click the drop-down box under the "Install" to choose the license type that you wish to install. Then, click on the text field below the install type and use the touchscreen keypad to enter the license information. Click **Install** to finish the license installing.

If the installations succeed, the prompt message "license was successfully installed" will be pop-up. If not, the prompt message "license was entered incorrectly" will be displayed.

Note: The SSG comes with trial time for available options. The remaining number of trial use is displayed for each option at top of the option interface. When the remaining time of a certain function is zero, the function will be disabled. When a license is successfully

installed for a certain function, the remaining times will be shown as "--" and the type of the license is permanent, which means users have unrestricted access to the function.

2.6.1.9 Help

Press **UTILITY**->**Help**, to enter help interface and select the help items you need to view. You can jump to the related page by clicking underline texts, return to the help list by clicking the icon , return to the last page by clicking the icon . And after returning to last page, you can return to the original page by clicking the icon .

2.6.1.10 Contact Us

Press **UTILITY**->**Contact Us** to view the contact information for SIGLENT. You can contact us to solve the problems meet in practical use. You can also write info@siglent.com or call your local SIGLENT sales office for support.

2.6.2 Store/Recall

Press **UTILITY**->**Store/Recall** to enter file management page. Then you can select file by knob and fold or expand folders by left and right direction key.

1. View Type

Click **ViewType** to change the type of files to show, including "All", "Data", "State" and "Update".

1) Data file:

- .lsw file: Sweep list data file;
- .uft file: Flatness correction file;
- .pulstrn file: Pulse train file.

2) State file:

- .xml file: State saving file.

3) Update file:

- .CFG file: Configuration update file;
- .ADS file: System update file.

2. New Dir

Click **NewDir** to create new folders. Press  to switch the case of letter when entering the name of a new file.

3. Rename

Click **Rename** to rename a file or folder.

4. Delete

Click **Delete** to delete the selected file.

5. Copy

Click **Copy** to copy the selected file or folder.

6. Paste

Click **Paste** to paste the copied file or folder to specified location.

7. Recall

Click **Recall** to load the selected file.

8. Save

Click **Save** to save the file with corresponding type according to the type of data.

2.7 Power Sensor

The SSG3000X can be connected to a USB power sensor via the USB Host interface. For the first connection, please refer to the “Option” to activate the power meter software. Then, connect the USB power sensor to the USB Host connector on the rear panel. If the “Power sensor has been connected!” message pops up on the screen, the signal source has successfully activated the power meter control option, and you can always use the power sensor function.

The power sensors currently supported by the SSG3000X are shown in the following table:

Manufacturer	Model
R&S (Rohde and Schwarz)	NRP6A USB Power Sensor
Keysight	U2000A Series USB Power Sensor

2.7.1 Power meter setting

The power sensor menu can be accessed in one of three ways:

- ◆ Click the power meter button on the shortcut menu.
- ◆ Click on the power meter measurement control on the home page.
- ◆ Switch menus by clicking the menu button or swiping in the Frequency, Level, or Sweep menu.

2.7.1.1 Sensor Info

Indicate the type of a connected power sensor. The sensor type is automatically detected.

2.7.1.2 Sensor State

The default is “off”. Activate/deactivate level measurement by the power sensor.

- On: Turn on the power sensor measurement function, and the measurement control refreshes the power sensor measurement value in real time.
- Off: Turn off the power sensor measurement function.

2.7.1.3 Measurement

Indicate the current reading of the sensor.

Select the unit used for result display. You can change the unit for the result display: dBm, dB μ V, μ V, mV, V, nW, μ W, mW, W.

2.7.1.4 Level Control

With the Level Control function, you can achieve very stable and accurate RF power your DUT. With the aid of a downstream control circuit, a CLPC (Closed Loop Power Control), you can detect frequency response characteristics of the components: such as losses due to cables, modules or components and compensate these effects accordingly.

2.7.1.5 Statistics

The default is “off”. When activated, statistics indicate the measured mean, maximum, minimum and the count of each measurement...

- On: Turn on the statistics function. Each statistical parameter is displayed on the parameter bar. Statistical parameters include average, minimum, maximum, and statistics. Click the “Clear” button to clear all current statistics and start new statistics.
- Off: Turn off statistics. Statistical parameters will be hidden

2.7.1.6 Auto Zero

When the power meter is zeroed, the zero measurement deviation and noise influence can be reduced, and the accuracy of the RF power measurement can be improved.

- **Disable:** The zero buttons will be hidden.
- **Internal Zeroing:** In this way, the power sensor remains connected to the RF signal during the zeroing process. Zero buttons is displayed.
- **External Zeroing:** When this mode is selected, you must remove the RF signal to be measured before the power sensor can be zeroed. Otherwise it will affect the zeroing result. Zero buttons is displayed.

Press the “Click to perform zeroing” button, and the instrument performs the zero calibration operation of the power meter according to the “zero calibration type” you selected. This feature can be used to reduce the effects of noise and zero offset on the measurement results. And the button name will change from “Click to perform zeroing” to “Zero In Progress...” After the zero adjustment is completed, the button name will be restored to the word “Click to perform zeroing”.

Note: If the power meter does not have an internal or external zeroing option, the “internal” and “external” in the drop-down boxes are replaced by the “Enable” option.

2.7.1.7 Measure Frequency

The default is “Auto”. Click the drop down box to switch the mode.

- **Auto:** In this mode, the instrument configures the frequency value based on the output frequency of the RF.
- **Manual:** In this mode, the measurement frequency can be set by the touch screen keyboard or the front panel keypad.

2.7.1.8 Level Offset

The default is “Off”. Click the slide switch to switch the power offset switch status.

- On: The values can be set by the touch screen keyboard or front panel keypad. The displayed value will be the actual measurement plus the offset. This feature makes measurements easier when there are amplifiers and attenuators in the middle of the signal chain.
- Off: The display is consistent with the actual reading of the power sensor.

2.7.1.9 Averaging Mode

The default is “Auto”. Click the slide switch to switch the averaging mode.

- Auto: Automatically configure the average number of times based on the current parameters. Fixed noise parameter settings will be automatically hidden.
- Manual: Manually set the average number times, with the parameter are behind.
- Fixed Noise: The power sensor will control the internal noise that does not exceed the set value of the fixed noise parameter. Fixed noise parameter settings will be displayed. It can be set by the touch screen keyboard or the front panel keypad.

Note: If the power sensor does not have a “fixed noise” mode, this option will not be displayed in the drop down box.

2.7.1.10 Logging

The default is “Off”. Click the slide switch to switch the logging.

- On: The source will record the measurements and save it in a log file.
- Off: The signal source does not record the measurements.

2.7.2 Level Control



As shown in the example, the sensor measures a proportional power in defined time intervals, derived from a coupler. It considers optionally the given S-parameters and returns the results to the generator. The signal generator compares the measured level with the set value and adjusts its output level accordingly. This allows you to control the external signal level continuously and reliably reach a constant input level at the DUT in real time.

In practice, an RF splitter is needed to split the RF signal. One of them is connected to the DUT and the other is connected to the power meter. The signal source is for acquisition and compensation. Power compensation can be used to minimize cable losses, the attenuation of passive networks, and the amplification of the signal by a power amplifier and the frequency response of each device in the link as the frequency changes.

Note: When the function is turned on, the frequency or level sweep and the power sensor measurement function will be turned off, and vice versa.

2.7.2.1 SensorState

The default is “off”. Activate/deactivate level measurement by the power sensor.

- On: Turn on the power sensor level control function, and the measurement control refreshes the power sensor measurement value in real time.
- Off: Turn off the power sensor measurement function.

2.7.2.2 Measurement

Indicate the current reading of the sensor. Select the unit used for result display. You can change the unit for the results display: dBm, dB μ V, uV, mV, V, nW, uW, mW, W.

2.7.2.3 Target Level

Specify the nominal level expected at the input of the sensor. The signal generator adjusts the output power accordingly, in order to meet the target value at the sensor input, and thus the power required at the DUT.

The value can be set by the touch screen keyboard or the front panel keypad.

2.7.2.4 Level Limit

Set an upper limit for the RF output power to protect your DUT from damage due to high input power. If the input RF signal power exceeds the limit, the set value will not take effect and the source will pop up a warning message.

2.7.2.5 Capture Range

The capture range means that if the power sensor reading is within the effective capture range, it is a valid reading and the RF signal is adjusted and compensated. Set the capture range of the control system. If the power sensor reading exceeds this range, the reading will be ignored.

Effective Capture Range = Target Level +/- Catch Range

2.8 I/Q Modulation

I/Q modulation, i.e. two orthogonal signals (carriers with the same frequency, phase difference of 90°, generally expressed by Sin and Cos) and I (In-Phase, in-phase component) and Q (Quadrature Phase) signals are respectively modulated by carrier and transmitted together, thereby improving spectrum utilization.

Note: Only some models are equipped with IQ modulation function. For specific models, please refer to the SSG3000X data sheet.

2.8.1 Turning on I/Q modulation

The I/Q modulation setup menu can be accessed in one of three ways:

- Click the Power Meter button on the shortcut menu page.
- Click the I/Q modulation control on the home page.
- Press the **I/Q** button on the front panel.

On the I/Q modulation interface, click on the I/Q status to turn on I/Q modulation.

2.8.2 I/Q source

The I/Q modulation uses an external modulation source that receives the I/Q modulated in-phase baseband signals and quadrature phase modulation signals input from the **[I INPUT]** and **[Q INPUT]** connectors on the rear panel.

Note: The modulation function must be activated to modulate the output signal. You can turn it on or off by pressing the **MOD ON/OFF** button or you can open it by checking the MOD module on the home page.

2.9 Shortcut Keys

2.9.1 Preset

Recall the preset setting and restore the signal generator to a specified status.

- Press **UTILITY**->**Setting** ->**Preset Type** to select “Default” or “User”.
- Press **PRESET** to load the factory settings listed in the following table or User-defined settings.

Table 2-3 Default setting

Parameter	Default
RF	
RF State	Off
Frequency	
Frequency	3.2GHz
Freq Offset	0Hz
Phase Offset	0deg
Level	
Level	-110dBm
Level Offset	0dB
ALC State	Auto
Flatness	Off
Sweep	
Sweep State	Off
Sweep Mode	Continuous
Direction	Up
Trigger Mode	Auto
Point Trigger	Auto
Trigger Slope	Positive

SIGLENT

Step Sweep	
Step Sweep State	On
Start Freq	3.2 GHz
Stop Freq	3.2 GHz
Start Level	-110dBm
Stop Level	-110dBm
Sweep Points	11
Dwell Time	30ms
Sweep Space	Linear
Sweep Shape	Sawtooth
List Sweep	
List Sweep State	Off
MOD	
MOD State	Off
AM	
AM State	Off
AM Source	Int
AM Shape	Sine
AM Rate	1kHz
AM Depth	50%
FM	
FM State	Off
FM Source	Int
FM Shape	Sine
FM Deviation	100kHz
FM Rate	10kHz
PM	

PM State	Off
PM Source	Int
PM Shape	Sine
PM Rate	10kHz
PM Deviation	1rad
Pulse	
Pulse State	Off
Pulse Source	Int
Pulse Mode	Single
Pulse Period	10ms
Pulse Width	2ms
Double Pulse Delay	4ms
#2 Width	2ms
Trigger Out	On
Pulse Trigger	Auto
Trig Delay	140 ns
Trig Slop	Positive
Pulse Polarity	Normal
Pulse Out	Off
Trig Polarity	Normal
Pulse Train	Off
LF	
LF State	Off
LF Shape	Sine
LF Frequency	1kHz
LF Level	500mV
LF Offset	0uV

LF Phase	0deg
LF Sweep	
Sweep State	Off
Start Freq	500Hz
Stop Freq	1.5kHz
Center Freq	1kHz
Freq Span	1kHz
Sweep Time	1s
Trigger Mode	Auto
Sweep Shape	Sawtooth
Trigger Mode	Linear
Direction	Up

2.9.2 Home

Return to the home page.

2.9.3 Trigger

When the trigger mode of the sweep is key trigger, press this key once to trigger a sweep.

When the trigger mode of the pulse is key trigger, press this key once to start a pulse modulation.

When the trigger mode of the LF sweep is key trigger, press this key once to trigger a LF sweep.

2.9.4 Esc/Close

Switch off the instrument from remote control to manual control.

Quit the edit mode, if the edit mode is active.

In dialog boxes that contain an “Esc” button it closes the dialog box.

Exit the current menu and return to the previous menu.

2.9.5 Mod ON/OFF

Enable/disable modulation on the RF output. When enabled, the backlight will light, the screen status bar MOD will change from gray to blue, and RF output modulation will be activated. Press this button again to disable modulation. When disabled, the backlight is off, all modulation is off, and the user interface status bar MOD changes from blue to gray.

2.9.6 RF ON/OFF

Enabled or Disable the RF output. When enabled, the backlight will light, the screen status bar RF will change from gray to blue, and the RF output will be enabled. Press this button again to disable modulation. When disabled, the backlight is off, RF output is off, and the user interface status bar RF changes from blue to gray.

Chapter 3 Application Examples

3.1 Output RF signal

Output a RF signal with a frequency of 3GHz and amplitude of 0dBm from the RF OUTPUT 50 connector.

1. Restore factory settings

A) Press **UTILITY** or the touch screen to set **System** -> **Setting** -> **Preset Type**-> **Default**.

B) Press **PRESET**, or reset the system settings to perform reset operations. Make the frequency offset and the phase defaults 0.

2. Frequency setting

Press **FREQ**, and enter the 3GHz with the numeric keypad, or click the frequency on the touch screen to pop up the keypad to input 3GHz.

3. Level setting

Press **LEVEL**, and enter the 0dBm with the numeric keypad, or click the amplitude on the touch screen to pop up the keypad to input 0dBm on the keypad.

4. RF output

Press **RF ON/OFF** or press the **HOME** key back to the main interface, select the RF block, the white square on the left of ON to enable RF output. When enabled, the **RF ON/OFF** key backlight turns green and the RF state in the status bar changes to blue.

3.2 Output a modulated signal

In this section, we will show how to enable modulation by configuring the SSG to output an AM modulated signal with the following characteristics: Carrier frequency is 1GHz, the carrier amplitude is -10dBm, the AM modulation depth is 80%, the modulation frequency is 10 kHz, and the modulation waveform is a sine wave.

1. Restore factory settings

A) Press **UTILITY** or the touch screen to set **System** -> **Setting** -> **Preset Type**-> **Default**.

B) Press **PRESET** or reset the system settings to perform reset operations. Make the frequency offset and the phase defaults 0.

2. Set the carrier frequency and the carrier amplitude

A) Press **FREQ** and enter 1GHz with the numeric keypad, or click the frequency input box on the touch screen to pop up the keypad to input 1GHz on the keypad.

B) Press **LEVEL**, type -10 dBm with the digital keyboard, or click on the amplitude input box on the touch screen, pop up the keyboard, and type – 10dBm on the keyboard;

3. Set the AM modulation parameters

Press the **MOD** or click the MOD function block on the touchscreen to enter the amplitude modulation parameter setting interface.

A) Set the modulation waveform to be a sine wave;

B) Set the modulation depth to 80%;

C) Set the modulation frequency to be 10 kHz;

D) Set the AM state open;

4. Enable the RF modulation output

SIGLENT

Press **MOD On/OFF** and then press **RF ON/OFF**. The backlights of **MOD On/OFF** and **RF ON/OFF** will be illuminated. RF and MOD labels in the status bar will change from gray to blue. At this time, the signal on the **[RF OUTPUT 50Ω]** connector will match the settings configured above.

3.3 Output a pulse train

A pulse train is a user-defined sequence of high and low RF levels with specific time durations for each part. In this example, we will show how to configure the RF source to output the following pulse train:

Serial number	Positive pulse width	Negative pulse width	Repetitions
1	10ms	30ms	1
2	20ms	20ms	2

1. Restore the factory default settings

A) Press **UTILITY** or the touch **Preset Type-> Default**.

B) Press **PRESET** or reset the system settings to perform the reset operation. Make the frequency offset and the phase defaults 0.

2. Install the pulse train option

Activate the pulse train generator option.

3. Edit pulse list

A) Press **MOD** or select MOD from the Home page. You can swipe left or right or press **MOD** repeatedly to reach the Pulse Mode screen. Set Pulse Mode to Train, and the Pulse Train menu will appear.

B) Click  in Pulse Train menu to enter settings, set the positive width of first pulse to 10ms, the negative width to 30ms, and the count to 1.

C) Click the “+” on the left to add one line, set the positive pulse width to 20ms, the

negative pulse width to 20ms, and the count to 2.

D) After clicking, you can click  on the left side to see the schematic diagram of the pulse train as follows.

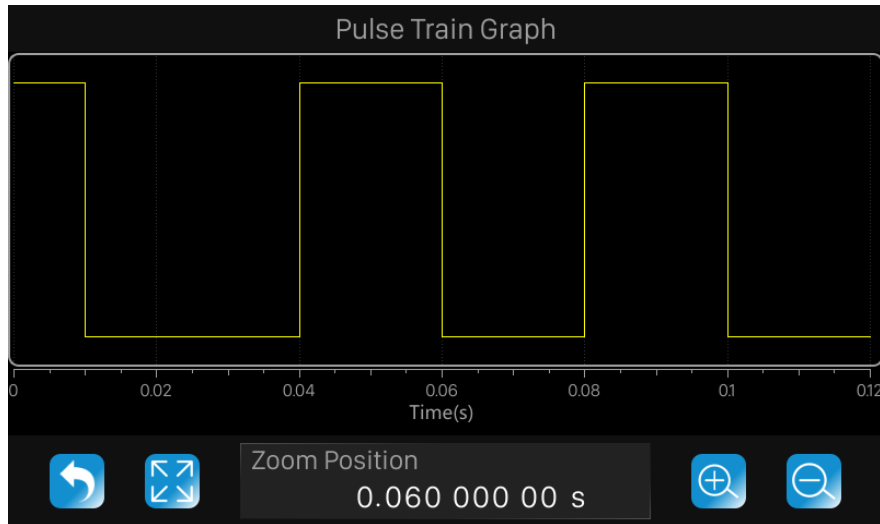

4. Set the **Pulse State** to on.

5. Enable the RF modulation output

Press **MOD On/OFF** and then press **RF ON/OFF**. The backlights of **MOD On/OFF** and **RF ON/OFF** will be illuminated. RF and MOD labels in the status bar will change from gray to blue. At this time, the signal on the **[RF OUTPUT 50Ω]** connector will match the settings configured above

3.4 Output IQ modulated signal

The external modulation function (optional) of the SSG3000X and the SDG6000X series arbitrary waveform generator can be used as the baseband source to generate an IQ modulated signal.

The following steps describe how to generate an IQ modulated signal with a modulation mode of 32QAM. Users can modify and configure IQ modulation related parameters according to actual application requirements.

1. Connect the output interface of the SDG6000X to the external modulation interface of the SSG3000X;



2. Open the EasyIQ software, configure it as shown below, and download the baseband data to the SDG6000X;

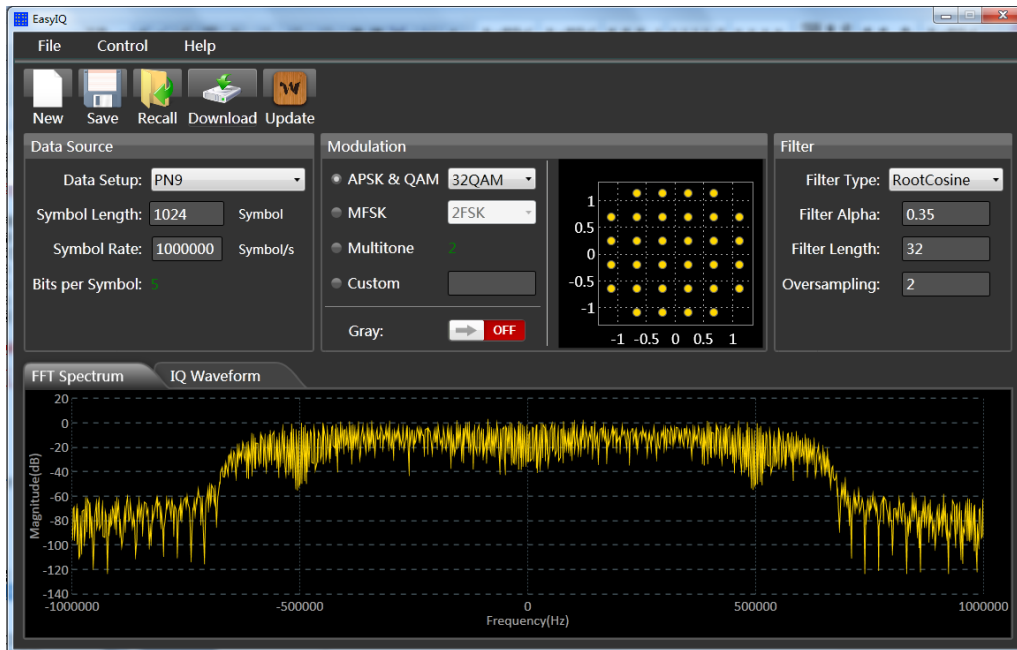

- As shown in the figure below, configure the SSG3000X and SDG6000X separately, and then enable the output of the SDG6000X, the IQ, MOD and RF output of the SSG3000X;

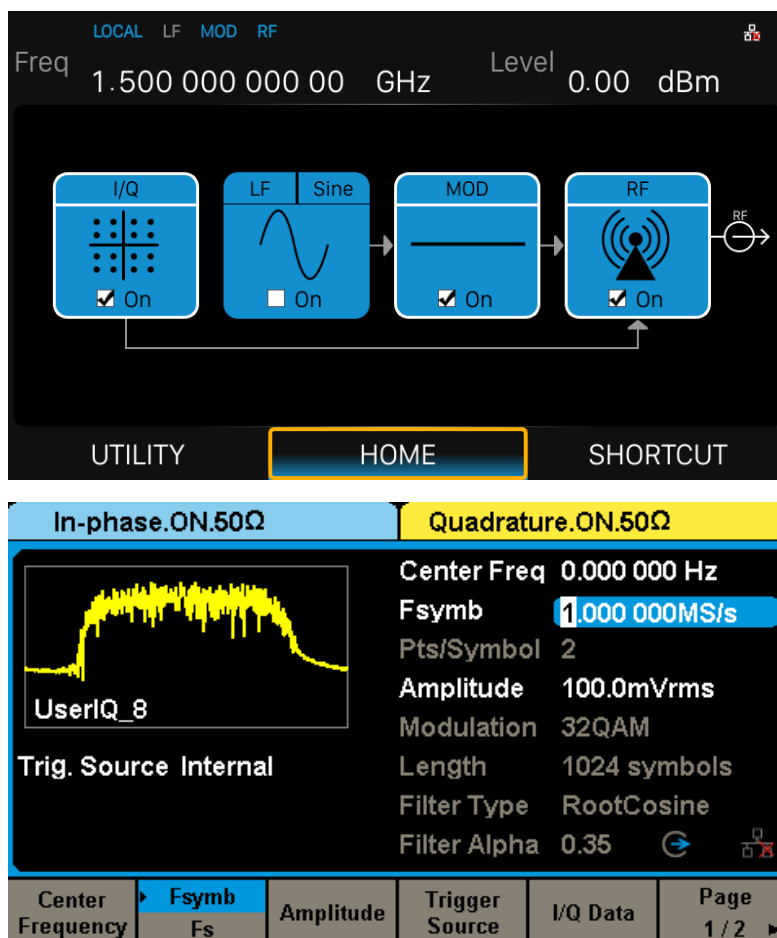

- At this time, the RF interface of the SSG3000X outputs an IQ modulation signal with a modulation mode of 32QAM, and the IQ modulation signal is connected to an IQ demodulation device to observe the demodulation characteristics of the IQ modulation signal;

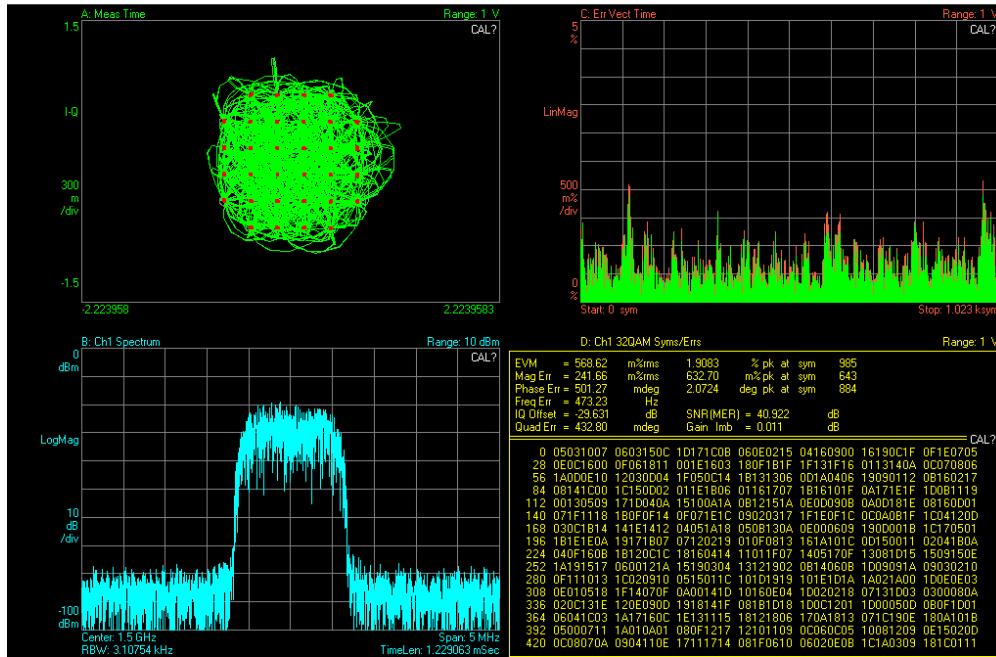

Note: IQ compensation can be performed through the I/Q adjustment menu of the SDG6000X. For example, when the IQ modulation signal shows a significant local oscillator leakage, it can be solved by alternately adjusting the Offset of I and Q.

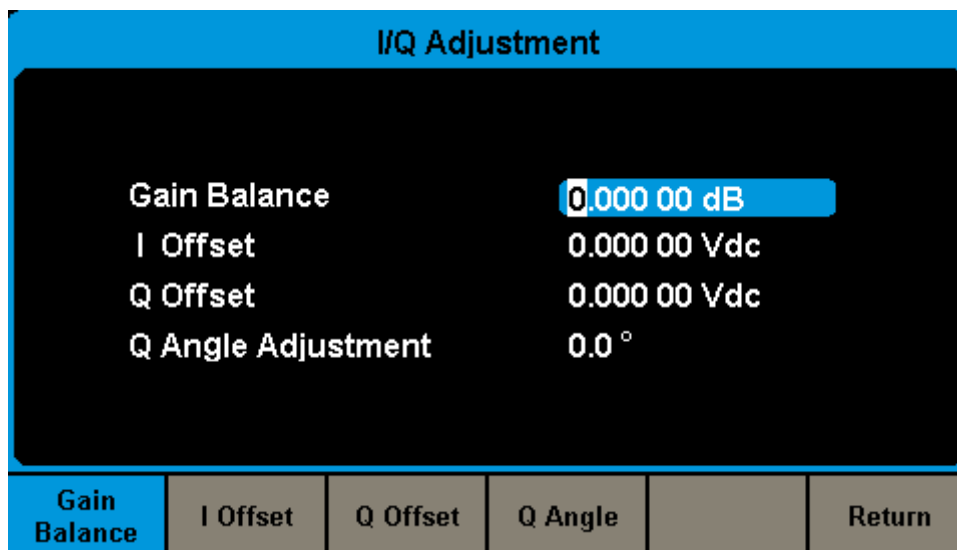

3.5 Test the OIP3 of Active Devices with the SSG3000X

OIP3 is a key indicator for evaluating the linearity of active devices. This can be tested using the SSG3000X with the SDG6000X series of arbitrary waveform generators.

The following steps describe how to generate a two-tone continuous wave signal with a carrier frequency of 1 GHz and an interval frequency of 1 MHz to test the OIP3 of the active device.

1. Connect the output interface of the SDG6000X to the external modulation interface of the SSG3000X;
2. Open the EasyIQ software, configure it as shown below, and download the Multitone data to the SDG6000X;

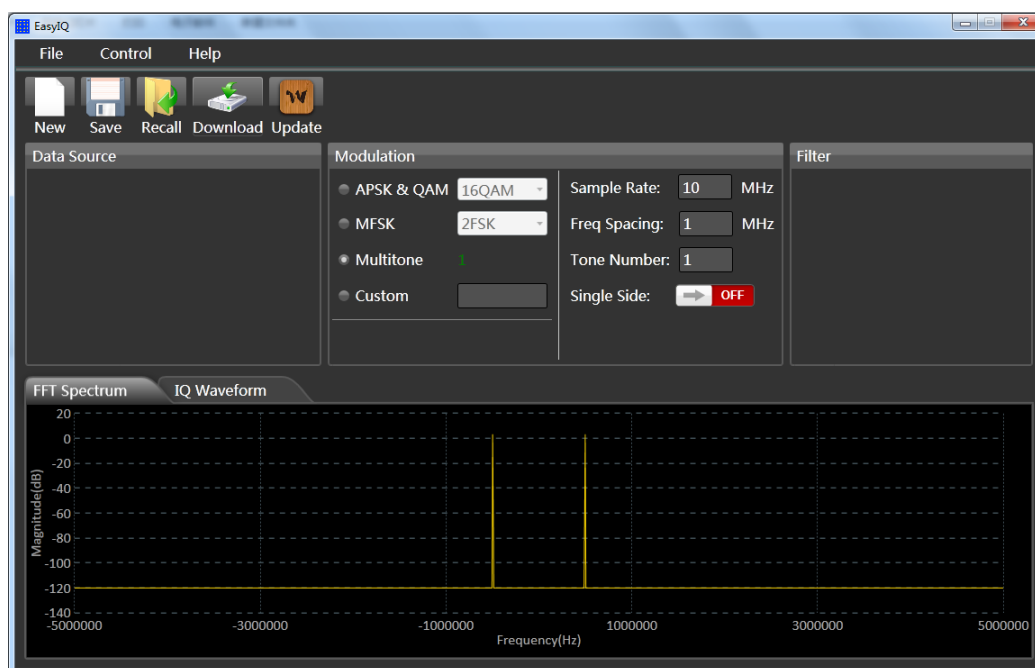

3. Configure the SSG3000X and SDG6000X as shown below, then open the output of the SDG6000X, the IQ, MOD and RF output of the SSG3000X;

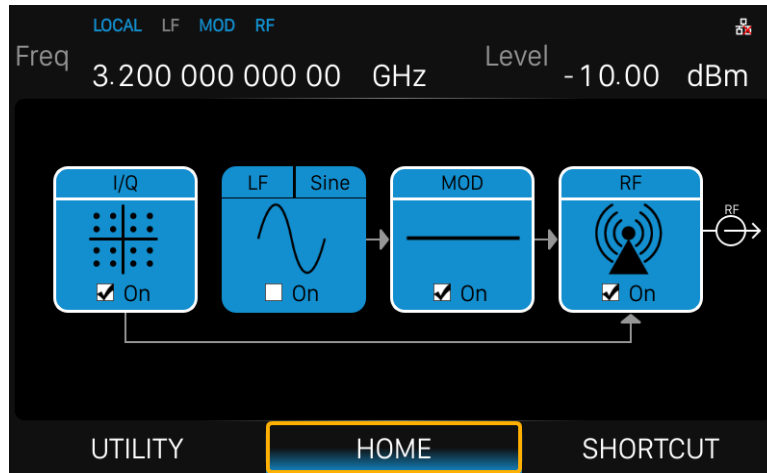

- At this time, the RF interface of the SSG3000X outputs a two-tone continuous wave signal with a carrier frequency of 1 GHz and an interval frequency of 1 MHz. The signal is used as the input of the active device, and the output signal is tested to obtain the OIP3 characteristic as shown in the following figure.

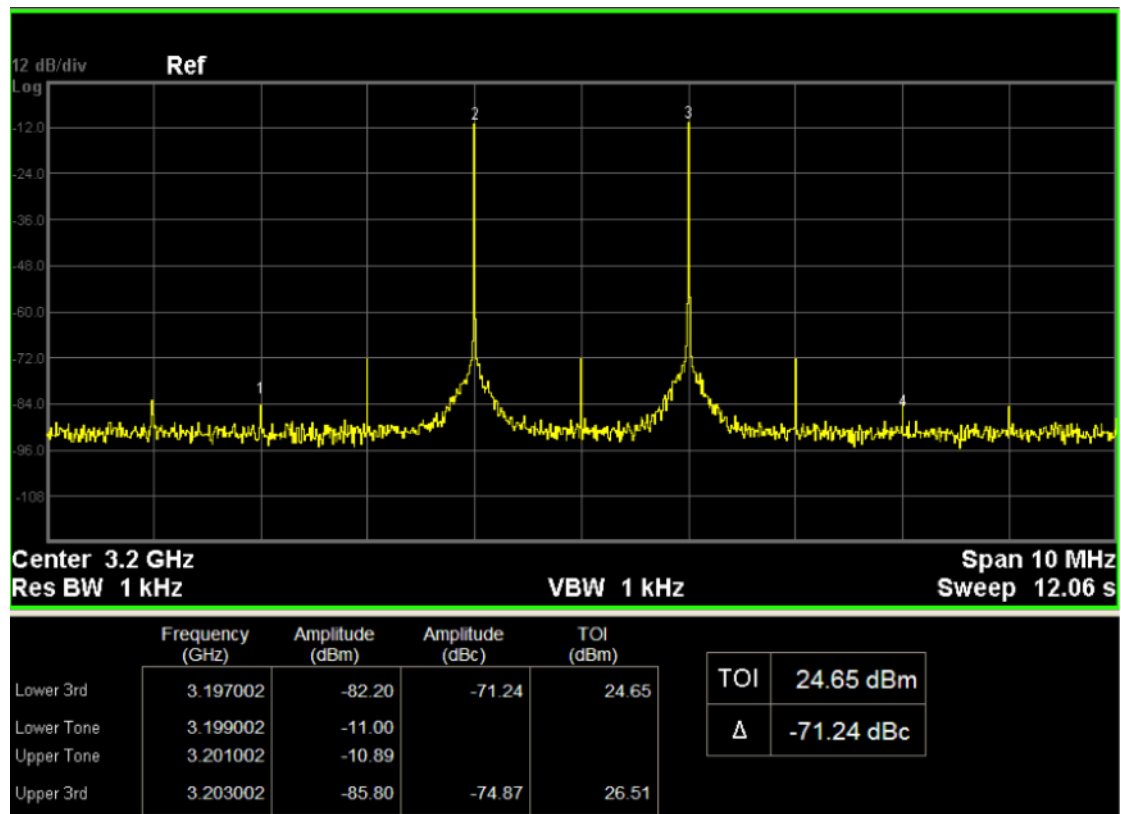

Note: IQ compensation can be performed through the I/Q Adjustment menu of the SDG6000X. For example, when the IQ modulation signal shows a significant local

oscillator leakage, it can be solved by alternately adjusting the Offset of I and Q.

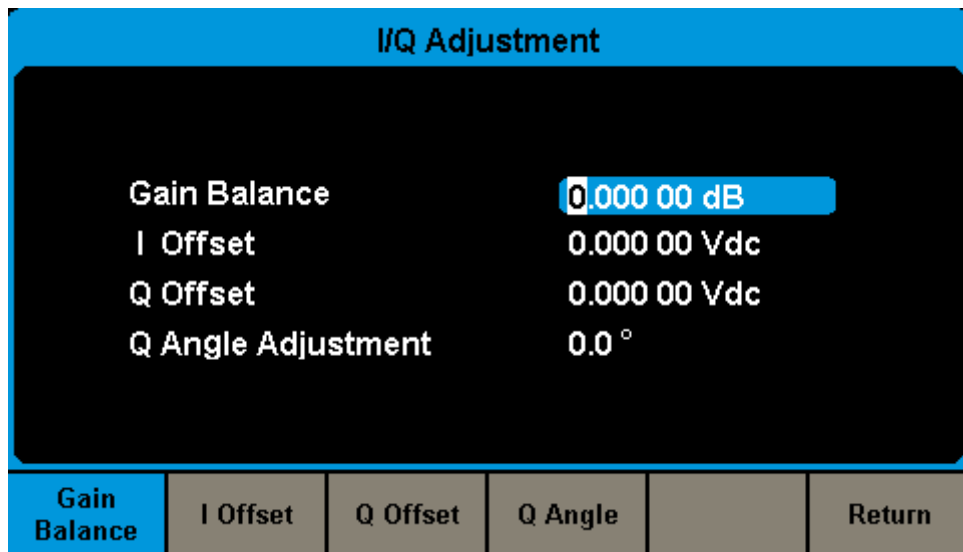

Chapter 4 Programming Overview

The SSG3000X Signal Generator features a LAN, USB Device, and SIGLENT GPIB—USB module interfaces. By using a computer with these interfaces, and a suitable programming language (Python, C+, .NET, etc, and NI-VISA software), users can remotely control the signal generator using standard SCPI (Standard Commands for Programmable Instruments) commands. The SSG3000X Programming Guide features more details on the specific commands.

This chapter introduces how to build communication between the signal generator and a controller computer with these interfaces.

4.1 Remote Operation

The SSG provides both the USB and LAN connection which allows you to set up a remote operation environment with a controller computer. A controller computer could be a personal computer (PC) or a minicomputer. Some intelligent instruments also function as controllers.

4.1.1 Connecting via the USB Device port

Refer to the following steps to finish the connection via USB-Device:

1. For standard installations, you can use NI-VISA on your PC for the VXI driver. If you wish to control the instrument without NI-VISA, use sockets or telnet.
2. Connect the SSG USB Device port to a PC with a USB A-B cable.
3. Switch on the SSG



Figure 4-1 USB Device

The SSG will be detected automatically as a new USB hardware.

4.1.2 Connecting via the LAN port

Refer to the following steps to finish the connection via LAN:

1. Install NI-VISA on your PC for VXI driver. Or without NI-VISA, using socket or telnet in your PC's Operating System.
2. Connect the SSG to PC or the local area network with a LAN cable
3. Switch on the SSG



Figure 4-2 LAN

4. Press button on the front panel **System** → Interface → LAN to enter the LAN Configure function menu.
5. Select the IP Configure between Static and DHCP
 - ◆ DHCP: the DHCP server in the current network will assign the network parameters automatically (IP address, subnet mask, gate way) for the SSG.
 - ◆ Static: you can set the IP address, subnet mask, gate way manually. Press Apply.

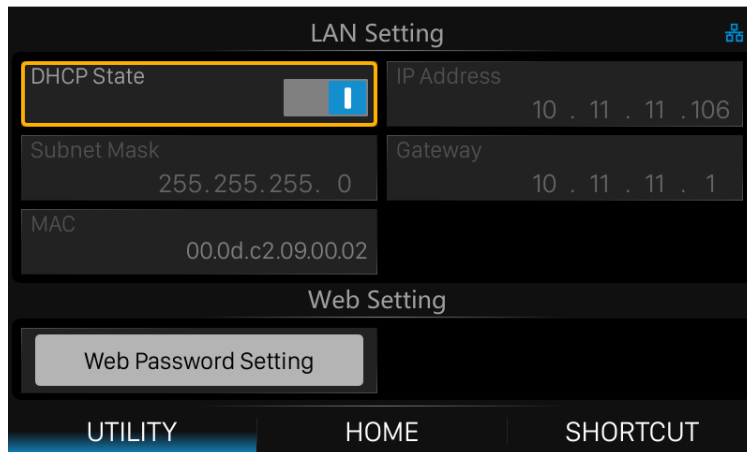

Figure 4-3 LAN Configure

The SSG will be detected automatically or manually as a new LAN point.

4.1.3 GPIB: Connecting via the USB-Host port

Refer to the following steps to finish the connection via USB:

1. Install NI-VISA on your PC for GPIB driver.
2. Connect the SSG USB Host port to a PC's GPIB card port, with SIGLENT USB-GPIB adaptor.
3. Switch on the SSG



Figure 4-4SIGLENT USB-GPIB Adaptor

4. Press button on the front panel **System** → Interface → GPIB to enter the GPIB number.

The SSG will be detected automatically as a new GPIB point.

4.2 Build Communications

4.2.1 Build Communications Using VISA

NI-VISA includes a Run-Time Engine version and a Full version. The Run-Time Engine version provides NI device drivers such as USB-TMC, VXI, GPIB, etc. The full version includes the Run-Time Engine and a software tool named NI MAX that provides a user interface to control the device.

You can get NI-VISA full version from:

<http://www.ni.com/download/>.

After download you can follow the steps below to install it:

1. Double click the visa_full.exe, dialog shown as below:

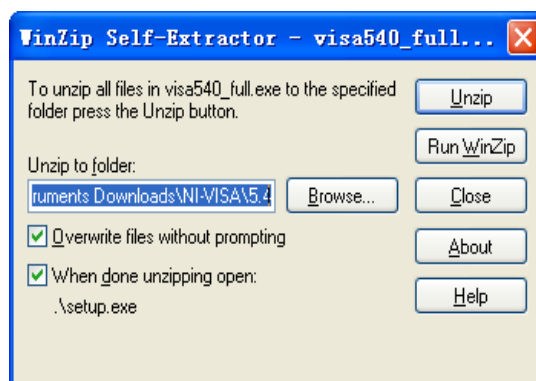

2. Click Unzip, the installation process will automatically launch after unzipping files. If your computer needs to install .NET Framework 4, its setup process will auto start.



3. The NI-VISA installing dialog is shown above. Click Next to start the installation process.

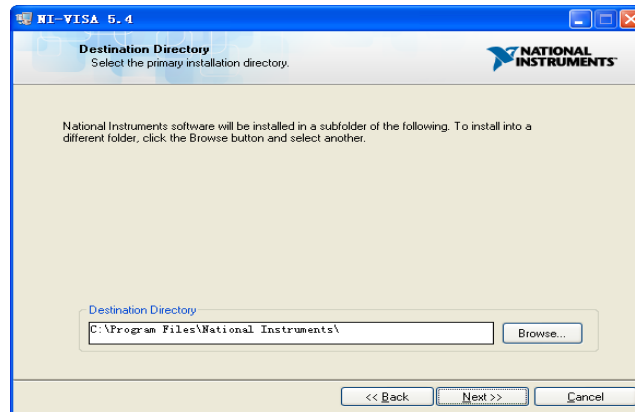

4. Set the install path, default path is “C:\Program Files\National Instruments\”, you can change it. Click Next, dialog shown as above.

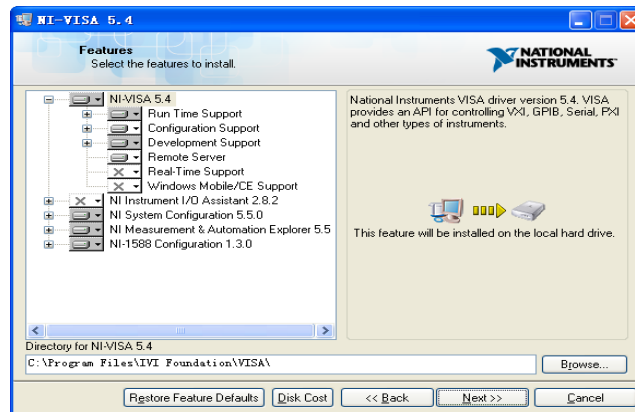

5. Click Next twice, in the License Agreement dialog, select the “I accept the above 2 License Agreement(s).”, and click Next, dialog shown as below:

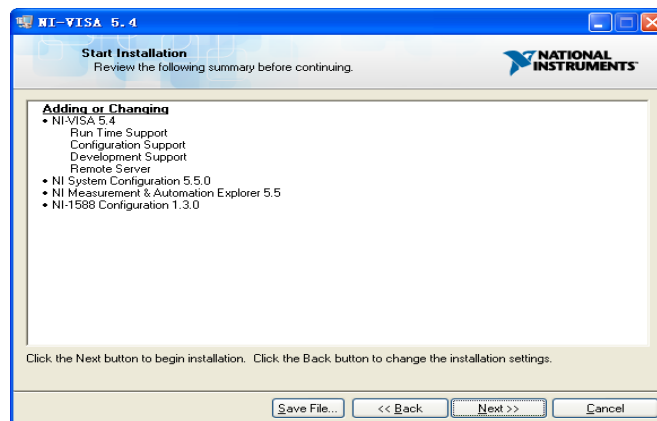

6. Click Next to run installation.

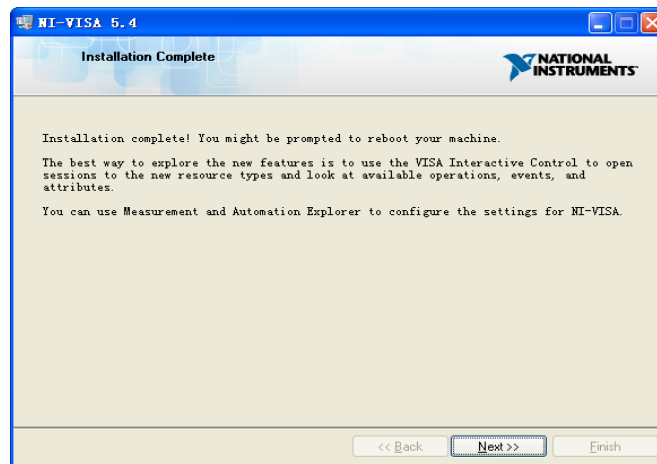

Now the installation is complete, reboot your PC.

4.2.2 Build Communications Using Sockets/Telnet

Through the LAN interface, VXI-11, Sockets and Telnet protocols can be used to communicate with the SSG. VXI-11 is provided in NI-VISA, while Sockets and Telnet are commonly included in the operating system (OS) of many computers.

Socket LAN is a method used to communicate with the signal generator over the LAN interface using the Transmission Control Protocol/Internet Protocol (TCP/IP). A socket is a fundamental technology used for computer networking and allows applications to communicate using standard mechanisms built into network hardware and operating systems. The method accesses a port on the signal generator from which bidirectional communication with a network computer can be established.

Before you can use sockets LAN, you must select the signal generator's sockets port number to use:

- **Standard mode:** Available on port 5025. Use this port for programming.
- **Telnet mode:** The telnet SCPI service is available on port 5024.

4.3 Remote Control Capabilities

4.3.1 User-defined Programming

Users can use SCPI commands to program and control the signal generator. For details, refer to the introductions in “**Programming Guide**”.

4.3.2 Send SCPI Commands via NI MAX

Users can control the signal generator remotely by sending SCPI commands via NI-MAX software. NI_MAX is National Instruments Measurement and Automation Explorer. It is an executable program that enables easy communication to troubleshoot issues with instrumentation.

4.3.2.1 Using USB

Run NI MAX software.

1. Click “Device and interface” at the upper left corner of the software;
2. Find the “USBTMC” device symbol



3. Click “Open VISA Test Panel” option button, then the following interface will appear.
4. Click the “Input/Output” option button and click the “Query” option button in order to view the operation information.

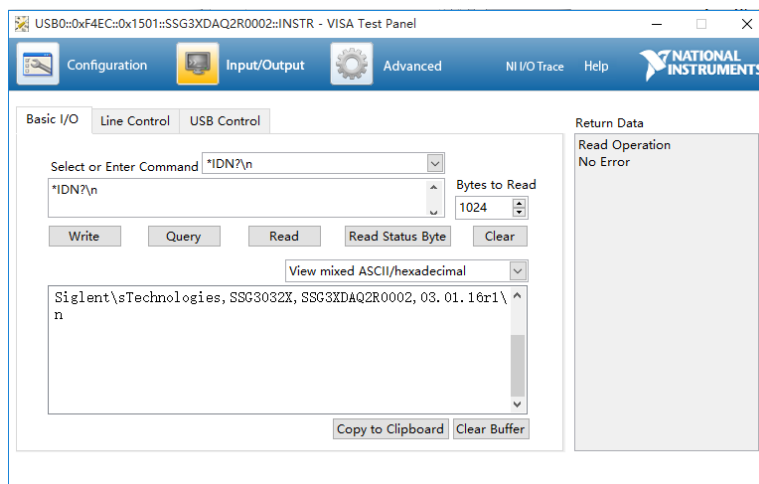

NOTE: The “*IDN?” command (known as the Identification Query) returns the instrument manufacturer, instrument model, serial number, and other identification information.

4.3.2.2 Using LAN

Select “Add Network Device”, and select “VISA TCP/IP Resource” as shown:

Run NI MAX software.

1. Click “Device and interface” at the upper left corner of the software;
2. Find the “Network Devices” symbol, click “Add Network Devices”;

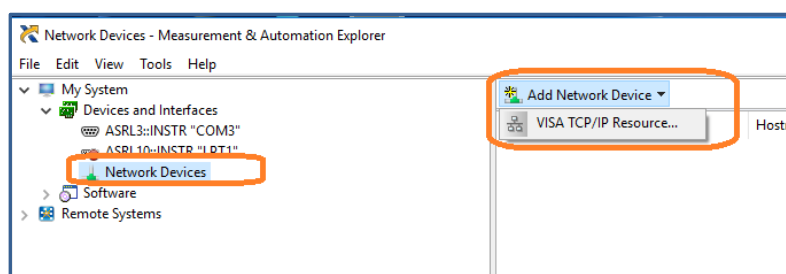

3. Select Manual Entry of LAN instrument, select next, and enter the IP address as shown. Click Finish to establish the connection:

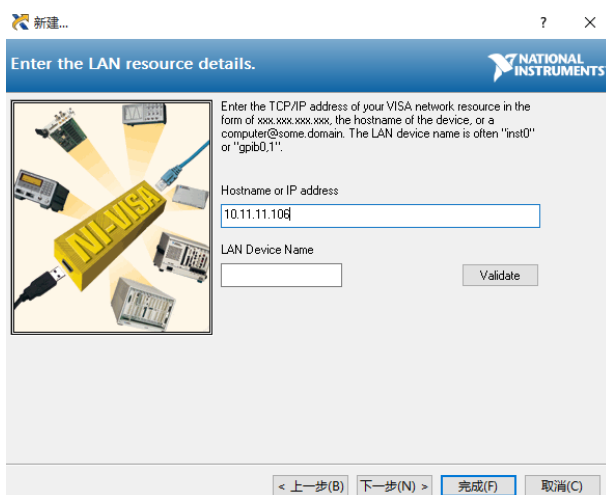
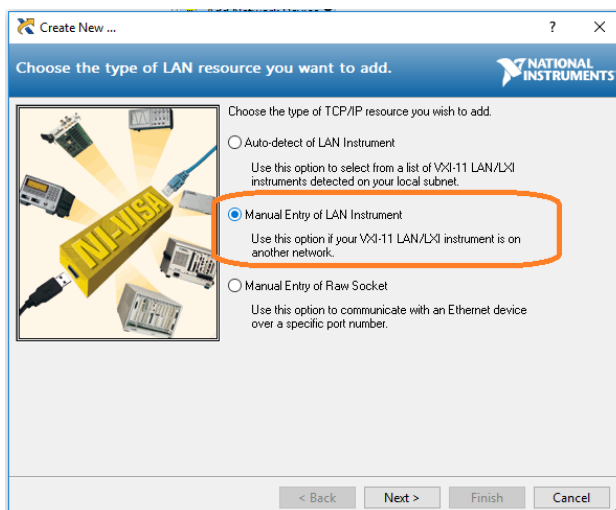

4. After a brief scan, the connection should be shown under Network Devices:



5. Click “Open VISA Test Panel” option button, then the following interface will appear:

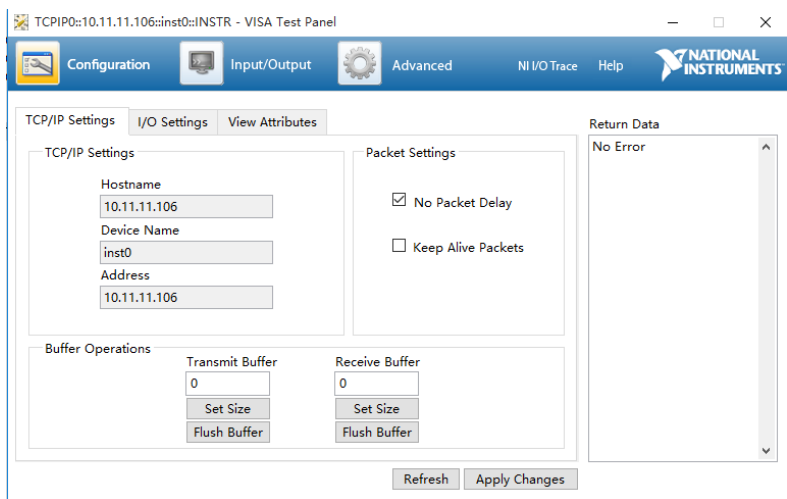

- Click “Input/Output” option button and click “Query” option button. If everything is OK, you will see the Read operation information returned as shown below.

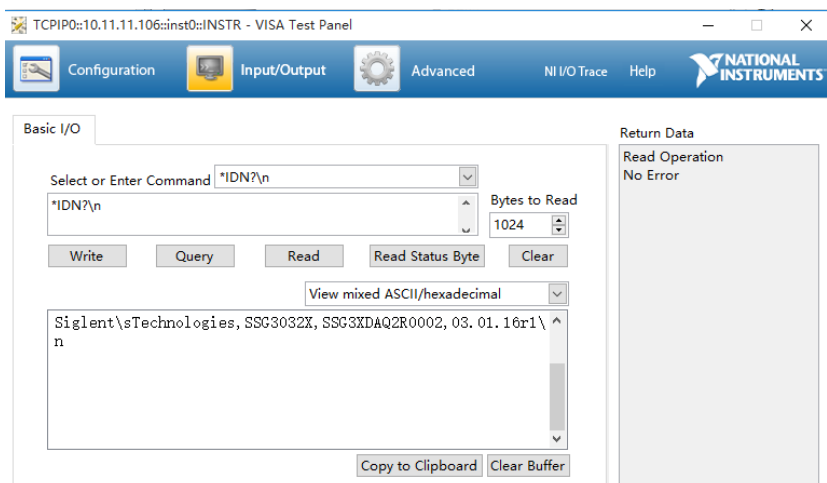

4.3.1 Web Control

With the new embedded web server, users can control the SSG through LAN from a web browser on PC or mobile terminals. This provides wonderful remote controlling and monitoring capabilities.

Chapter 5 Service and Support

5.1 General Inspection

1. Inspect the shipping container

Keep the damaged shipping container or cushioning material until the contents of the shipment have been completely checked and the instrument has passed both electrical and mechanical tests.

The consigner or carrier will be responsible for damages to the instrument resulting from shipment. **SIGLENT** will not provide free maintenance or replacement.

2. Inspect the instrument

If the instrument is found to be damaged, defective or fails in electrical or mechanical tests, please contact **SIGLENT**.

3. Check the accessories

Please check the accessories according to the packing list. If the accessories are incomplete or damaged, please contact your **SIGLENT** sales representative.

5.2 Troubleshooting

Before calling **SIGLENT**, or returning an SSG for service, perform the quick checks listed below. This check may eliminate the problem.

If the problem remains still, please contact **SIGLENT** and provide your device information of the SSG (Get method: **UTILITY**->**System Info**).

1. The SSG's screen is still dark (no display) after power on:

(1) Check whether the fan is running:

- If yes, the connection of the internal screen cable may be loose.
- If not, the instrument has failed to start up and please refer to step (2).

(2) Check the power:

- Check whether the power supply has been connected correctly and the power switch has been turned on.
- Check whether the power fuse is burned. If a new fuse needs to be installed, please use the specified fuse type/rating.

2. The key is unresponsive or gives a wrong response:

(1) Press all the keys at the front panel to check if all of them are normal after power on.

(2) Press **Utility** -> **Self Test** -> **Key Test** to check if all the keys are working properly.

(3) If a key is not working, the numeric keyboard connection might be loose or the numeric keyboard is broken.

Do not disassemble the instrument by yourself and contact **SIGLENT**.

3. Correct setting but incorrect waveform output

(1) No RF output

— Check that the signal cable is securely connected to the corresponding [RF OUTPUT 50 Ω] port.

— Check the cable for damage.

— Check if the RF button backlight is lit. If not lit, press this button to light it and the user interface status bar RF flag turns blue. The RF output is now turned on correctly.

— Check if the signal output amplitude is too small, and adjust the output amplitude appropriately.

(2) No modulation on the RF output

-
- Check that the signal cable is securely connected to the corresponding [RF OUTPUT 50 Ω] port.
 - Check the cable for damage.
 - Check that both the MOD and RF button backlights are lit and that the modulation switch needs to be turned on.
 - Check if the modulation parameters are appropriate and modulate the modulation parameters appropriately.
 - If an external modulation source is used, make sure that the external source is connected correctly and has an output and should work within the range established by the source.

4. Sweep is abnormal:

(1) Scanning stagnation

The user interface frequency zone/amplitude zone displays a scan progress bar indicating that a scan operation is in progress. If there is stagnation, check the points.

- Open at least one scan type: Select Frequency, Amplitude, or Frequency & Amplitude according to the SWEEP scan type status.
- If the single scan mode is enabled, a single scan is performed when the single software meets the trigger condition.
- If the scan trigger mode is not automatic trigger, press SWEEP trigger mode to automatically trigger to determine if the scan trigger is missing and the scan is blocked.
- If the point trigger mode is not automatic trigger, it is automatically triggered by the SWEEP trigger mode to determine if the point trigger is missing and the scan is blocked.
- Determine if the dwell time setting is too large or too small for the scan to be visible.
- Make sure at least two points are set in the step scan or list scan.

(2) In the list or step scan, the amplitude does not change

- Verify that the scan type is set to Amplitude or Frequency & Amplitude.

—If the current scan type is set to Frequency, the amplitude value does not change.

5. USB device cannot be recognized:

(1) Check if the USB device is connected to other instruments or the computer can work normally.

(2) Confirm the flash type U disk device used. This instrument does not support the hard disk type U disk device.

(3) After restarting the instrument, insert the USB flash drive to check.

(4) If you are unable to use the USB flash drive normally, please contact.

6. Inaccurate measurement results or insufficient accuracy:

Users can obtain detailed descriptions of technical indicators from the back of this manual to calculate system errors and check measurement results and accuracy issues. To achieve the performance metrics listed in this manual, you need:

(1) Check if the RF signal source is within the calibration period (1 year).

(2) Verify that the RF signal source has been warmed up for at least 30 minutes before testing.

(3) Check that the performance of the test equipment used meets the requirements.

(4) Ensure that the test equipment used is within the calibration cycle.

(5) Check if the test equipment used is under the working conditions required by its manual.

(6) Check if all connections are tightened.

7. Pop-up Message:

The instrument may display prompt messages, error messages or state messages according to the current working status. These messages are displayed to help you to use the instrument correctly and are not instrument failures.

Chapter 6 Service and Support

6.1 Service Summary

SIGLENT warrants that the products that it manufactures and sells will be free from defects in materials and workmanship for a period of three years (accessories for a period of one year) from the date of shipment from an authorized Siglent distributor. If the product proves defective within the respective period, **SIGLENT** will provide repair or replacement as described in the complete warranty statement.

To arrange for service or obtain a copy of the complete warranty statement, please contact your nearest Siglent sales and service office. Except as provided in this summary or the applicable warranty statement, **SIGLENT** makes no warranty of any kind, express or implied, including without limitation the implied warranties of merchantability and fitness for a particular purpose. In no event shall **SIGLENT** be liable for indirect, special or consequential damages.

6.2 Contact Us

China:

SIGLENT TECHNOLOGIES CO., LTD.

Add: Bldg. No.4 & No.5, Antongda Industrial Zone, 3rd Liuxian Road, Bao'an District, Shenzhen, 518101, China.

Tel: + 86 755 3661 7876

Fax: + 86 755 3359 1582

Email: sales@siglent.com;

Website: <http://www.siglent.com/ens/>

USA:

SIGLENT Technologies America, Inc.

6557 Cochran Rd Solon, Ohio 44139

Tel: 440-398-5800

Toll Free: 877-515-5551

Fax: 440-399-1211

Email: info@siglent.com

Website: www.siglentamerica.com

Europe:

SIGLENT TECHNOLOGIES EUROPE GmbH

ADD: Liebigstrasse 2-20, Gebaeude 14, 22113 Hamburg Germany

Tel: +49(0)-819-95946

Fax: +49(0)-819-95947

Email: info-eu@siglent.com

Website: www.siglenteu.com