



User Manual

SDM3065X Digital Multimeter

UM06036-E01B

2017 SIGLENT TECHNOLOGIES CO., LTD

Copyright and Statement

Copyright

SIGLENT TECHNOLOGIES CO., LTD. All rights reserved.

Trademark Information

SIGLENT is registered trademark of SIGLENT TECHNOLOGIES CO., LTD.

Statement

- **SIGLENT** products are protected by patent laws in and outside of the P.R. China.
- **SIGLENT** reserves the rights to change the specification and price.
- Information in this publication replaces all previous corresponding published material.
- Contents in this manual are not allowed to be copied, extracted or translated in any form or by any means without **SIGLENT**'s permission.

General Safety Summary

Read the following safety precautions carefully to avoid any personal injuries or damages to the instrument and any products connected to it. To avoid potential hazards, please use the instrument as specified.

Use proper power line.

It's only allowed to use the special power line which is approved by local state.

Ground the instrument.

The instrument is grounded through the protective terra conductor of the power line. The ground conductor must be connected to the earth to avoid electric shock. Make sure the instrument is grounded correctly before connecting its input or output terminals.

Connect the signal wire correctly

The potential of the signal wire is equal to the earth, so do not connect the signal wire to a high voltage.

Observe all terminal ratings

Please observe all ratings and sign instructions on the instrument to avoid fire or electric shock. Before connecting the instrument, please read the manual carefully to gain more information about the ratings.

Do not operate with suspected failures

If you suspect that the product is damaged, please contact SIGLENT's qualified service personnel to inspect it. Any repair and adjustment to the product or replacing a component should be done by qualified personnel only.

Avoid circuit or wire exposure

Don't touch exposed contacts or components when the power is on.

Don't operate without covers.

Don't operate the instrument with covers or panels removed.

Use proper fuse.

It's only allowed to use the specified fuse for the instrument.

Use proper over-voltage protection.

Make sure there is no over-voltage (like voltage caused by thunder and lightning) reaching to the instrument, otherwise the operator may suffer an electric shock.

Antistatic protection.

Static electricity will cause damages to the instrument, so test in antistatic areas as far as possible. Ground its inner and outer conductors to release the static electricity temporarily before connecting the cable to the instrument.

Keep good ventilation.

Improper ventilation will cause the rise of the instrument's temperature. Keep good ventilation and check the vent and fan regularly when using it.

Keep the surface of the instrument clean and dry.**Do not operate in wet or damp conditions.****Do not operate in flammable or explosive environment.**

The disturbance test of all the models meets the limit values of A in the standard of EN 61326-1:2013.

Input terminal protection limitation

Protection limitation is defined for the input terminal:

1. Main input (HI and LO) terminal

HI and **LO** terminals are used for Voltage, Resistance, Capacitance, Continuity, Frequency and Diode measurement. Two protection limitations are defined:

- **HI-LO protection limitation:** 1000VDC or 750AVC. It's the maximum measurable voltage. The limitation can be expressed as 1000Vpk.
- **LO-ground protection limitation:** **LO** terminal can "float" 500Vpk relative to the ground safely. The maximum protection limitation of **HI** terminal relative to the ground is 1000Vpk. Therefore, the sum of the "float" voltage and the measured voltage can't exceed 1000Vpk.

2. Sampling (HIsense and LOsense) terminal

HIsense and **LOsense** are used for 4-wire Resistance measurement. Two protection limitations are defined:

- **HIsense-LOsense protection limitation:** 2000Vpk.
- **LOsense-LOsense protection limitation:** 2Vpk.

3. Current input (I) terminal

I and **LO** terminals are used for current measurement. The maximum current which go through the **I** terminal is limited to 10A by the fuse on the back panel.

NOTE:

Voltage on the current input terminal corresponds to voltage on LO terminal. To keep good protection, only use the fuse of specified type and level to replace this fuse.

IEC Measurement Category II Over-voltage Protection

SDM3065X Digital Multimeter provides over-voltage protection for line-voltage mains connections meeting both of the following conditions to avoid the danger of electric shock:

- The **HI** and **LO** input terminals are connected to the mains under Measurement Category II conditions as following.
- The maximum line voltage of the mains is 600VAC.

WARNING:

IEC Measurement Category II includes electrical devices connected to mains at an outlet on a branch circuit, such as most small appliances, test equipments, and other devices that plug into a branch outlet or socket.

SDM3065X is capable of making measurements with the **HI** and **LO** inputs connected to mains in such devices (up to 600VAC) or the branch outlet itself. However, the **HI** and **LO** terminals of SDM3065X can't be connected to mains in permanently installed electrical devices such as the main circuit-breaker panels, sub-panel disconnected boxes and permanently wired motors. Such devices and circuits are prone to exceed the protection limits of SDM3065X.

NOTE:

Voltages above 600VAC only can be measured in circuits that are isolated from mains. However, there may be transient over-voltage in circuits that are isolated from mains. SDM3065X is able to withstand occasional transient over-voltage up to 4000Vpk. Please don't use this instrument to measure circuits that transient over-voltage may exceed this level.

Safety Terms and Symbols

Terms in this manual. Terms may appear in this manual.



WARNING: Warning statements indicate the conditions and behaviors that could result in injury or loss of life.



CAUTION: Caution statements indicate the conditions and behaviors that could result in damage to this product or other



CAT I (1000V): IEC Measurement Category I. The highest measurable voltage is 1000Vpk in the HI-LO terminal.



CAT II (600V): IEC Measurement Category II. Inputs may be connected to mains (up to 600VAC) under Category II overvoltage

Terms used on the instrument. Terms may appear on the instrument:

DANGER indicates an injury or hazard that may immediately happen.

WARNING indicates an injury or hazard that may not immediately happen.

CAUTION indicates that a potential damage to the instrument or other property might occur.

Symbols used on the instrument. Symbols may appear on the instrument.



**Hazardous
Voltage**



**Protective Earth
Ground**



Warning



**Test
Ground**



**Chassis
Ground**

Daily Maintenance and Cleaning

Maintenance

When storing or placing the instrument, please avoid the liquid crystal display from direct sunlight for a long time.

NOTE:

To avoid damages to the instrument or probe, please don't place them in mist, liquid or solvent.

Cleaning

Please often clean the instrument or probe according to the use of them.

- Wipe the external ash of the instrument and probe by a soft rag. Be careful not to scratch the transparent plastic protective screen when cleaning the liquid crystal screen.
- Use a soft rag that has been soaked by water to clean the instrument after cutting off the power. Or use 75% isopropyl alcohol of water solvent to get a more thorough cleaning.

NOTE:

- To prevent the surface of the instrument or probe from damages, please don't use any corrosive or chemical cleaning reagents.
- Please make sure the instrument is already dry before restarting it to avoid short circuits or personal injuries caused by water.

Introduction of SDM3065X

SDM3065X is a 6½ dual-display instrument, especially fitting to the needs of high-precision, multifunction, and automation measurements. It realized a combination of basic measurement functions, multiple math functions, and display functions, etc.

SDM3065X holds a 4.3 inch color TFT-LCD display screen with 480*272 high resolutions. Its clear keyboard layout and operation hints make it easier and agility to use. Besides, it supports multi-interface such as USB Device & Host, LAN and USB-GPIB (optional), which can meet users' demand furthest.

Main Features:

- 4.3 inch color TFT-LCD display screen with 480*272 high resolutions
- Real 6½ digits readings resolution
- Up to 150rdgs/S measurement speed
- True-RMS AC Voltage and AC Current measurements
- 1 Gb Nand Flash size, mass storage configuration files and data files
- Built-in cold terminal compensation for thermocouple
- Support standard SCPI and control software on PC, compatible with commands of main stream multimeters
- Supports dual-display function, Chinese and English menu
- Built-in help system, convenient to acquire information
- Support USB Device, USB Host, LAN, and GPIB (only for SDM3065XA) interfaces
- Configuration and measured data can be imported or exported via VXI 11, USBTMC and USB flash drive, which is convenient for users to modify, view and backup

Abstract

The manual mainly introduces corresponding information of operating the SDM3065X Digital Multimeter. It contains these chapters:

Chapter 1 Quick Start

Guide you to prepare the SDM3065X Digital Multimeter and know about the Front/Back panel and user interface.

Chapter 2 Function and Operation

Introduce the functions and operations of SDM3065X in details.

Chapter 3 Application Examples

Introduce you how to use strong measurement functions of this instrument easily through some examples.

Chapter 4 General Troubleshooting

Provide you some general troubleshooting.

Chapter 5 Appendix

Provide you information about accessories, warranties, troubleshooting, services and supports.

Content

Copyright and Statement	I
General Safety Summary	II
Safety Terms and Symbols	V
Daily Maintenance and Cleaning	VI
Introduction of SDM3065X	VII
Abstract.....	VIII
Chapter 1 Quick Start	1
General Inspection.....	2
To adjust the Handle.....	3
Appearance and Size.....	4
Front Panel	5
Back Panel.....	8
Start the Multimeter.....	11
User Interface	12
Measurement Connections	13
To Use the Built-in Help System	16
Chapter 2 Function and Operation	17
Measurement Configuration.....	18
Range	19
Integration Time and Resolution.....	21
DC Impedance.....	23
Auto Zero.....	24
AC Filter.....	25
Short-circuit Resistance.....	26
Gate Time	27
Basic Measurement Functions.....	28
To Measure DC Voltage	29
To Measure DC Current	31
To Measure AC Voltage	33
To Measure AC Current.....	35
To Measure Resistance.....	37
To Measure Capacitance.....	40
To Measure Frequency or Period	42
To Test Continuity.....	44
To Test Diode	46
To Measure Temperature	48
Dual-display Function	51
Utility Function	53
Store and Recall	54
Manage File.....	58
I/O Configuration.....	59
Board Test.....	61

Firmware Update	64
System Setup	65
Acquire.....	67
Auto Trigger	68
Sample Count	68
Single Trigger	69
External Trigger	70
Help System	71
Math Function	73
Statistics	75
Limits	77
dBm	79
dB	80
Relative Value.....	81
Display Mode	82
Trigger	88
Hold Measurement Function.....	89
Chapter 3 Measurement Tutorial	90
True RMS AC Measurement.....	90
Crest Factor Errors (non-sinusoidal inputs)	91
Loading Errors (AC Voltage).....	92
Chapter 4 General Troubleshooting	93
Chapter 5 Appendix.....	94
Appendix A: Accessories	94
Appendix B: Warranty summary	95
Appendix C: Contact SIGLENT.....	96

Chapter 1 Quick Start

This chapter guides users to quickly get familiar with the front and rear panels, user interface and measurement connections of the multimeter.

This chapter contains the following topics:

- **General Inspection**
- **Handle Adjustment**
- **Appearance and Size**
- **The Front Panel**
- **The Back Panel**
- **Start the Multimeter**
- **User Interface**
- **Measurement Connections**
- **To Use the Built-in Help System**

General Inspection

1. Inspect the shipping container.

Please keep the damaged container or cushioning material until the contents of the shipment have been checked for completeness and the instrument has passed both electrical and mechanical tests.

The consigner or carrier shall be liable for the damage to instrument resulting from shipment. **SIGLENT** would not be responsible for free maintenance/rework or replacement of the unit.

2. Inspect the instrument.

In case of any damage, or defect, or failure, notify your **SIGLENT** sales representative.

3. Check the accessories.

Check the accessories according to the packing list. If the accessories are incomplete or damaged, please contact your **SIGLENT** sales representative.

To adjust the Handle

Adjust the handle position of SDM3065X properly to place the instrument stably so that users can manipulate and observe the display better. Please grip the handle by the two sides and pull it outward. Then rotate the handle to the appropriate position. Please operate as the following diagram.

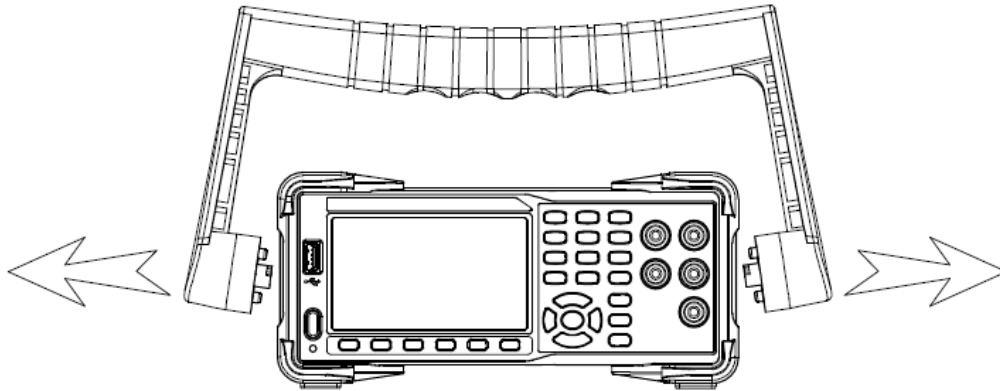

Diagram 1- 1 Handle adjustment

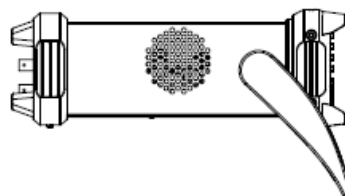
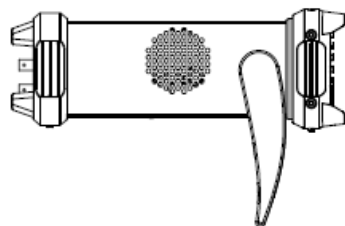
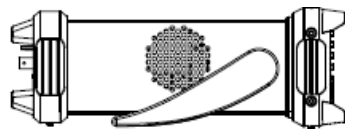

Diagram 1- 2 Horizontal Position

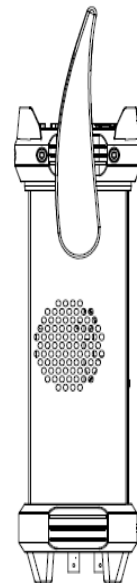

Diagram 1- 3 Carrying Position

Appearance and Size

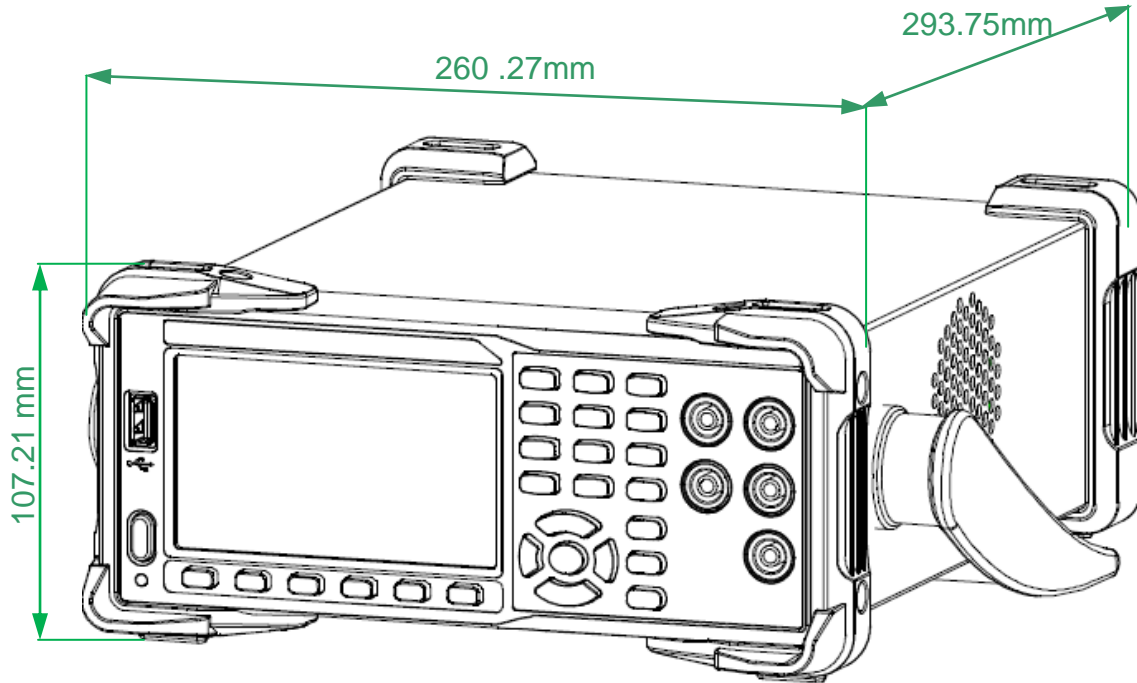

Diagram 1- 4 Appearance and Size

Front Panel

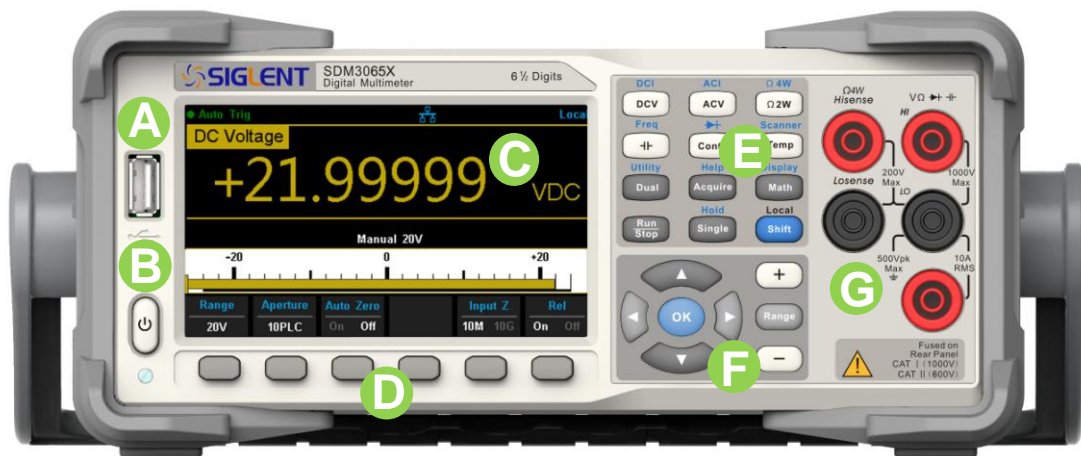

Diagram 1- 5 Front Panel Overview

A USB Host

By using this interface, users can store the current state or measurement data into USB storage device. Users can also read the state files or updated firmware from USB storage device.

B Power Key

Long/short press the key to turn on/off the instrument.







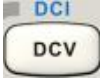
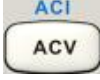
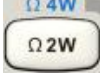

C LCD Display

The instrument provides a 4.3 inch color TFT-LCD display screen with 480*272 high resolutions that can the current function menus, measurement parameter settings, system status, prompt messages and so on.

D Menu Operation Keys

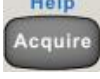
Press any softkey to activate the corresponding menu.

E Measurement and Assistant Function Keys

	<p>DC Voltage /Current Measurement</p>
	<p>AC Voltage/ Current Measurement</p>
	<p>2-Wire /4-Wire Resistance Measurement</p>
	<p>Frequency /Capacitance Measurement</p>
	<p>Continuity /Diode Test</p>
	<p>Temperature Measurement/ Enable Multiple Scan Card Function</p>
	<p>Enable Dual-display Function /Set Up the Utility</p>
	<p>Acquire Function /Help System</p>
	<p>Math Function /Display Function</p>
	<p>Auto Trigger/ Stop</p>
	<p>Single Trigger/ Hold Measurement Function</p>
	<p>Return to local control of the instrument (when in Remote mode). Some of the front panel keys have text above them. This indicates that the key has a function that you can access by pressing and releasing [Shift] before pressing the key.</p>

F Range and Direction Keys



Increase the measurement range



Decrease the measurement range



Select auto or manual range



Set up measurement parameter

Move the cursor



Page or down



Set up measurement parameter

Move the cursor



Apply the current setting

G Signal Input Terminals

The measured signal (device) will be connected into the multimeter through these terminals. Different measurement objects have different connection methods. For details, please refer to “**Measurement Connections**”.

Back Panel

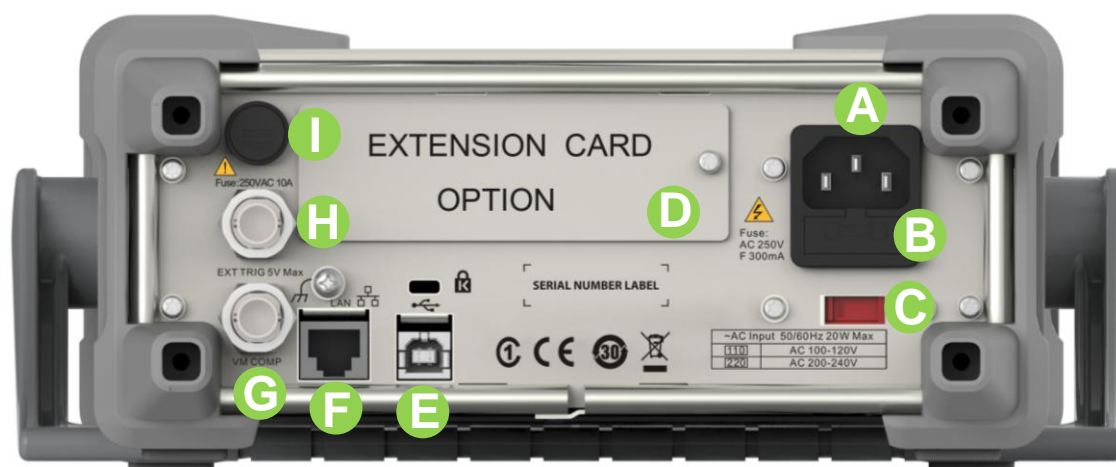

Diagram 1- 6 Back Panel Overview

A Power Socket

The multimeter accepts two types of AC supplies. Please use the power cord provided in the accessories to connect the multimeter to the AC power through this socket.

Note: a proper voltage scale must be first selected (through the Voltage Selector) before power connection.

B Power Fuse

The multimeter is already installed with a power fuse before leaving factory. To replace a new one, please:

- 1) Turn off the multimeter and remove the power cord.
- 2) Press down the block tongue using a straight screwdriver (in the direction of the dotted arrow in the figure below) and pull out of the fuse seat.
- 3) Select a proper voltage scale.
- 4) Replace a specified fuse.
- 5) Reinstall the fuse seat into the slot.

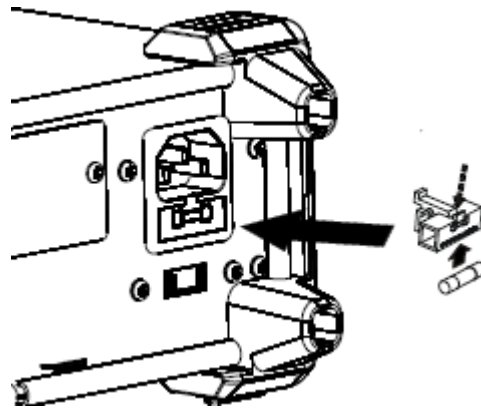

Diagram 1-7 Change the fuse

C AC Voltage Selector

Select a proper voltage scale (110 V or 220 V) according to the AC supply used.

D Inspection card (option)

An optional 16-channel Data Acquisition Module can be installed in the instrument.

E USB Device

Connect the PC through this interface. You can use SCPI commands or PC software to control SDM3065X remotely.

F LAN

Through this interface, the multimeter can be connected to the network for remote control.

G VMC Output

The multimeter outputs a low-triangular pulse from the [VM Comp] connector after every measurement

H Ext trigger

Trigger the multimeter by connecting a trigger pulse through the [Ext

Trig] connector. Note the external trigger source must be selected.

I Current Input Fuse

The multimeter is already installed with a current Input fuse to provide 10 A maximum input protection before leaving factory. To replace a new one, please:

- 1) Turn off the multimeter and remove the power cord.
- 2) Turn the fuse seat counterclockwise as shown in the figure using a straight screw driver and then pull out the fuse seat
- 3) Place a new specified fuse.
- 4) Reinstall the fuse seat into the slot.

J Instrument Lockhole

You can use the safety lock to lock the multimeter in a fixed place if necessary.

Start the Multimeter

Before connect the instrument to a power source, please select the AC voltage selector on the rear panel of your multimeter according to the power supply. Then connect the power cord as shown in the following figure.

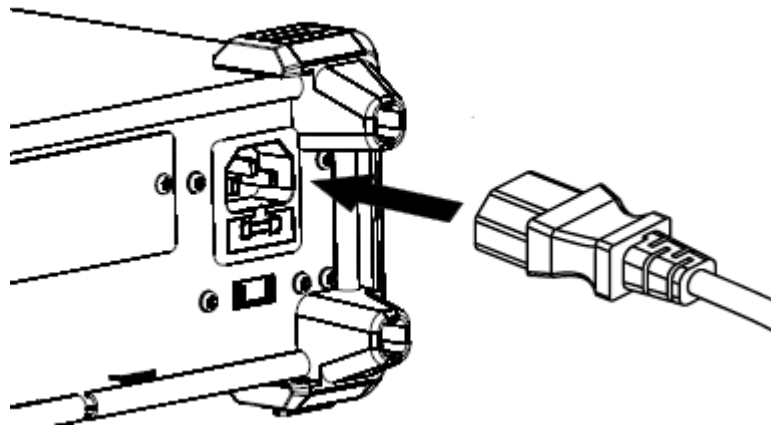

Diagram 1- 8 Connect Power Cord

Press the Power key on the front panel to start up the multimeter. If the multimeter does not start normally, please:

1. Make sure the power cord is in good connection.
2. Try to restart the multimeter, if it fails, check the power fuse and replace a new one when necessary.
3. If the problem still remains, please contact **SIGLENT**.

User Interface

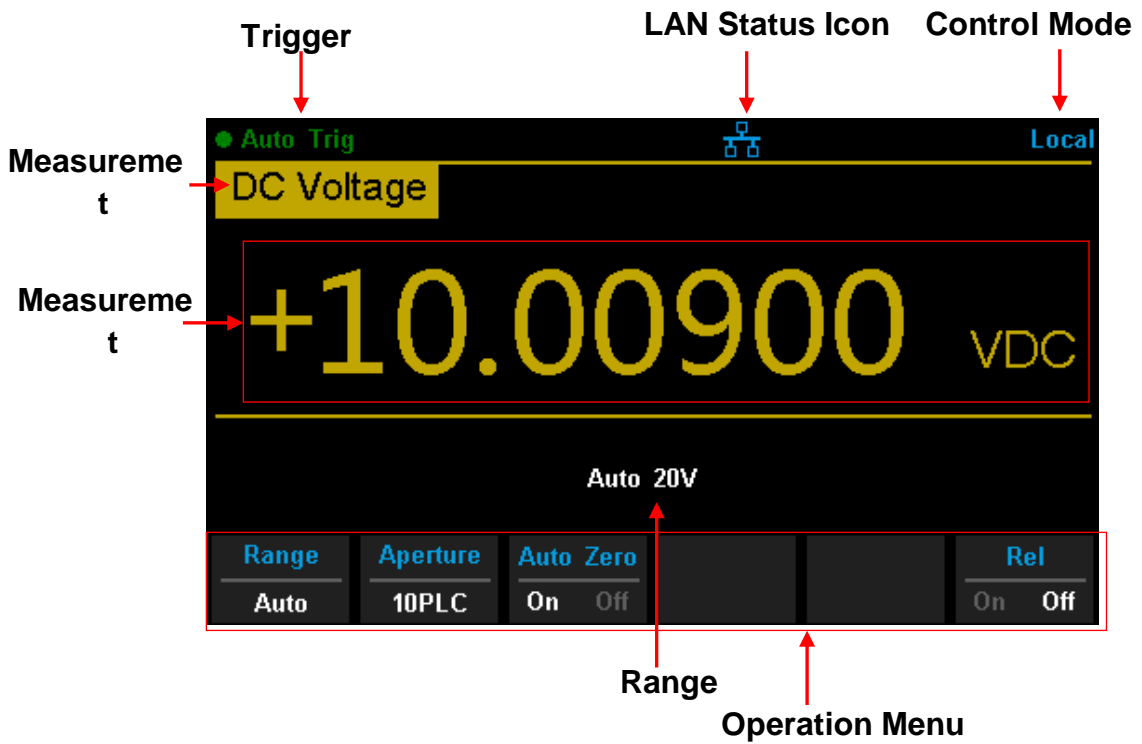
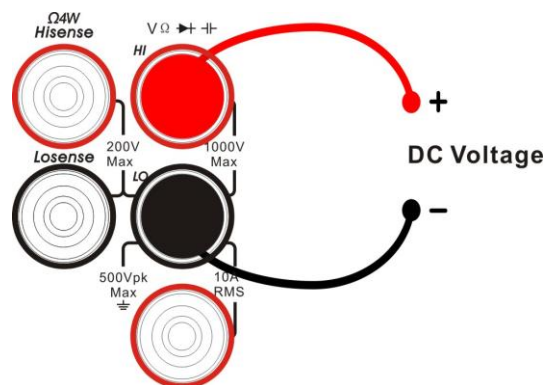

Diagram 1- 9 User Interface

Measurement Connections

SDM3065X is designed with many measurement functions. After selecting the desired measurement function, please connect the signal (device) under test to the multimeter according to the method below. Do not discretionarily switch the measurement function when measuring as it may cause damage to the multimeter. For example, when the test leads are connected to the related current terminals, AC voltage measurement should not be taken.

DCV Measurement



ACV Measurement

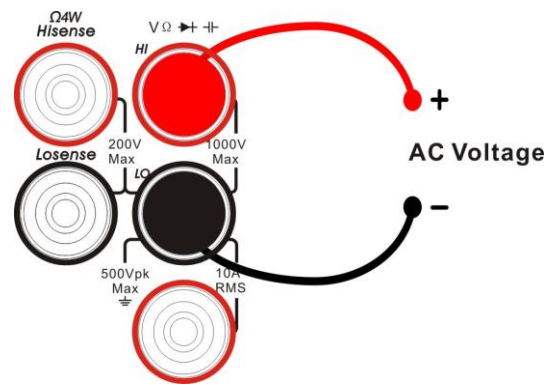

DCI Measurement

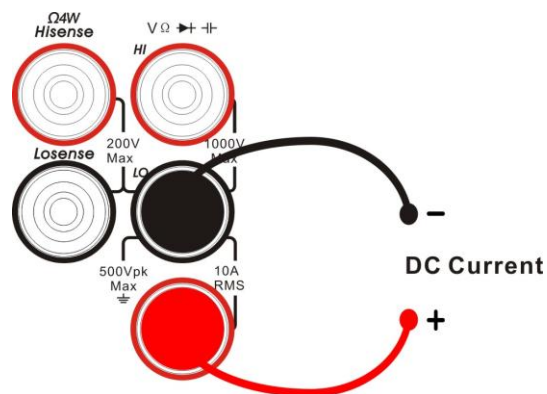

ACI Measurement

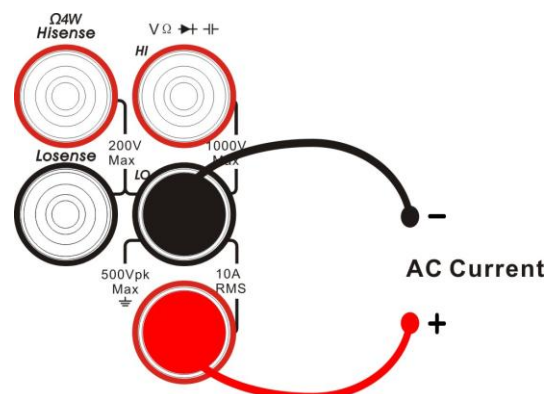

Resistance Measurement (2-wire)

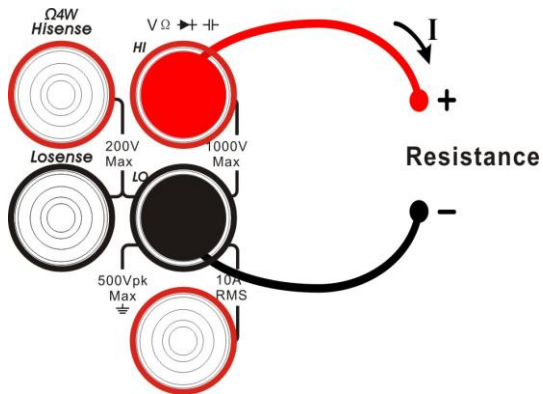

Resistance Measurement

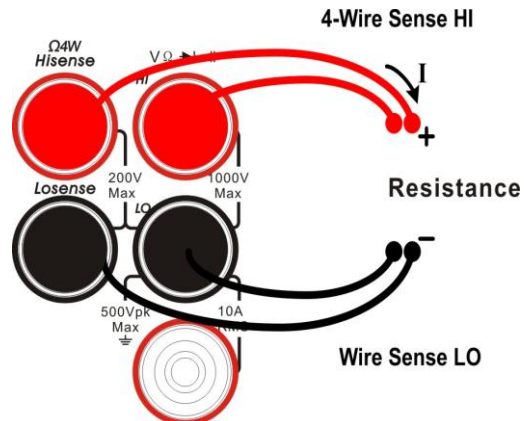

Capacitance Measurement

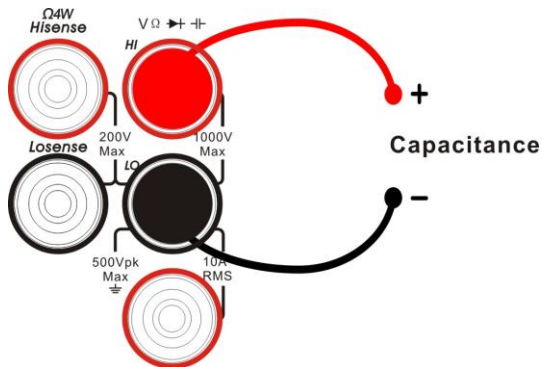

Frequency/Period Measurement

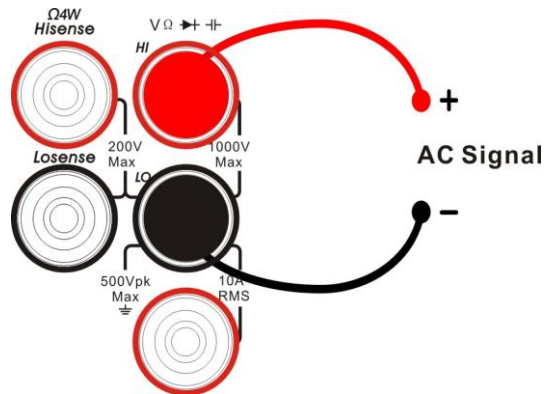

Continuity Measurement

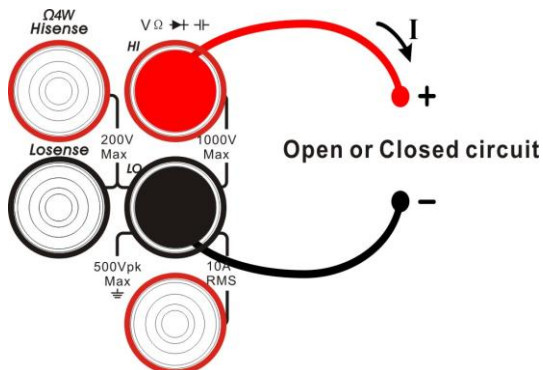

Diode Measurement

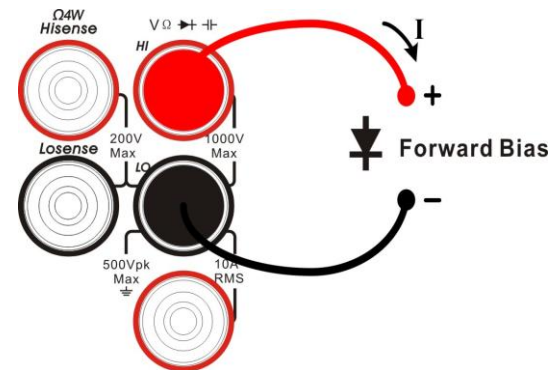

Temperature Measurement (For RTD and thermocouple sensors)

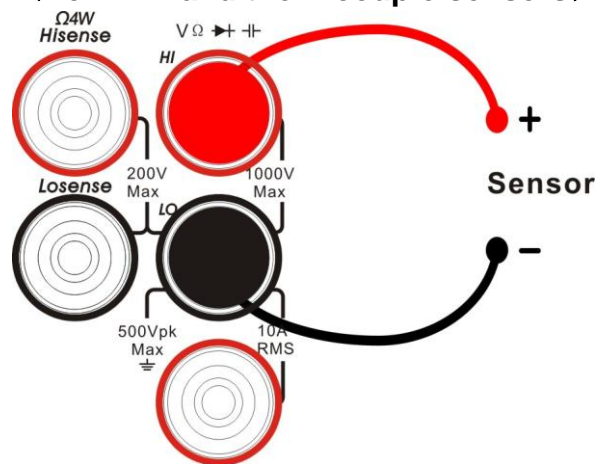

To Use the Built-in Help System

To obtain built-in help information of the product, please press **【shift】** + **【Acquire】** to enter help system, then use the direction keys to choose the help item you want, finally press **【OK】** to obtain help information

The common help information is listed as the following:

1. Basic Measure.
2. Measuring Temperature.
3. Measuring Capacitance.
4. Math Function.
5. Dual-display Function.
6. Saving and Recalling Information.
7. Optional Multiple Scan Card.
8. The convention and Tips of Softkeys.
9. Technical Support.

Chapter 2 Function and Operation

This chapter introduces how to use the functions of the multimeter from the front panel. The chapter contains the following topics:

- **To Set the Range**
- **To Set the Resolution**
- **Basic Measurement Functions**
- **Any Sensor Measurement**
- **Preset Mode**
- **Secondary Function Key**
- **Measurement Configuration**
- **Math Operations**
- **Trigger**
- **Save and Recall**
- **Utility**

Measurement Configuration

Most measurement parameters are user-defined. Changing a measurement parameter will change the measurement precision and speed as well as the input impedance. An appropriate measurement parameter based on the actual application will ensure faster measurement or higher measurement precision.

The default measurement configurations of the multimeter can ensure the accuracy of the measurement results in most cases. Users can directly use these defaults for any measurement or modify the parameters of the measurement function as required.

The parameters for different measurement function differ, see table below.

Table 2-1 Measurement parameter

Functions	Parameters
DCV	Range, Integration Time, DC impedance, Auto zero
ACV	Range, AC filter
DCI	Range, Integration Time, Auto zero
ACI	Range, AC filter
OHM (2WR、4WR)	Range, Integration Time, Auto zero
CAP	Range
CONT	Short-circuit resistance
DIODE	Breakover voltage
FREQ/PREIOD	Gate time
TEMP	N/A

Range

SDM3065X provides auto and manual range selecting modes. In auto mode, the multimeter selects a proper range automatically according to the input signal; in manual mode, you can use the front panel key or menu key to set the range. The auto mode can bring a lot of convenience for users while the manual mode provides higher reading precision.

Method 1: use the front panel key to set the range

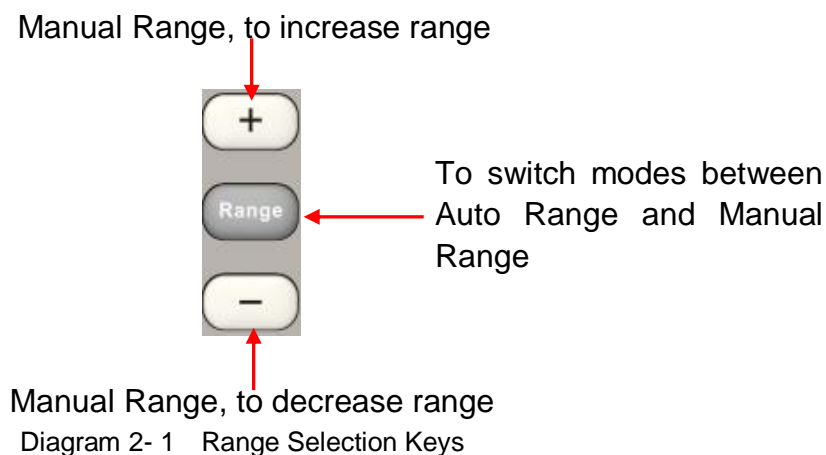

Method 2: use the menu key to select the range

Enter the specific measurement function and select **【Range】** in the menu to show the range setting options, as shown in Diagram 2-2 (take DCV measurement for instance). Then press the menu operation key to activate the corresponding configuration.

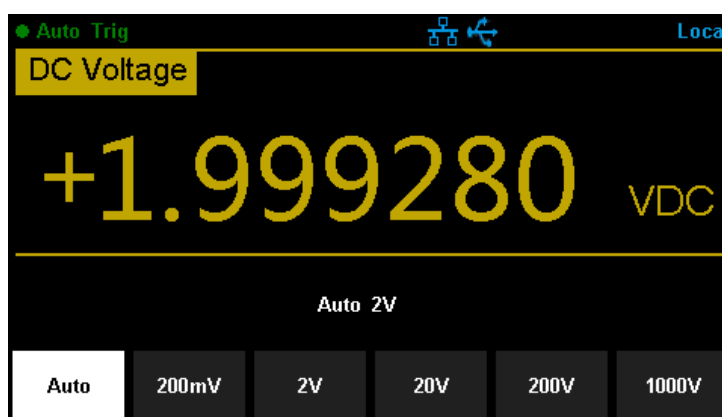

Diagram 2- 2 Range selection menu

Note:

1. “**overload**” will be displayed when the input signal exceeds the current range.
2. By default, the range is set to Auto at power-on or after a reset.
3. Auto mode is recommended if you are not sure about the measurement range in order to protect the instrument and obtain accurate data.
4. The range of CONT measurement is fixed at 2 k Ω .

Intergration Time and Resolution

Integration time is the period during which the multimeter's analog-to-digital (A/D) converter samples the input signal for a measurement. The longer the integration time is, the slower the measurement speed will be and the higher the resolution will be; the shorter the integration time is, the faster the measurement will be and the lower the resolution will be. The integration time applies to DCV, DCI, 2WR and 4WR measurements.

SDM3065X express the integration time by the power line cycles, the unit is PLC. The multimeter automatically detects the input power frequency at power-on. If the frequency is 50Hz, the intergration time can be set to 0.005PLC, 0.05 PLC, 0.5 PLC, 1 PLC, 10 PLC, 100 PLC and the default is 10 PLC. If the frequency is 60Hz, the intergration time can be set to 0.006PLC, 0.06 PLC, 0.6 PLC, 1 PLC, 10 PLC, 100 PLC and the default is 10 PLC .

SDM3065X holds reading resolutions of 4½, 5½ and 6½ digits. It automatically selects a reading resolution according to the current measurement settings.

1. In DCV, DCI and OHM measurements, press **【Aperture】** to set the intergration time, as shown in Diagram 2-5 (take DCV measurement for instance). The integration time affects the resolution.

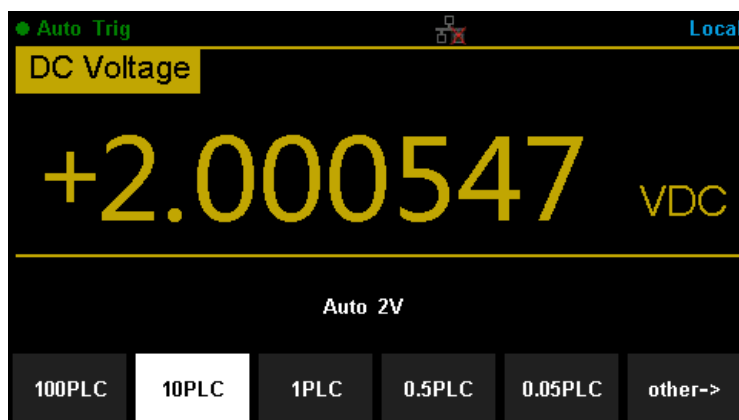

Diagram 2- 3 Intergration time selection menu

Table 2-2 Relationship between reading resolution and integration time

Resolution	Integration time
4½	0.005 PLC / 0.006PLC 0.05 PLC / 0.06PLC
5½	0.5 PLC / 0.6PLC
6½	1 PLC 10 PLC 100C

2. In ACV, ACI ,FREQ/PERIOD measurements, the resolution is fixed at 6½ digits.
3. In CAP measurements, the resolution is fixed at 4½
4. The instrument always displays 2 digit after the decimal point in CONT measurement.
5. In DIODE measurements, the resolution is fixed at 5½.
6. In TEMP measurements, the resolution is fixed at 5½.

DC Impedance

DC impedance applies to DCV measurement. The default is “10MΩ”. In the range of 200 mV, 2 V or 20 V, you can choose “>10GΩ” to reduce the loading error to the measured object caused by the multimeter

In the range of 200 mV, 2 V or 20 V under DCV measurement, press **【Input Z】** in the menu to perform the setting, as shown in Diagram 2-4.

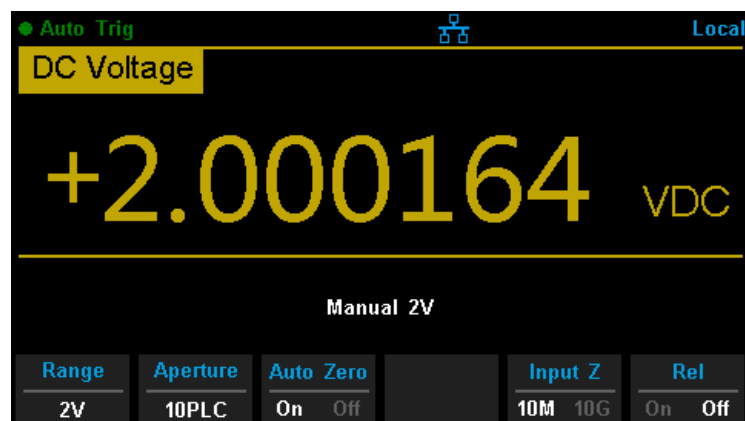

Diagram 2-4 Choose DC Input Impedance

- **10MΩ**: set the input impedances in all ranges to 10 MΩ.
- **10GΩ**: set the input impedances in ranges of 200 mV, 2 V and 20 V to 10 GΩ, while in ranges of 200 V and 1000 V, the impedances are still 10 MΩ.

Auto Zero

Auto zero (Auto Zero) applies to DCV, DCI, 2WR and 4WR measurements.

Enter the specific measurement function and press **【Auto Zero】** in the menu to perform the setting, as shown in Diagram 2-5 (take DCV measurement for instance).

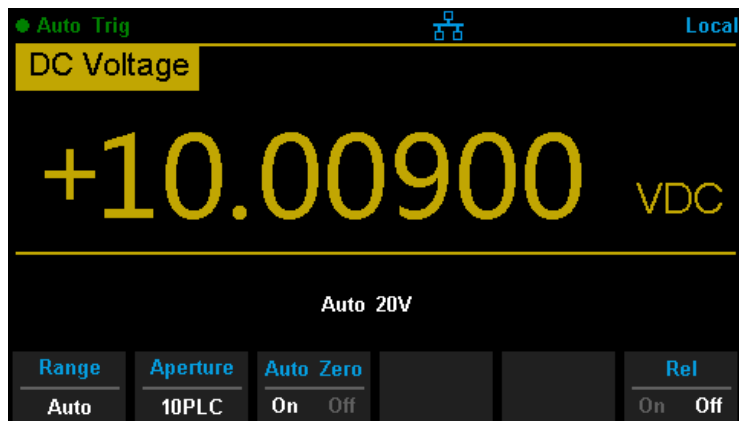

Diagram 2-5 Turn on or off Auto Zero

- **ON:** the multimeter internally disconnects the input signal and measured circuit after each measurement, and takes a zero reading. It then subtracts the zero reading from the preceding reading (displaying the difference between the measurement value and zero value during the measurement), in order to reduce the impact of offset voltage from input circuit on measurement result.
- **OFF:** disable the auto zero function.

AC Filter

AC filter applies to ACV and ACI measurements. It can optimize the low-frequency accuracy and minimize the AC settling time. SDM3065X provides three types of AC filters (>3Hz, >20Hz, >200Hz).

The AC filter to be used is determined by the input signal frequency. You should generally select the highest frequency filter whose frequency is less than that of the signal you are measuring, because higher frequency filters result in faster measurements. For example, when measuring a signal between 20 and 200 Hz, use the 20 Hz filter. If measurement speed is not an issue, choosing a lower frequency filter may result in quieter measurements, depending on the signal that you are measuring.

Press **【Filter】** in the menu of ACV or ACI measurement to show the setting options, as shown in Diagram 2-6 (take ACV measurement for instance). Then press the menu operation key to activate the corresponding configuration.

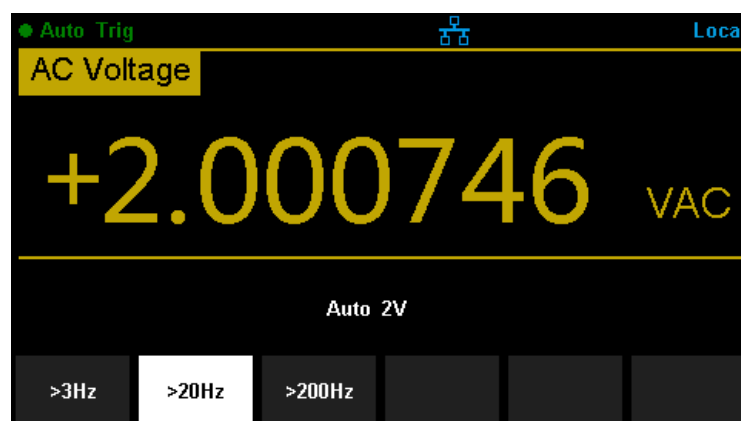

Diagram 2-6 AC Filter setting interface

Short-circuit Resistance

This function only applies to continuity test. When the measured circuit has a resistance lower than the short-circuit resistance, the circuit is considered as connected, and the beeper sounds (if sound is on). The default short-circuit resistance is 50 Ω and the setting is stored in nonvolatile memory.

When continuity test is enabled, Set the **【Threshold】** (equal to short-circuit resistance) using the direction keys. The range is from 1 Ω to 2000 Ω .

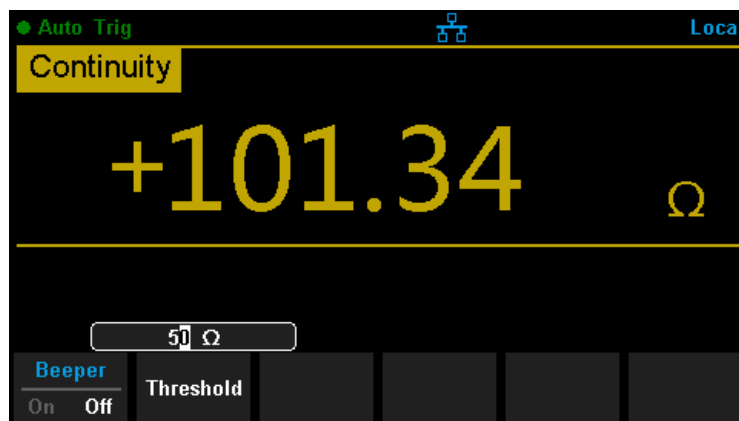

Diagram 2- 7 Set Up the Short-circuit Resistance

Gate Time

Gate time (also called Aperture Time) applies to FREQ/PERIOD function. It decides the resolution of low-frequency measurement. The longer the gate time is, the higher the resolution of the low-frequency measurement is and the slower the measurement is, and vice versa.

In FREQ/PERIOD measurement, press **【Gate Time】** to show the setting options, as shown in Diagram 2-8 (take FREQ measurement for instance). The gate time can be set to 1 ms, 10 ms, 100 ms or 1 s and the default is 100 ms. You can select a desired gate time by pressing the corresponding softkey.

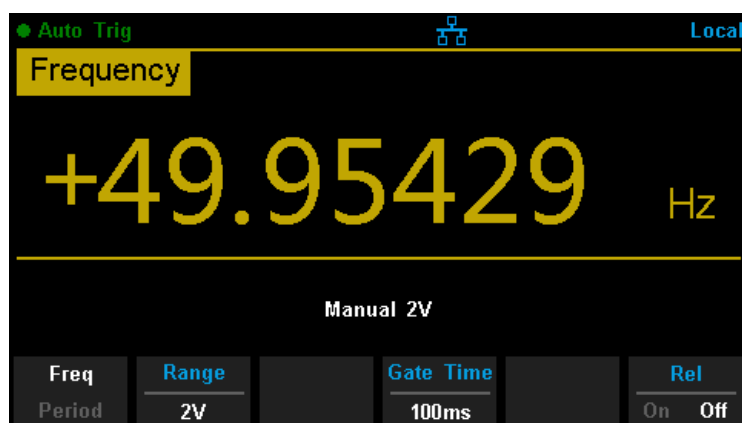

Diagram 2- 8 Set Up the Gate Time

Basic Measurement Functions

SDM3065X Digital Multimeters have following basic functions:

- **To Measure DC Voltage**
- **To Measure AC Voltage**
- **To Measure DC Current**
- **To Measure AC Current**
- **To Measure 2/4-Wire Resistance**
- **To Measure Capacitance**
- **To Test Continuity**
- **To Test Diode**
- **To Measure Frequency or Period**
- **To Measure Temperature**

To Measure DC Voltage

Range: 200mV, 2V, 20V, 200V, 1000V

Max Resolution: 100nV (in the range of 200mV)

Input Protection: a 1000 V protection is available in all ranges and a 10% overrange for all ranges except 1000 V range. If the reading exceeds the range, “**overload**” will be displayed.

Operating Steps:

1. Enable the DCV measurement

Press  on the front panel to enter the DC Voltage measurement interface, as shown in Diagram 2- 9.

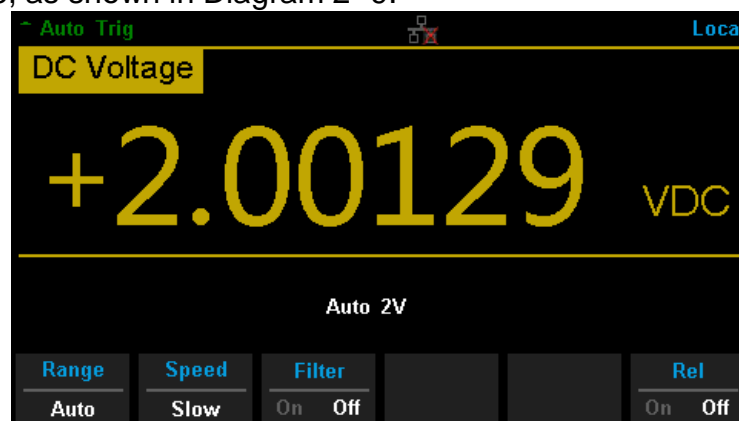





Diagram 2- 9 DC Voltage Measurement Interface

2. Make connection

Connect the test leads with the measured signal by referring to “**Measurement Connections**”.

3. Set the range

Press **【Range】** to select a range for the measurement. You can also use the , , and  keys on the front panel to select the range.

Auto (autorange) automatically selects the range for the measurement based on the input. Autoranging is convenient, but it results in slower measurements than using a manual range. Autoranging goes up a range at 110% of the present range, and down a range below 10% of the present range.

4. Set the intergration

Press **【Aperture】** and choose the number of power-line cycles (PLCs) to use for the measurement. Selecting 100 PLC provides the best noise rejection and resolution, but the slowest measurements

5. Autozero setting

Press **【Auto Zero】** to enable or disable this function. Autozero provides the most accurate measurements, but requires additional time to perform the zero measurement. With autozero enabled (On), the DMM internally measures the offset following each measurement. It then subtracts that measurement from the preceding reading. This prevents offset voltages present on the DMM's input circuitry from affecting measurement accuracy.

6. Specify the DC input impedance (Only for Manual 200mV, 2V and 20V ranges)

Press **【Input Z】** to set the DC resistance as "10M" (default value) or "10G". Users can execute DC voltage measurement directly without modifying this parameter which has been setup before leaving factory.

7. Set the relative value (Optional operation)

Press **【Rel】** to open or close Relative math function. When it is opened, the reading displayed is a value which comes from the result of actual measurement value subtracts the relative value that has been set. The default relative value is the measurement value when the function is opened. (Please refer to "Math Functions" in Chapter 2 to know about the details.)

8. Read the measurement value

The multimeter measures the input signal according to the current measurement settings and displays the measurement result on the screen.

9. Make math operation (advanced)

You can perform math operation (Statistics, Limit, dBm, dB and REL) on every DCV measurement reading. For details, please refer to "Math Operations".

10. Display the graph (advanced)



You can analyze the measurement data by using "Bar Meter", "Trend Char" or "Histogram display". For details, please refer to "**Display Mode**".

To Measure DC Current

Range: 200 μ A, 2 mA, 20 mA, 200 mA, 2A, 10A
Max Resolution: 0.1nA (in the range of 200 μ A)
Input Protection: a 10A protection is available in all ranges and a 10% overrange for all ranges except 10A range. If the reading exceeds the range, “**overload**” will be displayed.

Operating Steps:

1. Enable the DCI measurement

Press  and  on the front panel to enter the DC Current measurement interface, as shown in Diagram 2- 10.

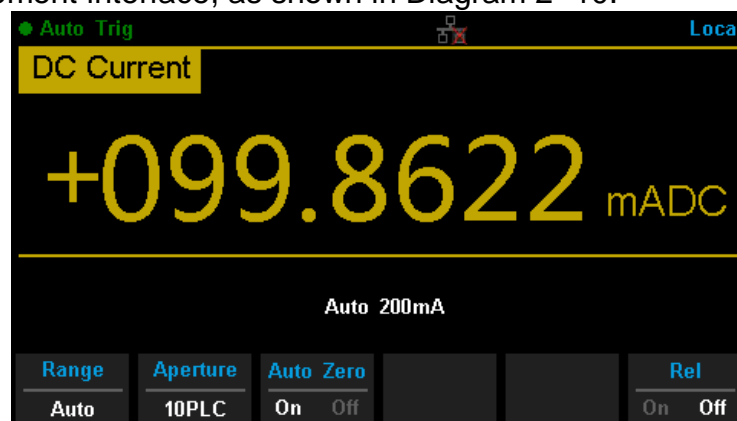





Diagram 2- 10 DC Current Measurement Interface

2. Make connection

Connect the test leads with the measured signal by referring to “**Measurement Connections**”.

3. Set the range

Press **【Range】** to select a range for the measurement. You can also use the , , and  keys on the front panel to select the range.

Auto (autorange) automatically selects the range for the measurement based on the input. Autoranging is convenient, but it results in slower measurements than using a manual range. Autoranging goes up a range at 110% of the present range, and down a range below 10% of the present range.

4. Set the intergration Time

Press **【Aperture】** and choose the number of power-line cycles (PLCs) to use for the measurement. Selecting 100 PLC provides the best noise rejection and resolution, but the slowest measurements

5. Autozero setting

Press **【Auto Zero】** to enable or disable this function. Autozero provides the most accurate measurements, but requires additional time to perform the zero measurement. With autozero enabled (On), the DMM internally measures the offset following each measurement. It then subtracts that measurement from the preceding reading. This prevents offset voltages present on the DMM's input circuitry from affecting measurement accuracy.

6. Set the relative value (Optional operation)

Press **【Rel】** to open or close Relative math function. When it is opened, the reading displayed is a value which comes from the result of actual measurement value subtracts the relative value that has been set. The default relative value is the measurement value when the function is opened. (Please refer to "Math Functions" in Chapter 2 to know about the details.)

7. Read the measurement value

The multimeter measures the input signal according to the current measurement settings and displays the measurement result on the screen.

8. Make math operation (advanced)

You can perform math operation (Statistics, Limit and REL) on every DCI measurement reading. For details, please refer to "**Math Operations**".

9. Display the graph (advanced)

You can analyze the measurement data by using "Bar Meter", "Trend Char" or "Histogram display". For details, please refer to "**Display Mode**".

To Measure AC Voltage

Range: 200mV, 2V, 20V, 200V, 750V

Max Resolution: 100nV (in the range of 200mV)

Input Protection: a 750 V protection is available in all ranges and a 10% overrange for all ranges except 750 V range. If the reading exceeds the range, “**overload**” will be displayed.

Operating Steps:

1. Enable the ACV measurement

Press  on the front panel to enter the AC Voltage measurement interface, as shown in Diagram 2- 11.

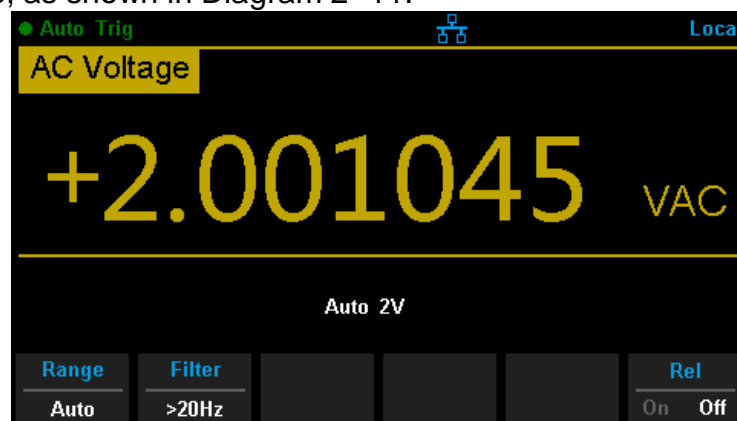





Diagram 2- 11 AC Voltage Measurement Interface

2. Make connection

Connect the test leads with the measured signal by referring to “**Measurement Connections**”.

3. Set the range

Press **【Range】** to select a range for the measurement. You can also use the , , and  keys on the front panel to select the range.

Auto (autorange) automatically selects the range for the measurement based on the input. Autoranging is convenient, but it results in slower measurements than using a manual range. Autoranging goes up a range at 110% of the present range, and down a range below 10% of the present range.

4. Set the filter

Press **【Filter】** and choose the filter for the measurement. The instrument provides three different AC filters --“>3Hz”, “>20Hz” and “>200Hz”. You should generally select the highest frequency filter whose frequency is less than that of the signal you are measuring,

5. Set the relative value (Optional operation)

Press **【Rel】** to open or close Relative math function. When it is opened, the reading displayed is a value which comes from the result of actual measurement value subtracts the relative value that has been set. The default relative value is the measurement value when the function is opened.(Please refer to “ Math Functions” in Chapter 2 to know about the details.)

6. Read the measurement value

The multimeter measures the input signal according to the current measurement settings and displays the measurement result on the screen.

7. Make math operation (advanced)

You can perform math operation (Statistics, Limit, dBm, dB and REL) on every ACV measurement reading. For details, please refer to “Math Operations”.

8. Display the graph (advanced)



You can analyze the measurement data by using “Bar Meter”, “Trend Char” or “Histogram display”. For details, please refer to “**Display Mode**”.

To Measure AC Current

Range: 200 μ A, 2 mA, 20 mA, 200 mA, 2A, 10A
Max Resolution: 0.1nA (in the range of 200 μ A)
Input Protection: a 10A protection is available in all ranges and a 10% overrange for all ranges except 10A range. If the reading exceeds the range, “**overload**” will be displayed.

Operating Steps:

1. Enable the ACI measurement

Press  and  on the front panel to enter the AC current measurement interface, as shown in Diagram 2- 12.

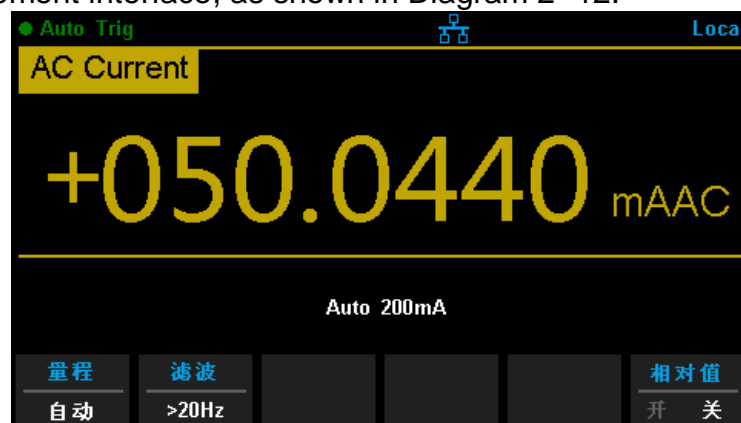





Diagram 2- 12 AC Current Measurement Interface

2. Make connection

Connect the test leads with the measured signal by referring to “**Measurement Connections**”.

3. Set the range

Press **【Range】** to select a range for the measurement. You can also use the , , and  keys on the front panel to select the range. Auto (autorange) automatically selects the range for the measurement based on the input. Autoranging is convenient, but it results in slower measurements than using a manual range. Autoranging goes up a range at 110% of the present range, and down a range below 10% of the present range.

4. Set the filter

Press **【Filter】** and choose the filter for the measurement. The instrument provides three different AC filters --“>3Hz”, “>20Hz” and “>200Hz”. You should generally select the highest frequency filter whose frequency is less than that of the signal you are measuring,

5. Set the relative value (Optional operation)

Press **【Rel】** to open or close Relative math function. When it is opened, the reading displayed is a value which comes from the result of actual measurement value subtracts the relative value that has been set. The default relative value is the measurement value when the function is opened.(Please refer to “ Math Functions” in Chapter 2 to know about the details.)

6. Read the measurement value

The multimeter measures the input signal according to the current measurement settings and displays the measurement result on the screen.

7. Make math operation (advanced)

You can perform math operation (Statistics, Limit and REL) on every ACI measurement reading. For details, please refer to “Math Operations”.

8. Display the graph (advanced)

You can analyze the measurement data by using “Bar Meter”, “Trend Char” or “Histogram display”. For details, please refer to “**Display Mode**”.

To Measure Resistance

Range: 200 Ω , 2k Ω , 20k Ω , 200k Ω , 1M Ω , 10M Ω , 100M Ω

Max Resolution: 100 $\mu\Omega$ (in the range of 200 Ω)

Input Protection: a 1000 V protection is available in all ranges and a 10% overrange for all ranges. If the reading exceeds the range, “**overload**” will be displayed.

SDM3065X provides 2-wire and 4-wire resistance measurements. When the measured resistance is lower than 100 k Ω , the 4-wire resistance measurement is recommended to reduce the measurement error caused by test lead resistance and contact resistance between the probe and the testing point because these two resistances cannot be ignored any more, compared to the measured resistance.

Operating Steps:

1. Enable 2-wire / 4-wire resistance measurement

Press  on the front panel to enter the 2-wire resistance measurement interface, as shown in Diagram 2- 13.

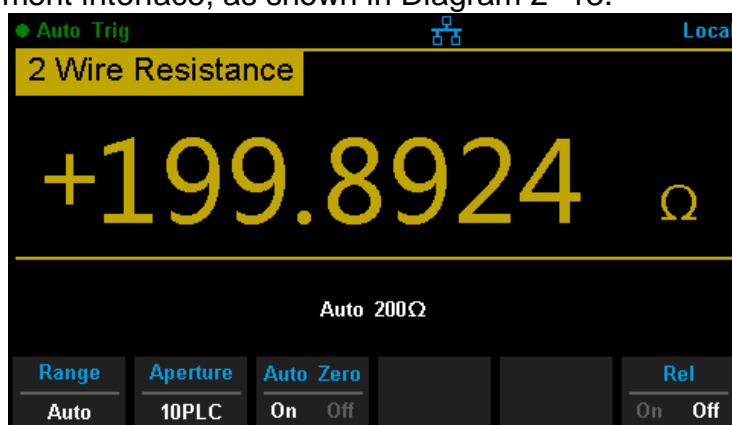



Diagram 2- 13 2 Wire Resistance Measurement Interface

Press  and  on the front panel to enter the 4-wire resistance measurement interface, as shown in Diagram 2- 14.

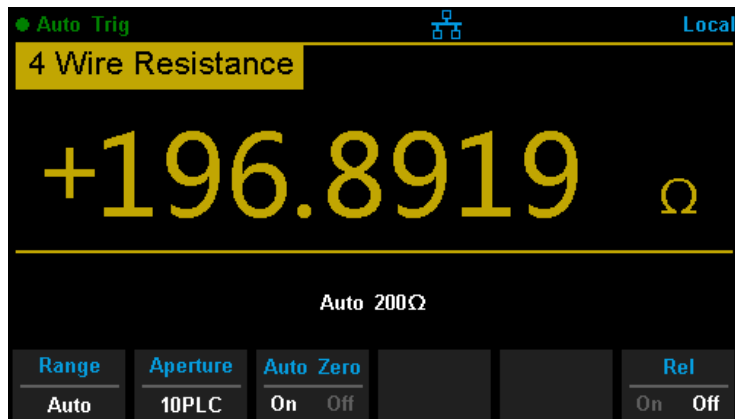

Diagram 2- 14 4 Wire Resistance Measurement Interface

2. Make connection

Connect the test leads with the measured signal by referring to “**Measurement Connections**”.

3. Set the range

Press **【Range】** to select a range for the measurement. You can also use the **+**, **-**, and **Range** keys on the front panel to select the range.

Auto (autorange) automatically selects the range for the measurement based on the input. Autoranging is convenient, but it results in slower measurements than using a manual range. Autoranging goes up a range at 110% of the present range, and down a range below 10% of the present range.

4. Set the intergration

Press **【Aperture】** and choose the number of power-line cycles (PLCs) to use for the measurement. Selecting 100 PLC provides the best noise rejection and resolution, but the slowest measurements

5. Autozero setting

Press **【Auto Zero】** to enable or disable this function. Autozero provides the most accurate measurements, but requires additional time to perform the zero measurement. With autozero enabled (On), the DMM internally measures the offset following each measurement. It then subtracts that measurement from the preceding reading. This prevents offset voltages present on the DMM’s input circuitry from affecting measurement accuracy.

6. Set the relative value (Optional operation)

Press **【Rel】** to open or close Relative math function. When it is opened,

the reading displayed is a value which comes from the result of actual measurement value subtracts the relative value that has been set. The default relative value is the measurement value when the function is opened.(Please refer to “ Math Functions” in Chapter 2 to know about the details.)

7. Read the measurement value

The multimeter measures the input signal according to the current measurement settings and displays the measurement result on the screen.

8. Make math operation (advanced)

You can perform math operation (Statistics, Limit and REL) on every resistance measurement reading. For details, please refer to “Math Operations”.

9. Display the graph (advanced)

You can analyze the measurement data by using “Bar Meter”, “Trend Char” or “Histogram display”. For details, please refer to “**Display Mode**”.

To Measure Capacitance

Range: 2nF, 20nF, 200nF, 2 μ F, 20 μ F, 200 μ F, 2mF, 20mF, 100mF
Max Resolution: 1pF (in the range of 2nF)
Input Protection: a 1000 V protection is available in all ranges. If the reading exceeds the range, “**overload**” will be displayed.

Operating Steps:

1. Enable the Capacitance measurement

Press  on the front panel to enter the Capacitance measurement interface, as shown in Diagram 2- 15.





Diagram 2- 15 Capacitance Measurement Interface

2. Make connection

Connect the test leads with the measured signal by referring to “**Measurement Connections**”.

3. Set the range

Press **【Range】** to select a range for the measurement. You can also use the , , and  keys on the front panel to select the range. Auto (autorange) automatically selects the range for the measurement based on the input. Autoranging is convenient, but it results in slower measurements than using a manual range. Autoranging goes up a range at 110% of the present range, and down a range below 10% of the present range.

4. Set the relative value (Optional operation)

Press **【Rel】** to open or close Relative math function. When it is opened,

the reading displayed is a value which comes from the result of actual measurement value subtracts the relative value that has been set. The default relative value is the measurement value when the function is opened.(Please refer to “ Math Functions” in Chapter 2 to know about the details.)

5. Read the measurement value

The multimeter measures the input signal according to the current measurement settings and displays the measurement result on the screen.

6. Make math operation (advanced)

You can perform math operation (Statistics, Limit and REL) on every ACI measurement reading. For details, please refer to “Math Operations”.

7. Display the graph (advanced)

You can analyze the measurement data by using “Bar Meter”, “Trend Char” or “Histogram display”. For details, please refer to “**Display Mode**”.

NOTE:



Please short contact the two feet of an electrolytic capacitor by using a test lead before measuring the electrolytic capacitor.

To Measure Frequency or Period

Frequency (Period) Range: From 3 Hz to 1MHz (from 0.33s to 1 μ s)
Input Signal Range: 200mV, 2V, 20V, 200V, 750V
Input Protection: a 750 V protection is available in all ranges.

Operating Steps:

1. Enable the Freq/Period measurement

Press  and  on the front panel, then select **【Freq】** to enter the frequency measurement interface, as shown in Diagram 2- 16.

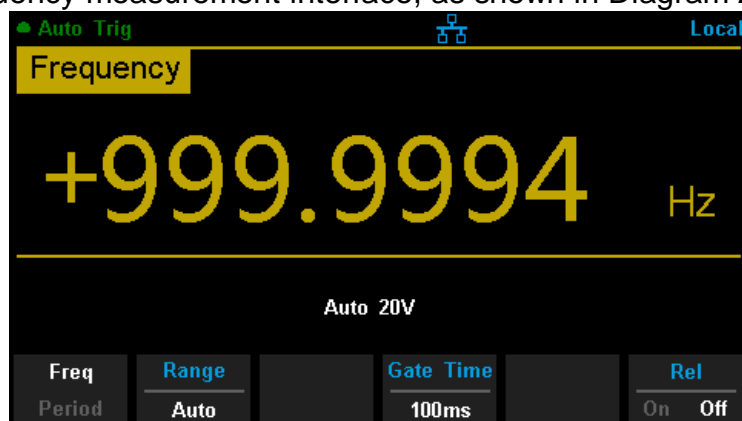

Diagram 2- 16 Frequency Measurement Interface

Select **【Period】** to enter the period measurement interface, as shown in Diagram

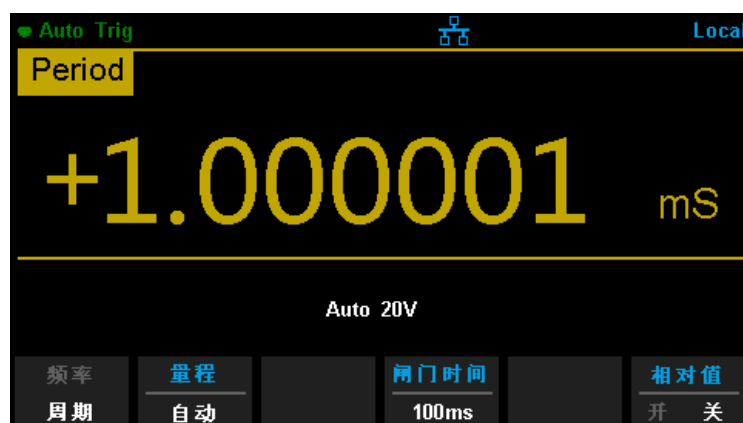





Diagram 2- 17 Period Measurement Interface

2. Make connection

Connect the test leads with the measured signal by referring to **“Measurement Connections”**.

3. Set the range

Press **【Range】** to select a range for the measurement. You can also use the , , and  keys on the front panel to select the range. Auto (autorange) automatically selects the range for the measurement based on the input. Autoranging is convenient, but it results in slower measurements than using a manual range. Autoranging goes up a range at 110% of the present range, and down a range below 10% of the present range.

4. Set the gate time

Press **【Gate Time】** and choose the measurement aperture of 1 ms , 10 ms, 100 ms (default), or 1 s.

5. Set the relative value (Optional operation)

Press **【Rel】** to open or close Relative math function. When it is opened, the reading displayed is a value which comes from the result of actual measurement value subtracts the relative value that has been set. The default relative value is the measurement value when the function is opened. (Please refer to “Math Functions” in Chapter 2 to know about the details.)

6. Read the measurement value

The multimeter measures the input signal according to the current measurement settings and displays the measurement result on the screen.

7. Make math operation (advanced)

You can perform math operation (Statistics, Limit and REL) on every measurement reading. For details, please refer to “Math Operations”.

8. Display the graph (advanced)

You can analyze the measurement data by using “Bar Meter”, “Trend Char” or “Histogram display”. For details, please refer to “Display Mode”.

To Test Continuity

Test Current Source: 1mA
Max Resolution: 0.01Ω
Input Protection: 1000V Input Protection
Open-circuit Voltage: <8V
Beep Threshold (short-circuit resistance): from 0Ω to 2000Ω

This function measures the resistance of the circuit with about 1mA current source. When the measured resistance is lower than the short-circuit resistance (Threshold), the beeper sounds (if the Beeper is on). Otherwise, “open” is displayed on the screen

Operating Steps:

1. Enable the Cont measurement

Press  on the front panel to enter the Continuity test interface, as shown in Diagram 2- 18.

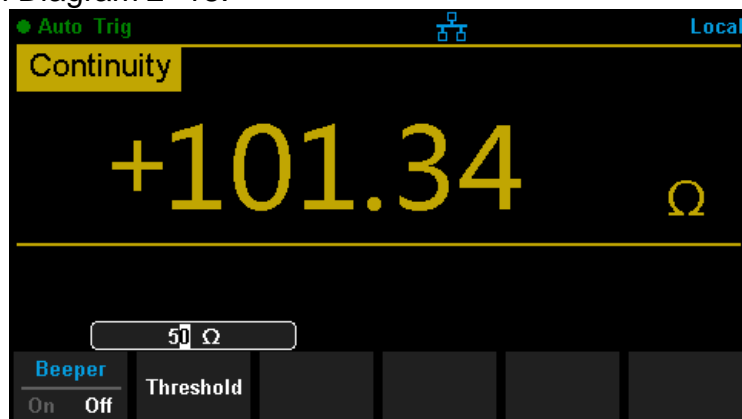

Diagram 2- 18 Continuity Measurement Interface

2. Make connection

Connect the test leads with the measured signal by referring to “**Measurement Connections**”.

3. Set the short-circuit resistance (Threshold)

Enter a desired value using the direction keys. The range is from 0 Ω to 2000 Ω and the default is 50 Ω.

4. Read the measurement value

The multimeter measures the input signal according to the current measurement settings and displays the measurement result on the screen.

5. Make math operation (advanced)

You can perform math operation (Statistics, Limit) on every measurement reading. For details, please refer to “Math Operations”.

6. Display the graph (advanced)

You can analyze the measurement data by using “Bar Meter”, “Trend Char” or “Histogram display”. For details, please refer to “**Display Mode**”.

NOTE:

Before testing continuity, please cut off the power and discharge all the high-voltage containers to avoid damages to the Multimeter.



To Test Diode

Test Current Source: 1mA
Voltage Measurement Range: 0V~4V
Max Resolution: 10 μ V
Input Protection: 1000V Input Protection
Open-circuit Voltage: <8V

This function measures the forward voltage drop on the diode. When the voltage is lower than Threshold, the beeper sounds (if the beeper is on).

Operating Steps:

1. Enable the Diode measurement

Press  and  on the front panel to enter the Diode test interface, as shown in Diagram 2- 19.

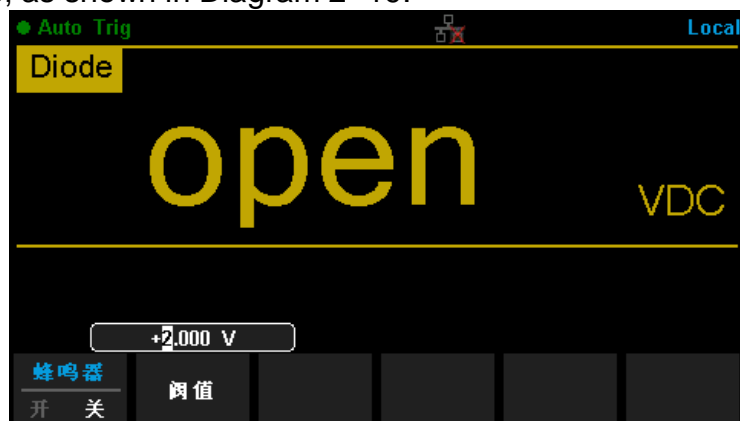

Diagram 2- 19 Diode Measurement Interface

2. Make connection

Connect the test leads with the measured signal by referring to “**Measurement Connections**”.

3. Set the Threshold

Enter a desired value using the direction keys. The range is from 0 to 4V and the default is 2V.

4. Read the measurement value

The multimeter measures the input signal according to the current measurement settings and displays the measurement result on the screen. If

the reading exceeds the threshold, “**open**” will be displayed.

5. Evaluate the results of measurement

Reverse the probes and measure the forward voltage drop on the diode again. Evaluate the diode according to the following rules:

- If the Multimeter displays “open” when in reverse bias model, it indicates that the diode is normal.
- If the Multimeter shows voltage about 0V and the instrument beeps persistently when in forward and reverse bias model, it indicates that the diode is short.
- If the Multimeter shows “open” when in forward and reverse model, it indicates that the diode is open.

6. Make math operation (advanced)

You can perform math operation (Statistics, Limit) on every measurement reading. For details, please refer to “Math Operations”.

7. Display the graph (advanced)

You can analyze the measurement data by using “Bar Meter”, “Trend Char” or “Histogram display”. For details, please refer to “**Display Mode**”.

Note:

Before testing diode, please cut off the power and discharge all the high-voltage containers to avoid damages to the Multimeter.

To Measure Temperature

SDM3065X can directly measure the temperature using TC (Thermocouple) and THERM (Thermistor) sensors.

Operating Steps:

1. Enable the Diode measurement

Press  on the front panel to enter the Temperature measurement interface, as shown in Diagram 2- 20.

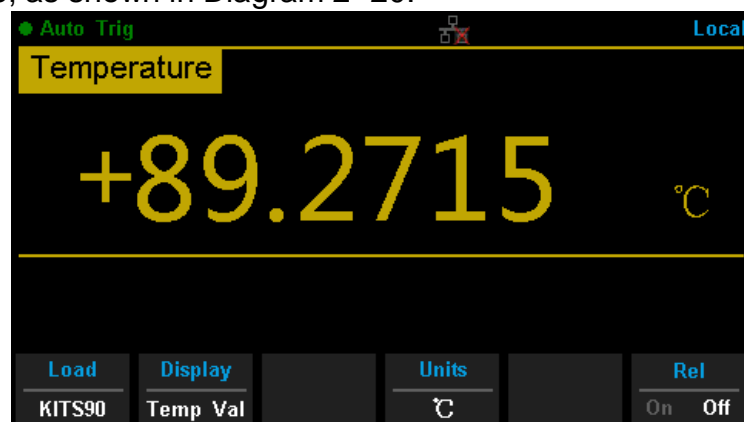

Diagram 2- 20 Temperature Measurement Interface

2. Make connection

Connect the test leads with the measured signal by referring to “**Measurement Connections**”.

3. Set the type of sensor

Press **【Load】** and use direction keys to choose a desired temperature sensor. Press **【Define】** to view the configurations .Then press **【Read】** to apply the current temperature sensor configurations.

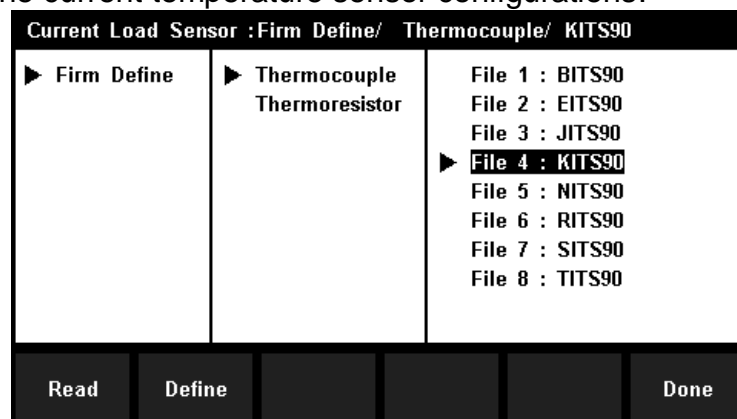

Diagram 2- 21 Load a Configuration File

4. Set the display mode

Press **【Display】** to choose the display mode. The Multimeter supports three display modes: Temperature Value, Measured Value and All (Temperature Value and Measured Value will be shown on the display together).

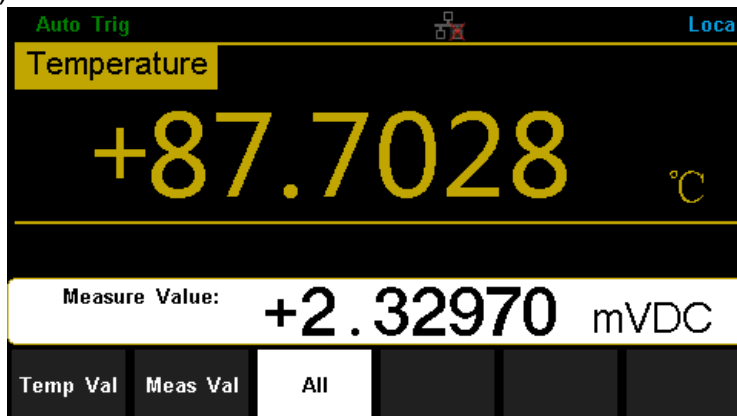

Diagram 2- 22 Choose Display Mode of Temperature Measurement

5. Set the unit of temperature

Press **【Units】** to choose the unit of temperature. The Multimeter supports three units: ° C , ° F , K.

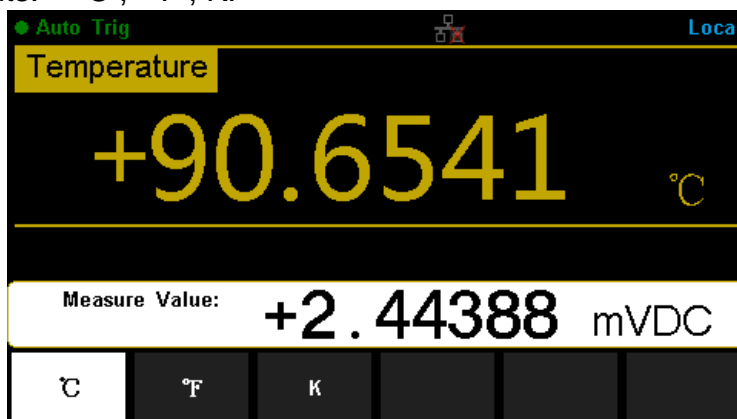

Diagram 2- 23 Unit Selection Interface

6. Set the relative value (Optional operation)

Press **【Rel】** to open or close Relative math function. When it is opened, the reading displayed is a value which comes from the result of actual measurement value subtracts the relative value that has been set. The default relative value is the measurement value when the function is opened.(Please refer to “ Math Functions” in Chapter 2 to know about the details.)

7. Read the measurement value

The multimeter measures the input signal according to the current measurement settings and displays the measurement result on the

screen.

8. Make math operation (advanced)

You can perform math operation (Statistics, Limit and REL) on every measurement reading. For details, please refer to “Math Operations”.

9. Display the graph (advanced)

You can analyze the measurement data by using “Bar Meter”, “Trend Char” or “Histogram display”. For details, please refer to “**Display Mode**”.

Dual-display Function

Dual-display function is used to improve test and measurement functions.

Press  to open Dual-display function and the upper right corner will show “Dual”. By this time, press a function key if this function can be used as the vice display, it will be displayed in the Vice Display. The Main Display will display the function that is selected before the Dual-display function is turned on. All the available combinations are listed in table 2-3.

Table 2- 3 Available Main/Vice Function Combinations (shade is available)

		Main Display Function								
		DCV	DCI	ACV	ACI	FREQ	PERIOD	2-Wire R	4-Wire R	Cap
Vice Display Function	DCV									
	DCI									
	ACV									
	ACI									
	FREQ									
	PERIOD									
	2-Wire R									
	4-Wire R									
	Cap									

For example, press  →  →  to enter the following interface

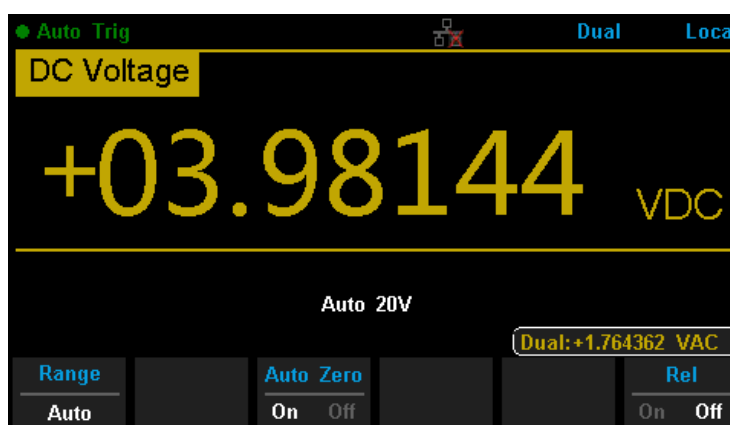



Diagram 2- 23 Dual-display Interface

Instruction:

1. If the same measurement function is used in both Main and Vice Display.
 - The readings in both of the display will update at the same time.
 - If math function (dBm, dB) is used in Main Display, when opening Vice Display, math operation will be closed automatically and Vice Display will show the same measurement result as Main Display.
 - If math function (Statistics, Limits, Relative) is used in Main Display, when opening Vice Display, the result will still be shown in Main Display and Vice Display will show the same measurement result as Main Display.

2. If different measurement functions are used in both Main and Vice Display.
 - The readings in both of the display will update alternately.
 - If math function (dBm, dB) is used in Main Display, when opening Vice Display, math operation will be closed automatically and Vice Display will show the second selected function normally.
 - If math function (Statistics, Limits, Relative) is used in Main Display, when opening Vice Display, the result will still be shown in Main Display and Vice Display will show the second selected function normally.



3. If Temperature function is used in Main Display, set the display mode ( → **【Display】** → **【All】**). Then the result will be shown in Main Display and the current measurement value is shown in Vice Display.

4. Auto Range is adopted by Vice Display. If the same measurement function is used in both the display, so does the range.

5. Measured data in Vice Display cannot be saved into “History”.

Utility Function

The Utility function enables users to set up system parameters, interface parameters of the multimeters.

Press  and  to enter the operating menu of Utility function, as the following diagram shows.

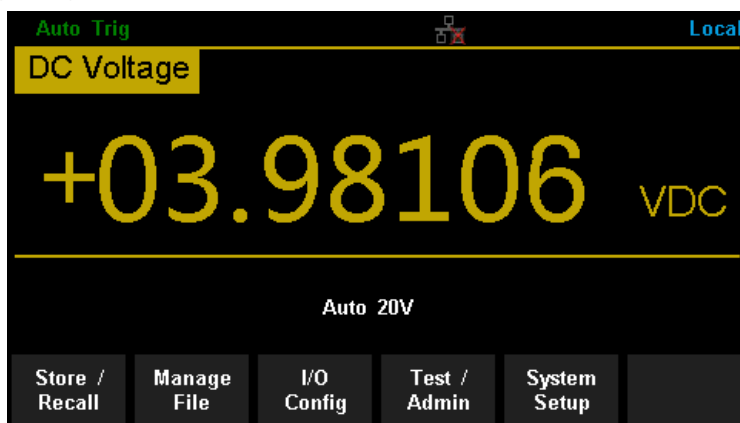

Diagram 2- 24 Utility Function Configuration Interface

Table 2- 1 Utility Function Menu Description

Function Menu	Description
Store/Recall	Store or recall state files.
Manage File	Create a new file, copy, rename or delete a file.
I/O Config	Configure LAN and GPIB interface.
Test/Admin	Provide board test function.
System Setup	Configure instrument's user settings.

Store and Recall

The Store/Recall function enables users to store and recall the instrument state and data files in the local storage as well as in USB storage. After entering into the function menu of Utility, press **【Store/Recall】** to enter the interface as shown in diagram 2-25.

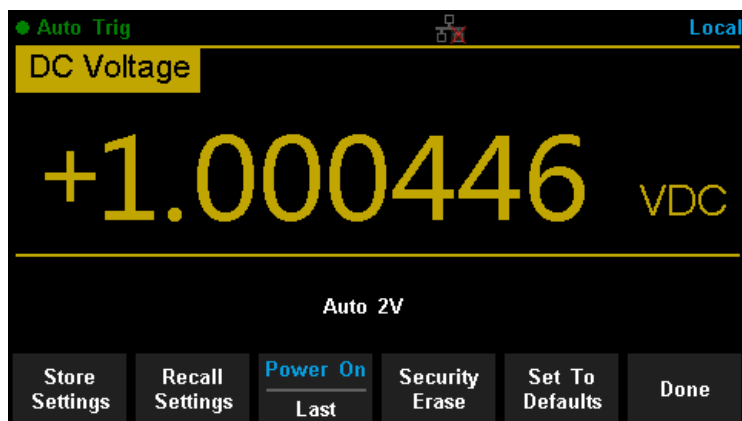

Diagram 2- 25 Store and Recall Interface

Table 2- 2 Store/Recall Function Menu Description

Function Menu	Description
Store Settings	Store state or data files.
Recall Settings	Recall state files.
Power On	Select the state that is loaded at power-up.
Security Erase	Delete all the files stored in local storage and restore the instrument to factory default state.
Set to Defaults	Restore the instrument to factory default state.
Done	Return to the higher level menu.

Store Settings

Store settings allows you to save the system configuration (in the form of **.xml**) or measurement data (in the form of **.csv**) into the internal memory or an external USB storage device. After entering into the function menu of Store/Recall , press **【Store Settings】** to enter the following interface.

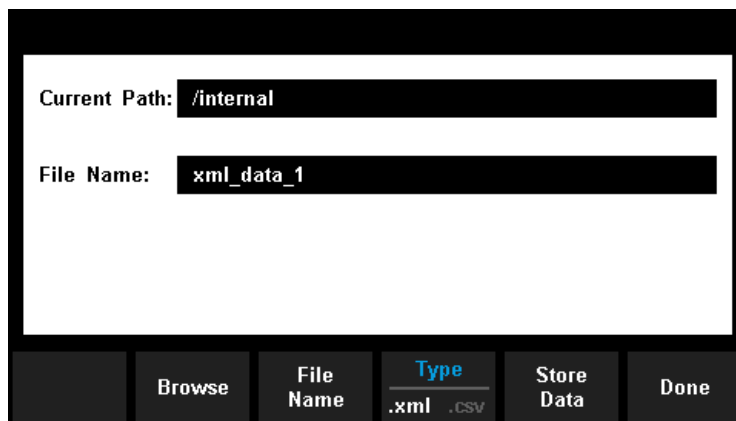

Diagram 2- 26 Store Settings Interface

Table 2- 3 Storage Function Menu Description

Function Menu	Settings	Description
Browse		Choose the location that file will be saved.
File Name		Input the file name.
Type	.xml / .csv	Choose the type of file that will be saved.
Store Data		Store the specified file.
Done		Return to the higher level menu.

Operating Steps:

1. Set the storage directoty

Press **【Browse】** to enter the following interface, then use direction keys or menu operation keys to choose the storage directory. Press **【Select】** to set the current directory as storage location and Return to higher level menu.

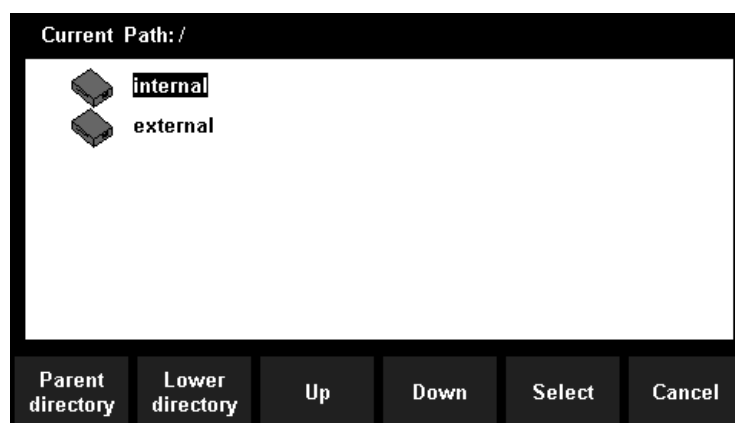

Diagram 2- 27 storage directory Settings Interface

2. Set the file name

Press **【File Name】** to enter the following interface and input the name of the stored file.

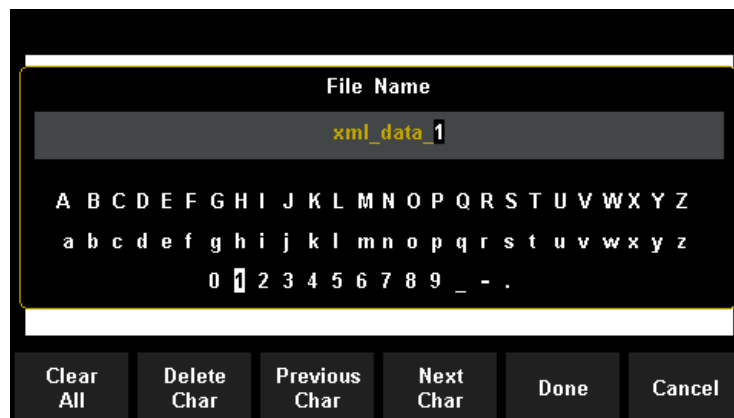

Diagram 2- 28 Input File name

The method of inputting file name:

- Press direction keys to select a desired char in the input area.
 - Press “OK” key on the front panel to input selected char in the input area.
 - Press **【Clear All】** to clear all input chars.
 - Press **【Delete Char】** to delete the letter on which the cursor taking place.
 - Press **【Previous Char】** to move the cursor in the file name area to the previous char.
 - Press **【Next Char】** to move the cursor in the file name area to the next char.
 - Press **【Done】** to save the current file and return to the higher level menu.
 - Press **【Cancel】** to cancel the current operation and return to the higher level menu.
- .
3. Set the type of stored file
Press **【Type】** to set the type of stored file.
 - .xml: save the current system configuration as an “.xml” file.
 - .csv: save the current measurement result as a “.csv” file.
 4. Save the file
Press **【Store Data】** to store the specified file
 5. Exit
Press **【Done】** to return to the higher level menu.

Recall Settings

Recall settings allows you to read the system configuration from the internal memory or an external USB storage device. After entering into the function

menu of Store/Recall , press **【Recall Settings】** to enter the following interface.

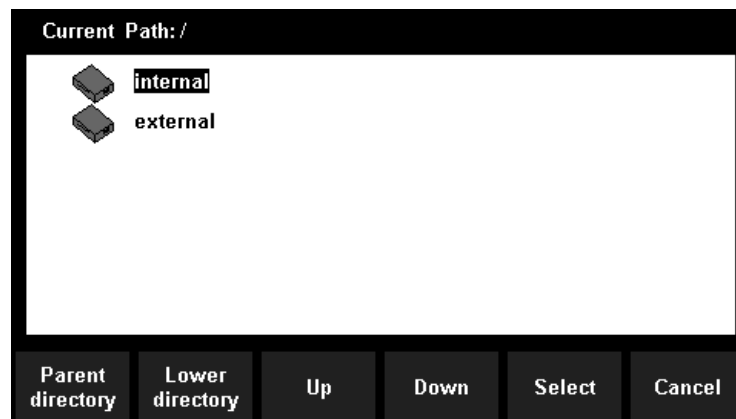

Diagram 2- 29 Recall Settings Interface

Use direction keys or menu operation keys to choose the state file with the suffix “.xml”. Press **【Select】** to read the file and restore the instrument to specified state. Press **【Cancel】** to return to higher level menu.

Power On

Select a system configuration to be used at power-on from “Default” and “Last” (configuration at last power-off). The setting will be available at the next power-on.

Security Erase

Press **【Security Erase】**, the instrument will display prompt message ‘Are you sure to delete all stored files?’ Then press **【Yes】**, the instrument will delete all the files stored in local storage and restore the instrument to factory default state.

Set to Defaults

Press **【Set to Defaults】** the instrument will be restored to factory default state

Manage File

The **Manage Files** function allows you to create, copy, delete, and rename files and folders in the instrument's internal flash memory or on a USB drive attached to the front panel. It also allows you to capture the current screen to a bitmap (*.bmp) file. After entering into the function menu of Utility, press **【Manage File】** to enter the interface as shown in diagram 2-30.

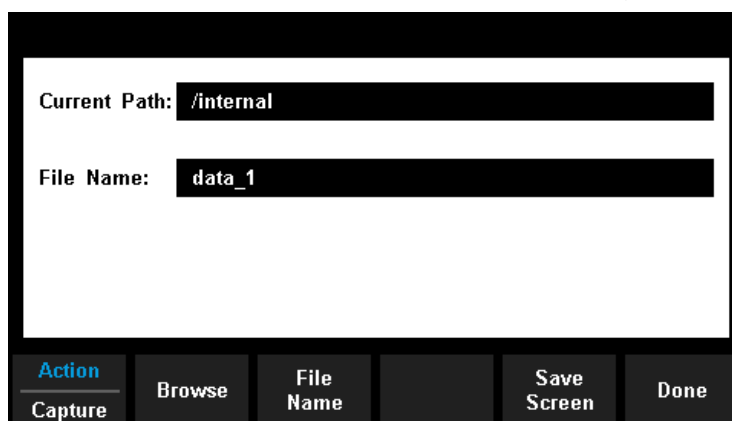

Diagram 2- 30 Manage File Interface

Press **【Action】** and select **【Folder】**, **【Capture Display】**, **【Copy】**, **【Rename】** or **【Delete】** to do the corresponding operation.

- **Folder** - To create a folder, **Browse** to the internal or external location for the folder, press **File Name**, enter a folder name and press **Done**. Press **Create Folder > Done**.
- **Capture Display**- To saves a screen capture, **Browse** to the internal or external location for the screen capture, press **File Name**, enter a name and press **Done**. Press **Save Screen > Done**.
- **Copy** - To copy a file or folder, press **Copy**. **Browse** to the folder or file to be copied and press **Select**. Press **Copy Path** and select an internal or external path for copying. Press **Perform Copy > Done**.
- **Rename** - To rename a file or folder, press **Rename**. **Browse** to the folder or file to be renamed and press **Select**. Press **New Name**, enter a new name and press **Done**. Press **Perform Rename > Done**.
- **Delete** - To delete a file or folder, press **Delete** and **Browse** to the folder or file to delete. Press **Select >Perform Delete > Done**.

I/O Configuration

Press **【I/O Config】** to enter the following interface and set up the parameters.

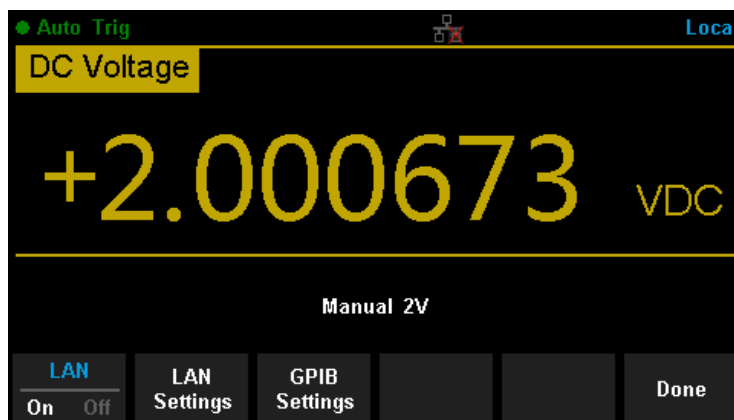

Diagram 2- 31 I/O Configuration Interface

LAN Settings

The Multimeter enables users to operate instrument remotely by LAN interface and store or recall internet settings. You can look over current LAN settings and set up IP address and subnet mask.

After entering into the function menu of Utility, press **【I/O Config】**. Select **【On】** → **【LAN Settings】** → **【Modify Settings】** to enter the following interface.

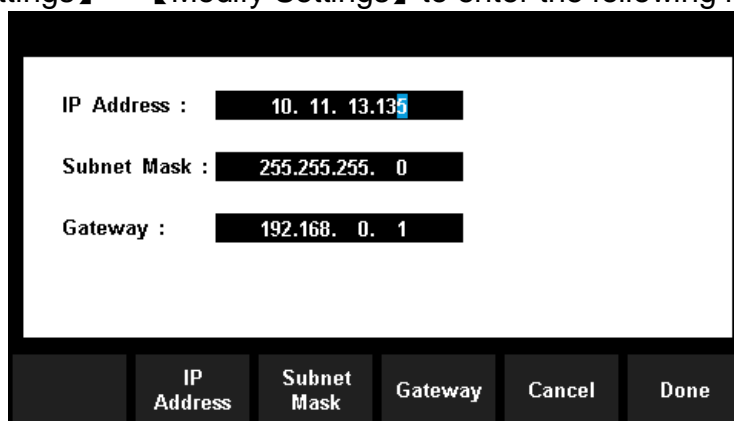

Diagram 2- 32 LAN Settings Interface

Table 2- 4 LAN Settings

Function Menu	Description
IP Address	Set up IP address.
Subnet	Set up subnet mask.

Mask	
Gateway	Set up gateway
Cancel	Cancel current operation and return to the higher level menu.
Done	Save all changes and return to the higher level menu.

GPIB Settings

Each device on the GPIB (IEEE–488) interface must have a unique address. The default address is 30 when the instrument is leaving the factory. The address of Multimeter can be any integral value between 1 and 30.

Operating Steps:

1. After entering into the function menu of I/O configuration, press **【GPIB Settings】** to enter the interface shown in diagram 2-33.





Diagram 2- 33 GPIB Settings

2. Users can change the value of GPIB address by direction keys.
3. Press **【Select】** to set the input value as GPIB address and return to the higher level menu.

Board Test

SDM3065X provides self-test functions, including Key Test, LCD Test, Beeper Test and Chip Test.

Operating Steps:

1. Press  and , then choose **【Test/Admin】** → **【Board Test】** to enter the following interface.

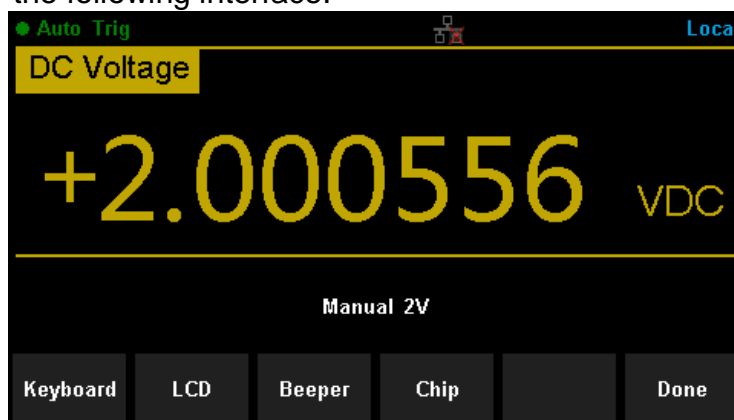

Diagram 2- 34 Board Test Interface

Table 2- 5 Board Test Function Description

Function Menu	Description
Key	Test the instrument's keys.
LCD	Test the instrument's LCD screen.
Beeper	Test the instrument's beeper.
Chip	Test the instrument's chips.
Done	Return the higher level menu.

2. Test the keys.

Select **【Key】** to enter the key test interface, as the Diagram 2-47 shows. The on-screen lathy rectangle shapes represent the keys on the front panel. Test all keys and knobs and you should also verify that all the backlit buttons illuminate correctly.

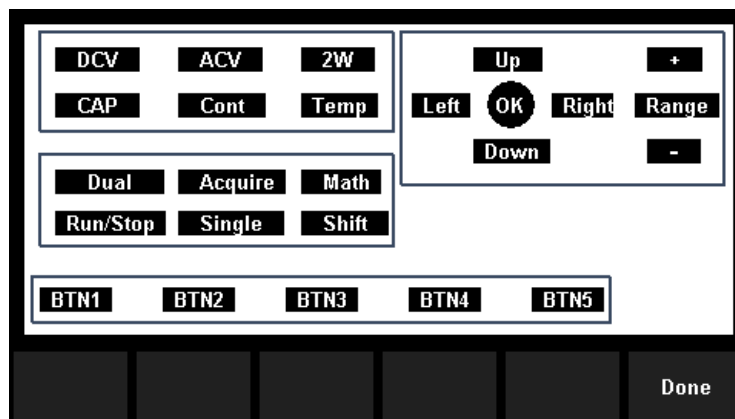

Diagram 2- 35 Key Test Interface

NOTE:

- Before you operate, the shapes on the screen display blue color.
- The corresponding area of tested buttons or knobs would display green color.
- Press **【Done】** to exit the test.

3. Test the LCD screen.

Select **【LCD】** to enter the screen test interface, the screen shows the message:” Press ‘Change’ to change Press ‘Done’ to exit“. Press **【Change】** to start the test and observe if the screen has severe color or other display error. As the Diagram 2-36 shows.



Diagram 2- 36 LCD Test Interface

NOTE:

- Press **【Change】** to change the color of the screen. There are three colors: red, blue and green.
- Press **【Done】** to exit the test.

4. Test the beeper.

Press **【Beeper】** to test the beeper. Under regular circumstance, press

【Beeper】 one time and the instrument will beep one time.

5. Test the chips.

Press 【Chip】 → 【Start】 to enter chip test interface, as Diagram 2-37 shows.

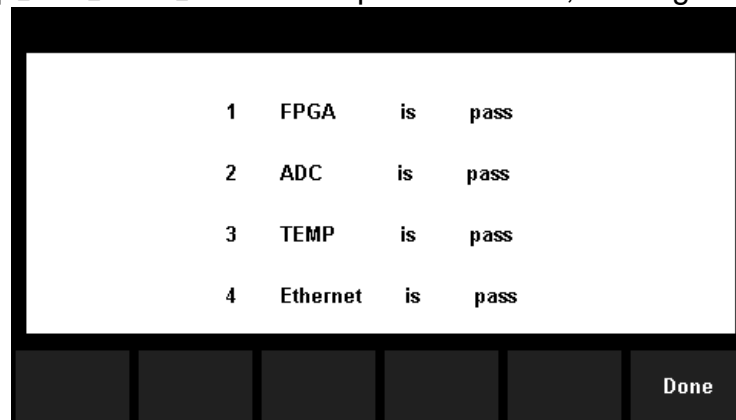

Diagram 2- 37 Chip Test Interface

NOTE:





- If the test is passed, the corresponding result shows “pass”.
- If the test is failed, the corresponding result shows “fail”.

6. Press 【Done】 to exit the board test.

Firmware Update

The software of the Multimeter can be updated directly via USB flash drive, updating current software version to desired software version.

Operating Steps:

1. Copy the update file to the USB flash drive.
2. Insert USB flash drive to USB host interface on the front panel of the Multimeter.
3. Press  →  → **【System Setup】** → **【Firmware Update】**, then press **【Browse】** and select the update file. Next, press **【Update】** → **【Yes】** to start updating the system software.
4. After accomplishing update, the screen shows message: "Firmware Update Done!" Then you can move the USB flash drive away.
5. Restart the Multimeter and check the version information.
Press  →  → **【System Setup】** → **【System Info】** to check if the software and hardware version after updating is in accordance with the desired version. If not, the updating is failed and you need update once more as the above steps.
6. After checking, press **【Done】** to exit the system information interface.

NOTE:

Don't cut off the power during the instrument is updating

System Setup

Press **Shift** and **Dual** , then select **【System Setup】** to enter the following interface.

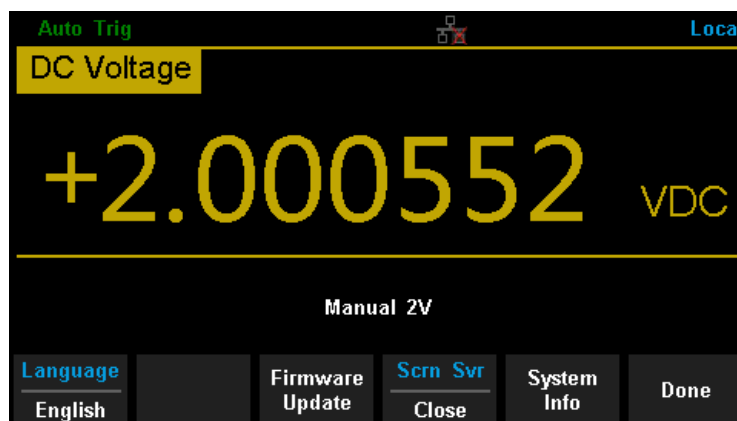

Diagram 2- 38 System Setup Interface

Table 2- 6 System Settings Menu Description

Function Menu	Description
Language	Select the display interface language.
Firmware Update	Update software version,
Screen	Set up the screen protection function.
System Info	View system information.
Done	Return to the higher level menu.

1. Select language.

The Multimeter supports two kinds of languages, English and Chinese. Press **【Language】** to select the Language of the menu..

2. Set up the time of screen protection.

Press **【Screen】** to set screen protection as 1 Min, 5 Mins, 15 Mins, 30 Mins, 1 Hour, 2 Hours or 5 Hours according to different demands. Activate the screen saver program and screen saver will be on if no action is taken within the time that you have selected. Press any button the resume.

3. View system information.

Press **【System Info】** to view system information, including startup times, software version, hardware version, production ID and serial number, as shown in the following diagram.

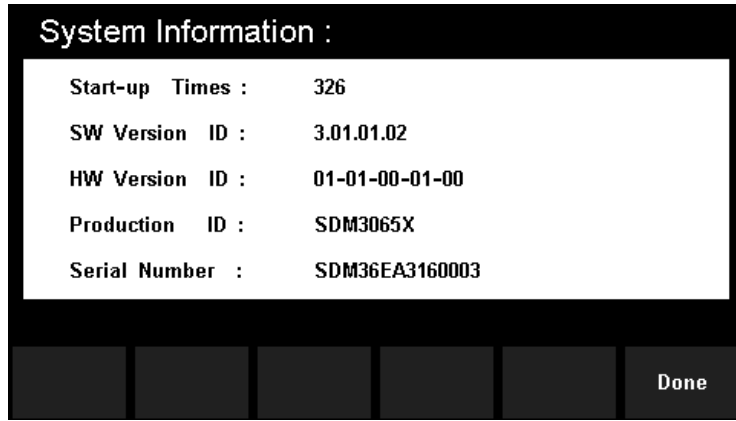



Diagram 2- 39 System Information

Acquire

Sampling is a process of acquiring and digitizing signal. The optional Trigger methods of the Multimeter include Auto Trigger, Single Trigger and External Trigger.

Press  to enter the interface shown as the following diagram:

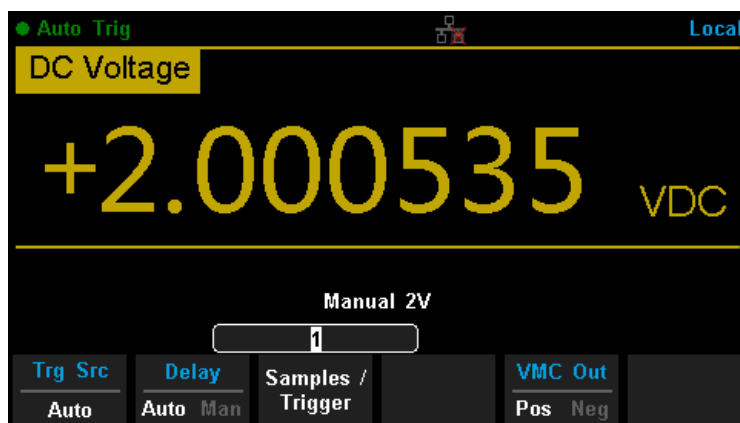

Diagram 2- 40 Acquire Interface



Table 2- 7 Function Menu of triggering parameter

Function Menu	Description
Trg Src	Set the source of trigger.
Slope	Set the slope polarity of external trigger.
Delay	Set the delay.
Samples/Trigger	Set the number of samples or trigger.
VMC Out	Set the polarity of output pulse signal when sampling signal is finished.

Auto Trigger

Auto Trigger parameters that need to be set up include delay, samples/trigger and VMC out.

Operating Steps:

1. Press  , then select **【Trg Src】**→**【Auto】**or press  on the front panel directly to enable Auto Trigger.

2. Set the delay.

Delay is the waiting time after the trigger signal is sent out and before the acquiring starts. Press **【Delay】** to select Auto or Manual mode. When choosing Manual mode, Left and Right keys are used to switch the number of a numerical value, Up and Down keys are used to change the selected value.

3. Set the number of samples or trigger.

Press **【Samples/Trigger】**to set the sample count. Left and Right keys are used to switch the number of a numerical value, Up and Down keys are used to change the selected value.

Sample Count

- Sample Count indicates the count of point sampled while the Multimeter getting a signal of Single Trigger.
- The range of sampling point should be between 1 and 599999999.
- The default value of Sample Count is 1.



4. Set the VMC Out.

The Multimeter output a pulse signal through the VM COMP interface on the rear panel after sampling signal is finished Press **【VMC Out】**to choose Positive or Negative polarity.

Single Trigger

Single Trigger parameters that need to be set up include delay, samples /trigger and VMC out.

Operating Steps:

1. Press  , then select **【Trg Src】** → **【Single】** or press  on the front panel directly to enable Single Trigger.
2. Set the delay.
Press **【Delay】** to select Auto or Manual mode.
3. Set the number of samples or trigger.
Press **【Samples/Trigger】** to set sample count.
4. Set the VMC Out.
The Multimeter output a pulse signal through the VM COMP interface on the rear panel after sampling signal is finished.
Press **【VMC Out】** to choose Positive or Negative polarity.

External Trigger



The external trigger signal will be input via EXT TRIG interface on the rear panel. External trigger parameters that need to be set up include delay, samples /trigger, slope and VMC out.

Operating Steps:

1. Press  , then select **【Trg Src】** → **【Ext】** enable External Trigger.
2. Set the polarity of slope.
Press **【Slope】** to choose Positive or Negative polarity.
3. Set the delay.
Press **【Delay】** to choose Auto or Manual mode.
4. Set the number of samples or trigger.
Press **【Samples/Trigger】** to set sample count.
5. Set the VMC Out.
In External Trigger mode, the Multimeter could output a pulse signal through the VM COMP interface on the rear panel after sampling signal is finished.

Help System

SDM3065X provides powerful built-in help system. You can recall help information at any time during using the instrument. You also can get a particularly help for every button on the front panel or menu softkey by using the built-in help system. Or you can get help about familiar operations with the help list.

Press  and  to enter the help list, as the following diagram shows.

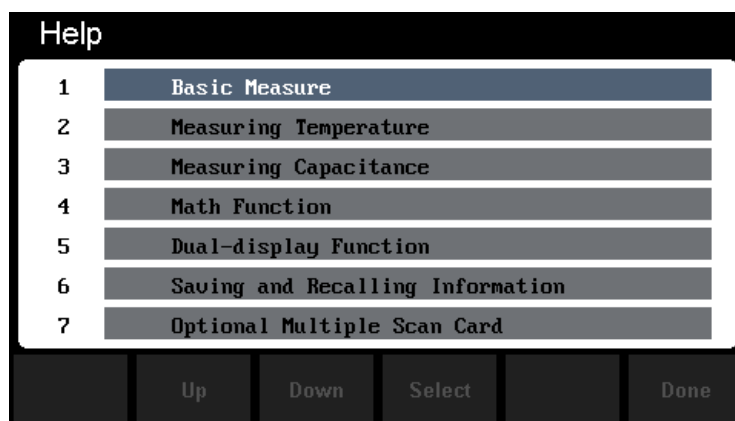

Diagram 2- 41 Help Menu

Table 2- 8 Help System Operating Menu

Function Menu	Description
Up	Move up the cursor and select the help menu.
Down	Move down the cursor and select the help menu.
Select	Select the help information you want and read it.
Done	Return to the higher menu.

1. Basic Measure.

Get basic measurement types and methods to connect the leads in different measurements.

2. Measuring Temperature.

Get the method to measure temperature.

3. Measuring Capacitance.

Get the method to measure temperature.

4. Math Function.

Introduce how to use the math function while you are measuring.

5. Dual-display Function.

Get the method to use the dual-display function while you are measuring.

6. Saving and Recalling Information.

Introduce how to store and recall the data/parameter/ sensors files.

7. Optional Multiple Scan Card.

Get help about operating optional multiple scan cards.

8. The convention and Tips of Softkeys.

Get help about the convention and tips of softkeys.

9. Technical Support.

Get the method to obtain technical support.

Explanation:

- In the help menu interface, you also can move cursor and select the corresponding menu by up and down direction keys and press "OK" to read the help information.
- While reading help information, you also can look up and down the information by up and down direction keys.

Math Function

The Multimeter provides five math functions: Statistics, Limits, dBm, dB and Relative. Choose different math functions to meet different measurement demands. Math functions can only be used in DC Voltage, AC Voltage, DC Current, AC Current, Resistance, Frequency, Period and Temperature measurement. Among these functions, dBm and dB are only used in DC Voltage and AC Voltage measurement.

Press  to show the operating menu of math functions on the screen, as shown in the following diagram.

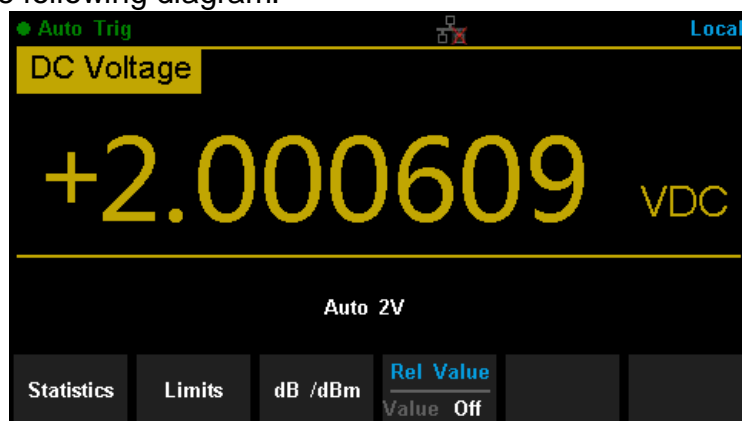

Diagram 2- 42 Math Function Menu

Table 2- 9 Math Function Menu Description

Function Menu	Settings	Description
Statistics		Reading statistic functions, including: max, min, average, span, std dev and samples.
Limits		The Limits function performs Pass/Fail testing according to the specified upper and lower limits.
dBm		The dBm is based on a calculation of power delivered to a reference resistance, 0dBm = 1mW.
dB		The dB measurement is the difference between the input signal and a stored relative value.
Rel Value	Value/Off	Turn on the relative value function and set up the value. Or turn off the function.

Explanations:

- Math function can only be applicable to the main display.
- If measurement function is changed, all math functions will be closed except Statistics.

Statistics

There are many kinds of reading statistic functions, including: Max, Min, Average, Standard deviation and so on.

Press  → **【Statistics】** → **【Show】** to enter the interface shown in the following diagram.

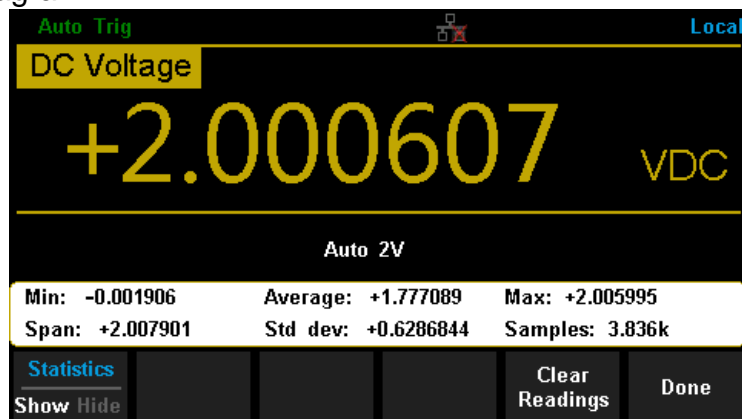

Diagram 2- 43 Statistics

Table 2- 10 Statistic Measurement Menu Function Description

Function Menu	Settings	Description
Min		Show the minimum statistics value of current measurement.
Average		Show the average statistics value of current measurement.
Max		Show the maximum statistics value of current measurement.
Span		Show the span of current measurement.
Std dev		Show the std dev statistics value of current measurement.
Samples		Show the maximum statistics value of current measurement.
Statistics	Show/Hide	Show or hide the statistics function interface.
Clear Readings		Clear all current readings and restart statistics.
Done		Return to the higher level menu.

Statistics Function:

- In statistic function, the first reading is usually set to the maximum or minimum value. When getting more readings, current displaying value is always the maximum/minimum reading among all the measured values.
- The maximum, minimum, average and reading quantities are stored in volatile memory.

Limits

Limits function is available to prompt signals beyond ranges according to the upper and lower parameters. Following are some measurement functions which are able to do limit operation: DC Voltage, AC Voltage, DC Current, AC Current, Resistance, Frequency, Period, Capacitance and Temperature.

Press  → **【Limits】** → **【On】** to enter the interface shown in the following diagram.

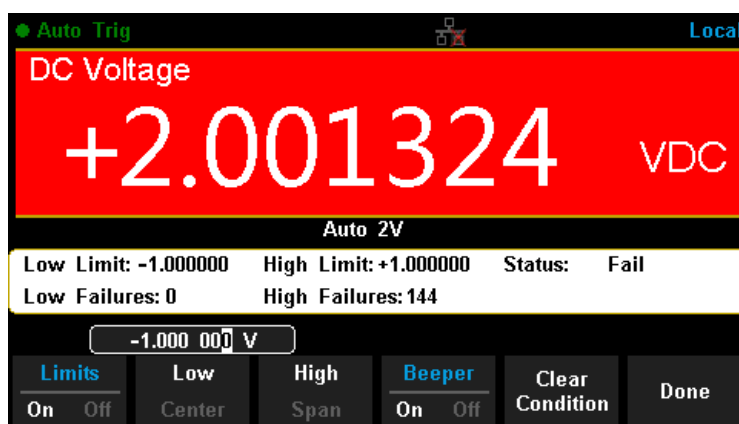

Diagram 2- 44 Limits

Table 2- 11 Limits Measurement Menu Function Description

Function Menu	Settings	Description
Limits	On/Off	Turn on or turn off the Limits function.
Low		Set the desired lower limit.
Center		Set the desired center value
High		Set the desired upper limit.
Status		Show the status of limit test.
Low Failures		Show the times that reading is lower than the limit.
High Failures		Show the times that reading is higher than the limit.
Span		Set the desired span.
Beeper	On/Off	When the beeper is on, if the reading is lower or higher than limits, the instrument will beep once.
Clear Condition		Clear all current readings and restart to test.
Done		Save all changes and return to the higher level menu.

1. How to Set Limits

Select **【High】**, **【Low】**, **【Center】** or **【Span】** and then switch to the needed digit by Left or Right Direction keys and input numerical value by Up and Down Direction keys.

2. Unit

The unit of Limits is decided by the current measurement function.

3. Over hint

- When the reading is lower than the set lower limit, the color of main display will switch blue to red.
- When the reading is higher than the set higher limit, the color of main display will switch blue to red.
- When the reading is lower or higher than the set limits, the Beeper will beep once. (The beeper is turned on.)

The range of Limits function:

- The Limits range is -120% ~ +120% of the current measurement range.
- The upper limit value should be always bigger than the lower limit value.
- The upper and lower values are stored in volatile memory. They will be set to default values when the power is on.

dBm

The dBm function is logarithmic and based on a calculation of power delivered to a reference resistance, relative to 1 mill watt. Besides, this function only applies to AC voltage and DC voltage measurements.

Press  → **【dB/dBm】** → **【On】** and select **【Function dBm】** to enter the interface shown in the following diagram.



Diagram 2- 45 dBm Function Interface

Table 2- 12 dB Measurement Function Menu Function Description

Function Menu	Settings	Description
dB/dBm	On/Off	Turn on or turn off dB or dBm function.
Function dBm		Open dBm function and the lower right corner of the main display show “dBm”.
Ref R		Set the parameter via direction keys: 50Ω ~ 8000Ω.
Done		Save all changes and return to the higher level menu.

The computation method of the dBm:

When dBm function is turned on, the measured value of voltage is transformed into dBm according to the following formula.

$$\text{dBm} = 10 \times \text{Log}_{10} [(\text{Reading}^2 / R_{\text{REF}}) / 0.001\text{W}]$$

dB

Each dB measurement is different between the input signal and a stored relative value, with both values converted to dBm. The dB function applies to AC voltage and DC voltage measurements only.

Press  → **【dB/dBm On】** and select **【Function dB】** to enter the interface shown in the following diagram.

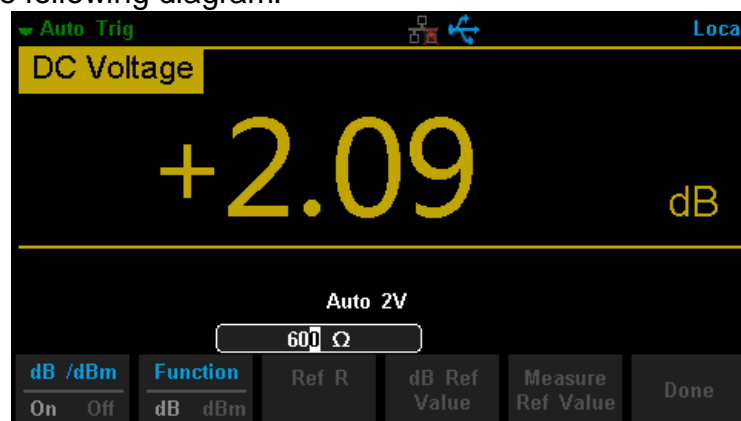

Diagram 2- 45 dB Function Interface

Table 2- 13 dB Measurement Function Menu Function Description

Function Menu	Settings	Description
dB/dBm	On/Off	Turn on or turn off dB or dBm function.
Function dB		Open dB function and the lower right corner of the main display show “dB”.
Ref R		Set the parameter via direction keys: 50Ω ~ 8000Ω.
dB Ref Value		Set the referred value of dB.
Measure Ref Value		Set the referred value of measurement.
Done		Save all changes and return to the higher level menu.

The computation method of the dB:

$$dB = 10 \times \text{Log}_{10} [(Reading^2 / R_{REF}) / 0.001W] - (dB \text{ setting value})$$

R_{REF} expressed measuring the resistance value in the actual electric circuit.
Range of the dB setting value: -200 dBm ~ +200 dBm. The default is 0 dBm.

dB value:

- Input a value in dB setting interface by direction button, and then store it as dB setting value.
- Settings of dB value are stored in volatile memory.

Relative Value

Relative value is used for relative measurement. Actual measurement reading is the depression between measurement value and preset value.

The Multimeter allows operating for the following parameters: DC Voltage, AC Voltage, DC Current, AC Current, Resistance, Frequency, Period, Capacitance and Temperature.

Press  → **【Rel Value】** to enter the interface shown in the following diagram.

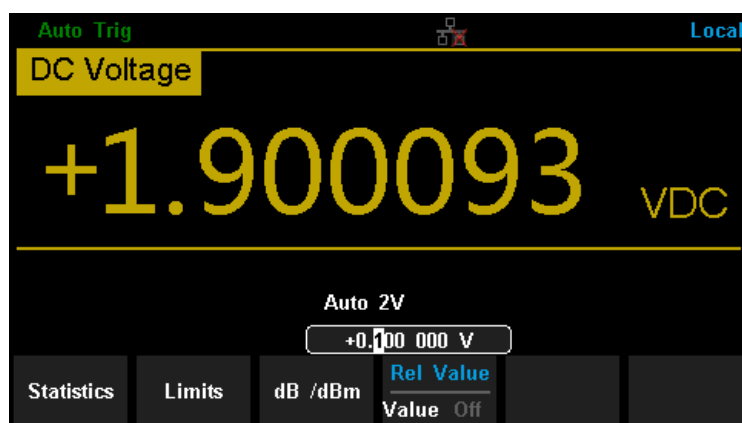

Diagram 2- 46 Relative Operation

Table 2- 14 Rel Value Operation Function Menu

Function Menu	Description
Value	Select current measurement value as preset value.
Off	Turn off the relative operation function.



When Rel Value function is turned on, the result of relative measurement will show on the screen.

Main display = Measurement value – Preset value

Display Mode

The Multimeter supports four types of way to view measured data: “Number”, “Bar Meter”, “Trend Chart” and “Histogram”.

Number

Press  and  to open the menu of display mode and press **【Display】** to enter the following interface. “Number” is always the selected mode when the Multimeter is turned on.

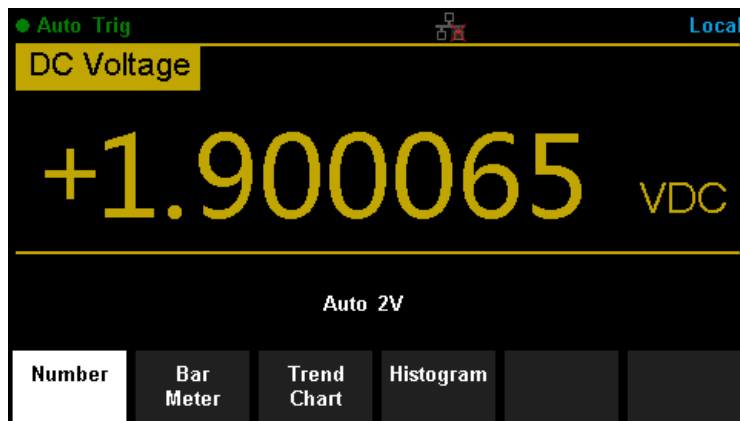

Diagram 2- 47 Number Display Mode

Bar Meter

Operating Steps:

1. Press **【Bar Meter】** to enter Bar Meter display mode.

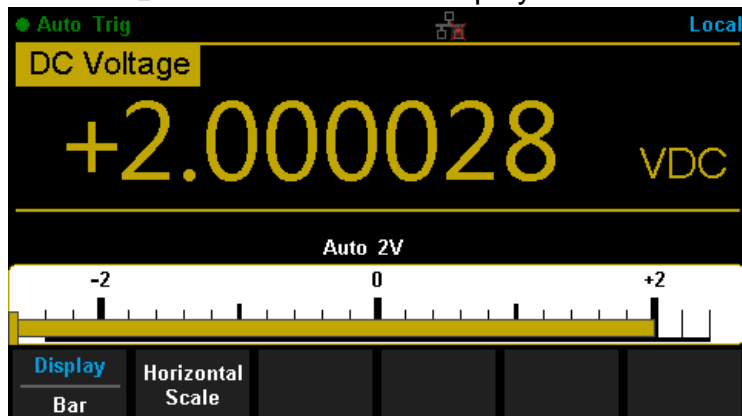

Diagram 2- 48 Bar Meter Display Mode

2. Press **【Horizontal Scale】** to choose the way to set the vertical scale as Default or Manual mode.

Table 2- 15 To Set the Vertical Scale of Bar Meter manually

Function Menu	Description
Low	Set the low value of horizontal scale.
High	Set the high value of horizontal scale.
Center	Set the center value of horizontal scale.
Span	Set the span of horizontal scale.
Done	Save all changes and return to the higher level menu.

Trend Chart

Operating Steps:

1. Press **【Trend Chart】** to enter Trend Chart display mode.

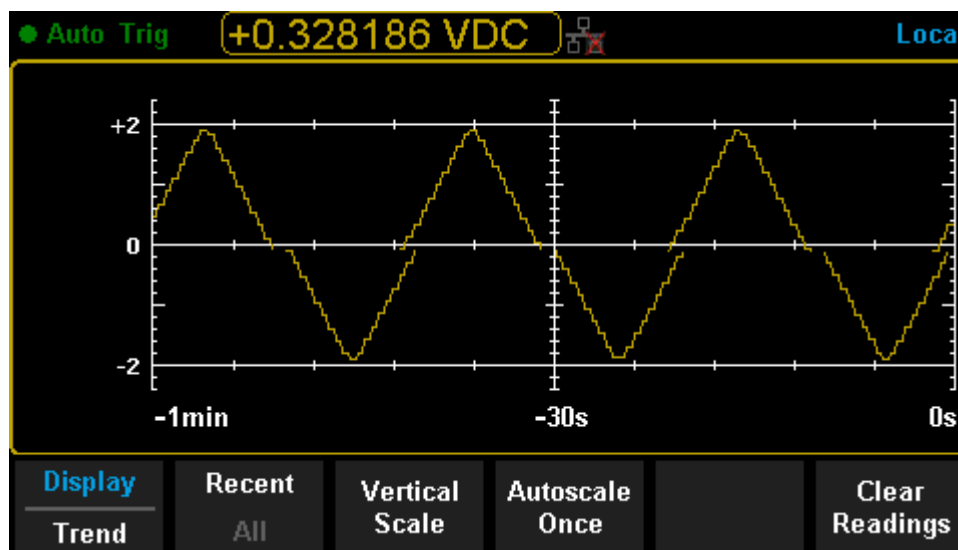

Diagram 2- 49 Trend Chart Display Mode

Table 2- 16 Trend Chart Display Mode

Function Menu	Description
Display Trend	Currently selected display mode is Trend Chart.
Recent All	Show recent or all readings.
Horizontal Scale	Choose the mode of Horizontal Scale.
Autoscale Once	Automatically set the horizontal scale once.
Clear Readings	Clear all current readings and restart statistics.

2. Press **【Horizontal Scale】** to choose the way to set the horizontal scale as Default , Auto or Manual mode.
Press **【Auto】** and the Multimeter will set the vertical scale automatically.

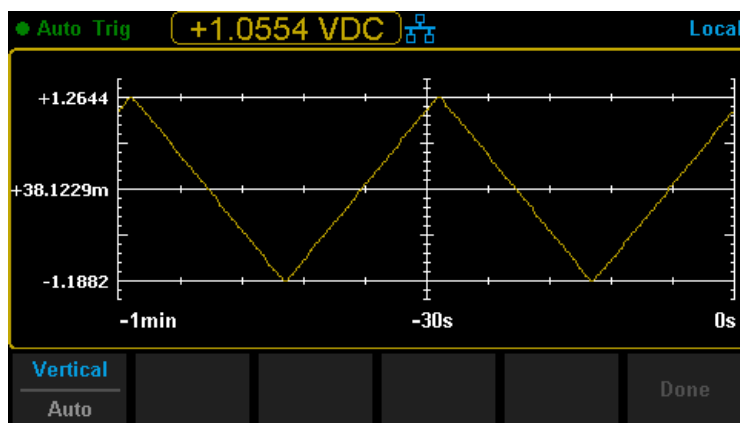

Diagram 2- 50 Auto Vertical Scale

Press **【Manual】** and you can set the vertical scale manually, as the following diagram shows.

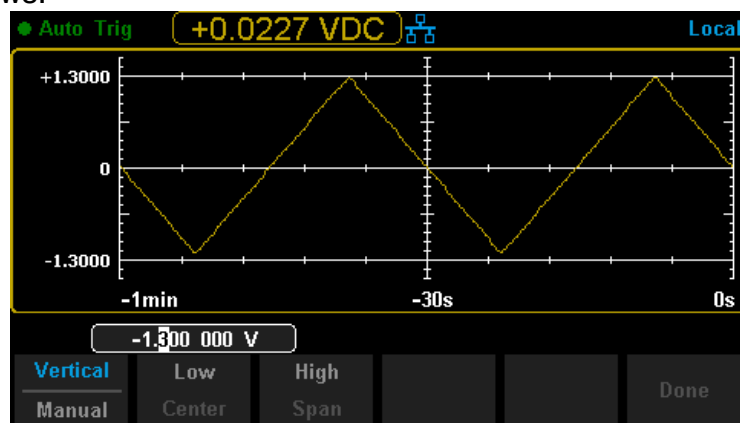

Diagram 2- 51 Manual Vertical Scale

Histogram

Operating Steps:

1. Press **【Histogram】** to enter Histogram display mode.

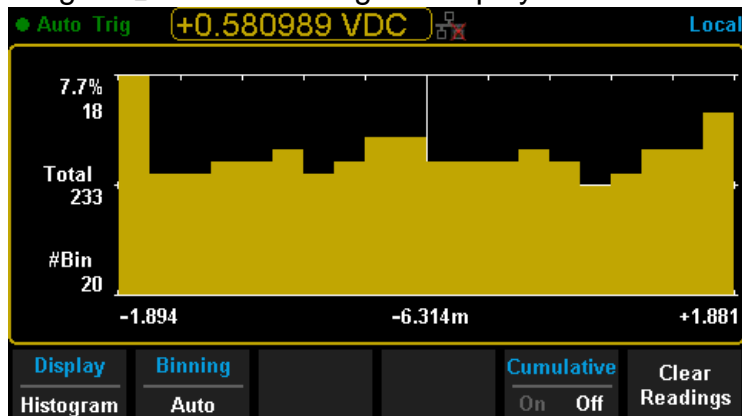

Diagram 2- 52 Histogram Display Mode

Table 2- 17 Histogram Display Mode

Function Menu	Settings	Description
Display Histogram		Currently selected display mode is Histogram.
Binning		Set Binning as Auto or Manual mode.
Bin Set		Set the parameters of Bin.
Cumulative	On/Off	Turn on or off Cumulative function.
Clear Readings		Clear all current readings and restart statistics.

2. Press **【Binning】** to choose the way to set Binning as Auto or Manual mode. When in Manual mode, press **【Bin Settings】** to enter the following interface.

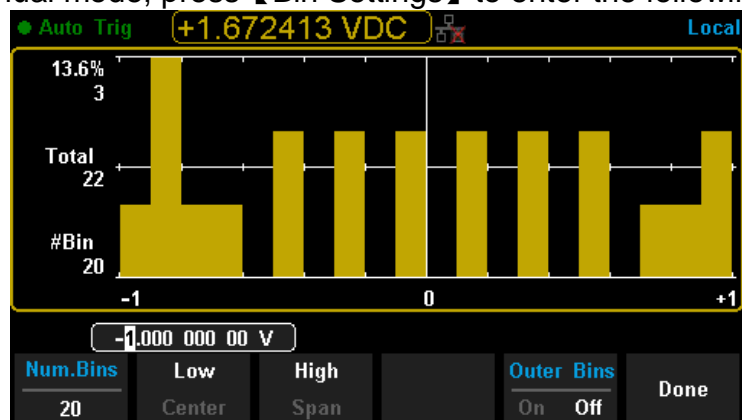



Diagram 2- 53 Bin Set Interface

Table 2- 18 Bin Set

Function Menu	Settings	Description
Num.Bins		Set the number of Bins, 10, 20, 40, 100, 200 or 400 selected.
Low		Set the low value of horizontal scale.
High		Set the high value of horizontal scale.
Center		Set the center value of horizontal scale.
Span		Set the span of horizontal scale.
Outer Bins	On/Off	Show the bins beyond the scope or not.
Done		Save all changes and return to the higher level menu.

Trigger

The Multimeter supports Trigger function. Press  or  on the front panel to trigger the Multimeter by Auto or Single mode. Auto trigger is considered as a default when the power is on.

Auto Trigger

Press  on the front panel one time and Auto Trigger will be started to capture continuous readings automatically. By the time, the black field of the screen will show “● **Auto Trigger**”. Press  again and the trigger is stopped.

Single Trigger

Press  on the front panel, Single Trigger will be started one time and generate an effective reading. By the time, the black field of the screen will show “● **Single Trig**”.

Explanation:

In Remote Mode, the black field just above the screen will show “● **Imme Trig**”.

Press  to switch back to the local mode and the Multimeter will choose Auto Trigger automatically.

Hold Measurement Function

Hold Measurement function provides users with a stable reading on the screen of the front panel. When the test leads are put away, the reading is still held on the screen, which makes users can view measured history data.



Press  and  to open Hold measurement function interface, the black field just above the screen will show “ • Probe Hold”, as shown in the following diagram.



Diagram 2- 54 Hold Measurement Function Interface

Table 2- 19 Hold Measurement Function

Function Menu	Settings	Description
Probe Hold	On/Off	Turn on or off Probe Hold function.
Beeper	On/Off	Turn on or off the Beeper.
Clear List		Clear all current readings and restart to statistics.

Chapter 3 Measurement Tutorial

True RMS AC Measurement

The AC measurement of the Multimeter has true RMS response. The power dissipated in a resistor within a time is proportional to the square of the measured true RMS voltage, independent of wave shape. The instrument can accurately measure true RMS voltage or current, as long as the wave shape contains negligible energy above the effective bandwidth.

The AC voltage and AC current functions measure the “AC coupled” true RMS value, which is to measure the RMS value of the AC component (DC component is rejected) of the input signal. For sine waves, triangle waves, and square waves, the AC and AC+DC values are equal since these waveforms do not contain a DC offset. See the following table 5-1.

Table 3- 1 True RMS AC Measurement of Sine, Triangle and Square waves

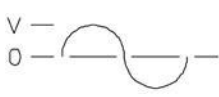
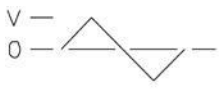
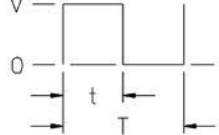
Waveform	Crest Factor (C.F.)	AC RMS	AC+DC RMS
	$\sqrt{2}$	$\frac{V}{\sqrt{2}}$	$\frac{V}{\sqrt{2}}$
	$\sqrt{3}$	$\frac{V}{\sqrt{3}}$	$\frac{V}{\sqrt{3}}$
	$\sqrt{\frac{T}{t}}$	$\frac{V}{\text{C.F.}} \times \sqrt{1 - \left(\frac{1}{\text{C.F.}}\right)^2}$	$\frac{V}{\text{C.F.}}$

Non-symmetrical waveforms, such as pulse trains, contain DC voltages which are rejected by AC coupled true RMS measurements.

An AC coupled true RMS measurement is desirable in situations where you are measuring small AC signals in the presence of DC offsets. For instance, measuring AC ripple present on DC power supplies. There are situations, however, where you might want to know the AC+DC true RMS value. You can determine this value by combining results from DC and AC measurements as the following shows. You should perform the DC measurement using 6.5 digit mode for best AC rejection.

$$RMS_{(AC+DC)} = \sqrt{AC^2 + DC^2}$$

Crest Factor Errors (non-sinusoidal inputs)

A common misconception is that "since an ac Multimeter is true RMS, its sine wave accuracy specifications apply to all waveforms." Actually, the shape of the input signal can dramatically affect measurement accuracy. A common way to describe signal wave shapes is "crest factor". Crest factor is the ratio of the peak value to RMS value of a waveform.

Generally speaking, the greater the crest factor, the greater the energy contained in high frequency harmonics. All Multimeters have errors that are crest factor dependent. (The crest factor errors do not apply for input signals below 100Hz.)

You can estimate the measurement error due to signal crest factor as shown below:

Total Error=Error (Sine wave) + Error (Crest factor) + Error (Bandwidth)

Error (Sine wave): error for sine wave

Error (Crest factor): crest factor additional error.

Error (Bandwidth): estimated bandwidth error as shown below:

$$\text{Bandwidth error} = \frac{-C.F. \times F}{4 \pi \times BW} \times 100\% \text{ (\% reading)}$$

C.F.: signal crest factor

F: fundamental frequency of pulse

BW: effective bandwidth of the Multimeter

Example:

Calculate the approximate measurement error for a pulse train input with a crest factor of 2 and a fundamental frequency of 20 kHz. For this example, assume 1-year accuracy specifications of the Multimeter: $\pm (0.05\% \times \text{reading} + 0.03\% \times \text{range})$.

$$\begin{aligned} \text{Total Error} &= (0.05\% \times \text{reading} + 0.03\% \times \text{range}) + (0.05\% \times \text{range}) + \\ &\quad (0.8\% \times \text{reading}) \\ &= 0.85\% \times \text{reading} + 0.08\% \times \text{range} \end{aligned}$$

Loading Errors (AC Voltage)

In the AC Voltage function, the input of SDM3065X appears as a 1MΩ resistance in parallel with 100pF of capacitance. The test lead that you use to connect signals to the Multimeter will also add additional capacitance and loading. The approximate input resistances of the Multimeter at different frequencies are listed in the following table.

Table 5- 2 Approximate Input Resistances at Different Frequencies

Input Frequency	Input Resistance
100Hz	1MΩ
1kHz	850kΩ
10kHz	160kΩ
100kHz	16kΩ

For low frequencies:

$$\text{Error (\%)} = \frac{-R_s}{R_s + 1M\Omega} \times 100\%$$

For high frequencies:

$$\text{Error (\%)} = \left[\frac{1}{\sqrt{1 + (2\pi \times F \times R_s \times C_m)^2}} - 1 \right] \times 100\%$$

F: input frequency

R_s: source resistance

C_m: input capacitance (100pF) plus test lead capacitance

Chapter 4 General Troubleshooting

The following is a list of the troubles that you may meet while using the Multimeter and their solutions. Please handle as the corresponding steps when meeting these troubles. If you still can't handle them, please contact SIGLENT in time.

1. If the screen of the Multimeter is still dark with nothing displaying after pressing the power key:

- (1) Check if the power has been connected correctly.
- (2) Check if the main power switch on the back panel has been turned on already.
- (3) Check if the power fuse has blown. Replace it as desired if it has blown.
- (4) Restart the Multimeter after all above steps have been done.
- (5) If the instrument still can't start up properly, please contact SIGLENT.

2. The reading doesn't change when connecting an AC current signal:

- (1) Check if the test lead has been connected to the current jack or LO jack correctly.
- (2) Check if the fuse in the current location on the back panel has blown.
- (3) Check if the measuring location has switched to the DCI or ACI place correctly.
- (4) Check if the input is ACI but the measuring location is in DCI place.

3. The reading doesn't change when connecting a DC current signal:

- (1) Check if the test lead has been connected to the current jack or LO jack correctly.
- (2) Check if the fuse in the current location on the back panel has blown.
- (3) Check if the measuring location has switched to the DCI or ACI place correctly.
- (4) Check if the input is DCI but the measuring location is in ACI place.

4. USB Disks can't be recognized by the instrument.

- (1) Check if the USB disk can work properly.
- (2) Make sure the used USB disk is of Flash type. The instrument doesn't support USB disks of hard disk type.
- (3) Check if the capacity of the used USB disk is too large. The Multimeter is recommended not to use USB disks which exceed 8GB.
- (4) After restarting the instrument, insert the USB disk again to inspect.
- (5) If you still can't use the USB disk properly, please contact SIGLENT.

Chapter 5 Appendix

Appendix A: Accessories

Standard Accessories:

- A Power Cord that fits the standard of destination country.
- Two test leads (black and red)
- An USB Cable
- One backup fuses
- A Quick Start
- A CD-ROM

NOTE:

- We suggest that the length of USB data wire and LAN cable connected to the instrument should be less than 3m to avoid affecting the product performance.
- All the accessories are available by contacting your local **SIGLENT** office.

Appendix B: Warranty summary

SIGLENT warrants that the products that it manufactures and sells will be free from defects in materials and workmanship for a period of three years from the date of shipment from an authorized **SIGLENT** distributor. If a product proves defective within the respective period, **SIGLENT** will provide repair or replacement as described in the complete warranty statement.

To arrange for service or obtain a copy of the complete warranty statement, please contact your nearest **SIGLENT** sales and service office. Except as provided in this summary or the applicable warranty statement, **SIGLENT** makes no warranty of any kind, express or implied, including without limitation the implied warranties of merchantability and fitness for a particular purpose. In no event shall **SIGLENT** be liable for indirect, special or consequential damages.

Appendix C: Contact SIGLENT

SIGLENT TECHNOLOGIES CO., LTD.

Address: 3F, NO.4 building, Antongda Industrial Zone, 3rd
Liuxian Road, 68th District, Baoan District, Shenzhen,
P.R. China

Tel: +86-755-36615186

Fax: +86-755-3591582

Post Code: 518101

E-mail: sales@siglent.com

Http://www.siglent.com