



# User Manual

## SDG2000X Series Function/Arbitrary Waveform Generator UM0202X-E02C

2018 SIGLENT TECHNOLOGIES CO., LTD

## Declaration

Copyright © SIGLENT TECHNOLOGIES CO., LTD. All rights reserved.

Without permission, contents in this manual are not allowed to be copied, extracted or translated.

## General Safety Summary

Carefully read the following safety precautions to avoid any personal injuries or damages to the instrument and any product connected to it. To avoid potential hazards, please use the instrument as specified.

**Only qualified technical personnel should service this instrument.**

**Avoid fire or open flame.**

**Use properly rated power line connections.**

Use only the specified power line which has been approved by your local regulatory agency.

**Ground the Instrument.**

The instrument is grounded through the protective ground conductor of the power line. To avoid electric shock, the ground conductor must be connected to the earth ground. Make sure the instrument is grounded correctly before connecting its input or output terminals.

**Connect the signal wire correctly.**

The potential of the signal wire ground is equal to the earth, therefore do not connect the signal wire to a high voltage. Do not touch the exposed contacts or components.

**Observe all terminal ratings.**

To avoid fire or electric shock, please observe all ratings and sign instructions on the instrument. Before connecting the instrument, please read the manual carefully to gain more information about the ratings.

**Do not operate with suspected failures.**

If you suspect that the product is damaged, please let only qualified service personnel check it.

**Avoid circuit or wire exposure.**

Do not touch exposed contacts or components when the power is on.

**Do not operate in wet/damp conditions.**

**Do not operate in an explosive atmosphere.**

**Keep the surface of the instrument clean and dry.**

## Safety Terms and Symbols

**Terms used on the instrument.** Terms may appear on the instrument:

**DANGER:** Indicates an injury or hazard that may immediately happen.

**WARNING:** Indicates an injury or hazard that may not immediately happen.

**CAUTION:** Indicates that a potential damage to the instrument or other property might occur.

**Symbols used on the instrument.** Symbols may appear on the instrument:



**Hazardous**

**Voltage**



**Protective**

**Earth Ground**



**Warning**



**Chassis**

**Ground**



**Power**

**Switch**

## Résumé sur la sécurité en générale

Lisez attentivement les consignes de sécurité suivantes afin d'éviter toute blessure personnelle ou des dommages à l'instrument et à tout produit qui lui est connecté. Pour éviter tout danger, veuillez utiliser l'instrument comme spécifié.

**Seul un technicien qualifié peut réparer l'instrument.**

**Évitez incendie ou blessure.**

**Utilisez une alimentation appropriée** — Utilisez uniquement une alimentation qui a été approuvé par l'Etat.

**Mettez à la terre l'instrument** — L'instrument est relié à la terre par le câble de terre protecteur de l'alimentation. Pour éviter tout choc électrique, le conducteur de terre doit être relié à la terre. Assurez-vous que l'instrument est mis à la terre correctement avant de connecter ses bornes d'entrée ou de sortie.

**Connectez le câble de signalisation correctement** — Le potentiel du câble de signalisation est égal à la terre, ainsi, il ne faut pas connecter le câble de signalisation à une haute tension. Ne touchez pas les contacts ou les composants apparents.

**Jetez un coup d'œil à toutes les notes concernant les terminaux**— Pour éviter incendie ou choc électrique, veuillez jeter un coup d'œil à toutes les notes et signaux portés sur l'instrument. Avant de brancher l'instrument, veuillez lire attentivement le manuel pour obtenir davantage d'informations concernant toutes les notations.

**Ne pas faire fonctionner en cas de pannes suspectes** — Si vous pensez que le produit est endommagé, veuillez le faire vérifier par un personnel qualifié.

**Évitez les composants de circuit qui sont apparents** — Ne touchez pas les contacts ou les composants apparents lorsque l'alimentation électrique est branchée.

**Ne pas utiliser dans un milieu humide.**

**Ne pas utiliser dans une atmosphère explosive.**

**Gardez la surface de l'appareil propre et sèche.**

### **Termes et symboles de sécurité**

**Termes utilisés sur l'instrument.** Termes qu'on peut trouver sur l'instrument:

**ATTENTION:** signifie qu'il y a risque de blessures directes ou de danger.

**WARNING:** signifie qu'il y a risque de danger ou de blessure mais pas dans l'immédiat.

**CAUTION:** signifie qu'un dommage éventuel concernant l'instrument ou tout autre bien peut se produire.

**Symboles utilisés sur l'instrument.** On peut voir ces symboles sur le produit:



**Danger**  
**Tension**



**Mise à la**  
**terre**



**Attention**



**Terre**



**Commutateur**  
**d'alimentation**

---

# Introduction of SDG2000X

The manual covers the following 3 models of SDG2000X Series Function/Arbitrary Waveform Generators: SDG2042X, SDG2082X and SDG2122X.

SIGLENT's SDG2000X is a series of dual-channel function/arbitrary waveform generators with specifications of up to 120MHz maximum bandwidth, 1.2GSa/s sampling rate and 16-bit vertical resolution. The proprietary TrueArb & EasyPulse techniques help to solve the weaknesses inherent in traditional DDS generators when generating arbitrary, square and pulse waveforms. Using these techniques the SDG2000X provides users with a variety of high fidelity, low jitter signals in order to meet the growing requirements for a multitude of complex applications.

## Key Features

- ◆ Dual-channel, 120MHz maximum bandwidth, 20Vpp maximum output amplitude, output with 80dB dynamic range
- ◆ High-performance sampling system with 1.2GSa/s sampling rate and 16-bit vertical resolution. No detail in your waveforms will be lost
- ◆ Innovative TrueArb technology, based on a point-by-point architecture, supports any 8pts~8Mpts Arb waveform with a sampling rate in range of 1 $\mu$ Sa/s~75MSa/s
- ◆ Innovative Easy Pulse technology, capable of generating lower jitter Square or Pulse waveforms, brings a wide range and extremely high precision in pulse width and rise/fall times adjustment
- ◆ A variety of analog and digital modulation types: AM、DSB-AM、FM、PM、FSK、ASK、PSK and PWM
- ◆ Sweep and Burst functions

- ◆ Harmonic waveforms generating function
- ◆ Waveforms combining function
- ◆ High precision Frequency Counter
- ◆ 196 kinds of built-in arbitrary waveforms
- ◆ Standard interfaces: USB Host, USB Device (USBTMC) , LAN (VXI-11)  
Optional interface: GPIB
- ◆ 4.3" touch screen display for easier operation



# Catalog

General Safety Summary.....	III
Introduction of SDG2000X.....	VII
1 Quick Start .....	1
1.1 Handle Adjustment.....	2
1.2 The Front/Rear Panel .....	3
1.3 To Select a Waveform.....	8
1.4 To Set Modulation/Sweep/Burst .....	12
1.5 To Turn On/Off Output .....	14
1.6 To Use Numeric Input .....	15
1.7 To Use Common Function Keys.....	16
2 Front Panel Operations .....	17
2.1 To Set Sine Waveform .....	18
2.2 To Set Square Waveform .....	23
2.3 To Set Ramp Waveform .....	26
2.4 To Set Pulse Waveform .....	28
2.5 To Set Noise Waveform .....	32
2.6 To Set DC Waveform .....	36
2.7 To Set Arbitrary Waveform.....	37
2.8 To Set Harmonic Function .....	48
2.9 To Set Modulation Function.....	51
2.9.1 AM.....	52
2.9.2 DSB-AM.....	55
2.9.3 FM.....	57
2.9.4 PM.....	59
2.9.5 FSK .....	61
2.9.6 ASK.....	63
2.9.7 PSK.....	65
2.9.8 PWM.....	67
2.10 To Set Sweep Function.....	70
2.11 To Set Burst Function .....	75
2.12 To Store and Recall .....	81

2.12.1	Storage System .....	82
2.12.2	File Type.....	84
2.12.3	File Operation .....	85
2.13	To Set Utility Function .....	89
2.13.1	System Settings .....	91
2.13.2	Test/Cal .....	99
2.13.3	Frequency Counter .....	104
2.13.4	Output.....	107
2.13.5	CH Copy/Coupling.....	110
2.13.6	Remote Interface .....	115
2.13.7	Sync Output .....	121
2.13.8	Clock Source.....	123
2.13.9	Mode .....	124
2.13.10	Overvoltage Protection .....	126
3	Examples .....	127
3.1	Example 1: Generate a Sine Waveform .....	128
3.2	Example 2: Generate a Square Waveform .....	130
3.3	Example 3: Generate a Ramp Waveform .....	132
3.4	Example 4: Generate a Pulse Waveform.....	134
3.5	Example 5: Generate a Noise .....	136
3.6	Example 6: Generate a DC Waveform .....	137
3.7	Example7: Generate a Linear Sweep Waveform .....	138
3.8	Example 8: Generate a Burst Waveform .....	140
3.9	Example 9: Generate an AM Modulation Waveform .....	142
3.10	Example 10: Generate a FM Modulation Waveform .....	144
3.11	Example 11: Generate a PM Modulation     Waveform .....	146
3.12	Example 12: Generate a FSK Modulation     Waveform .....	148
3.13	Example 13: Generate an ASK Modulation Waveform .....	150
3.14	Example 14: Generate a PSK Modulation Waveform .....	152
3.15	Example 15: Generate a PWM Modulation Waveform.....	154
3.16	Example 16: Generate a DSB-AM Modulation Waveform .....	156
4	Troubleshooting .....	158
4.1	General Inspecting.....	158

4.2	Troubleshooting .....	159
5	Service and Support .....	160
5.1	Maintenance summary .....	160
5.2	Contact SIGLENT .....	161
6	Appendix .....	162
	Appendix A: Accessories .....	162
	Appendix B: Daily Maintenance and Cleaning .....	163



# 1 Quick Start

This chapter covers the following topics:

- Handle Adjustment
- The Front/Rear Panel
- To Select a Waveform
- To Set Modulation/Sweep/Burst
- To Turn On/Off Output
- To Use Numeric Input
- To Use Common Function Keys

## 1.1 Handle Adjustment

To adjust the handle position of SDG2000X, please grip the handle by the sides and pull it outward. Then, make the handle rotate to the desired position.

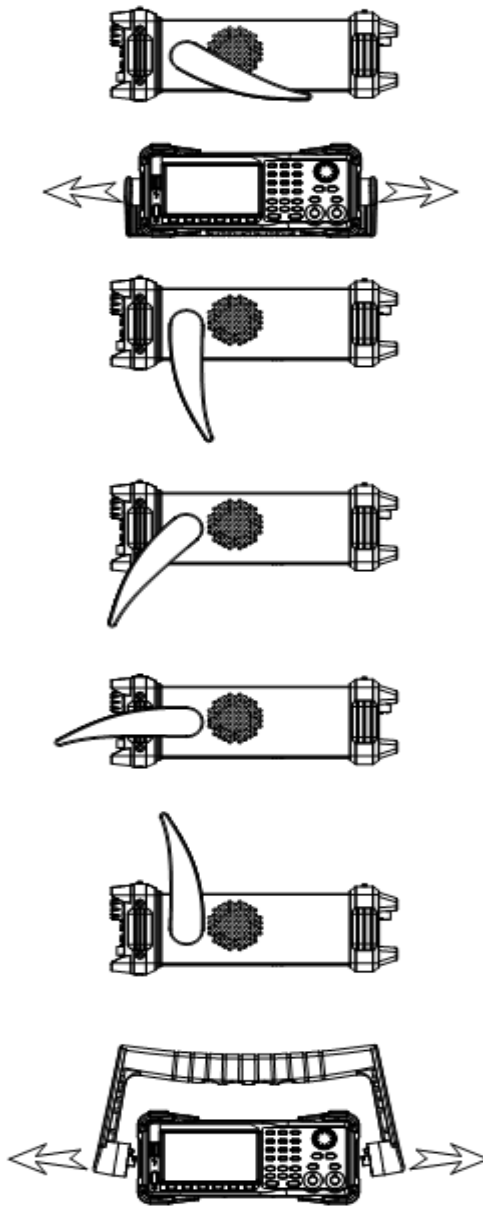

Figure 1-1 Viewing Position and Carrying Position

## 1.2 The Front/Rear Panel

This chapter will provide a brief introduction and description for the operation and functions of the front/rear panel.

### Front Panel

SDG2000X has a clear and simple front panel which includes 4.3 inch touch screen, menu softkeys, numeric keyboard, knob, function keys, arrow keys, and channel control area, etc.

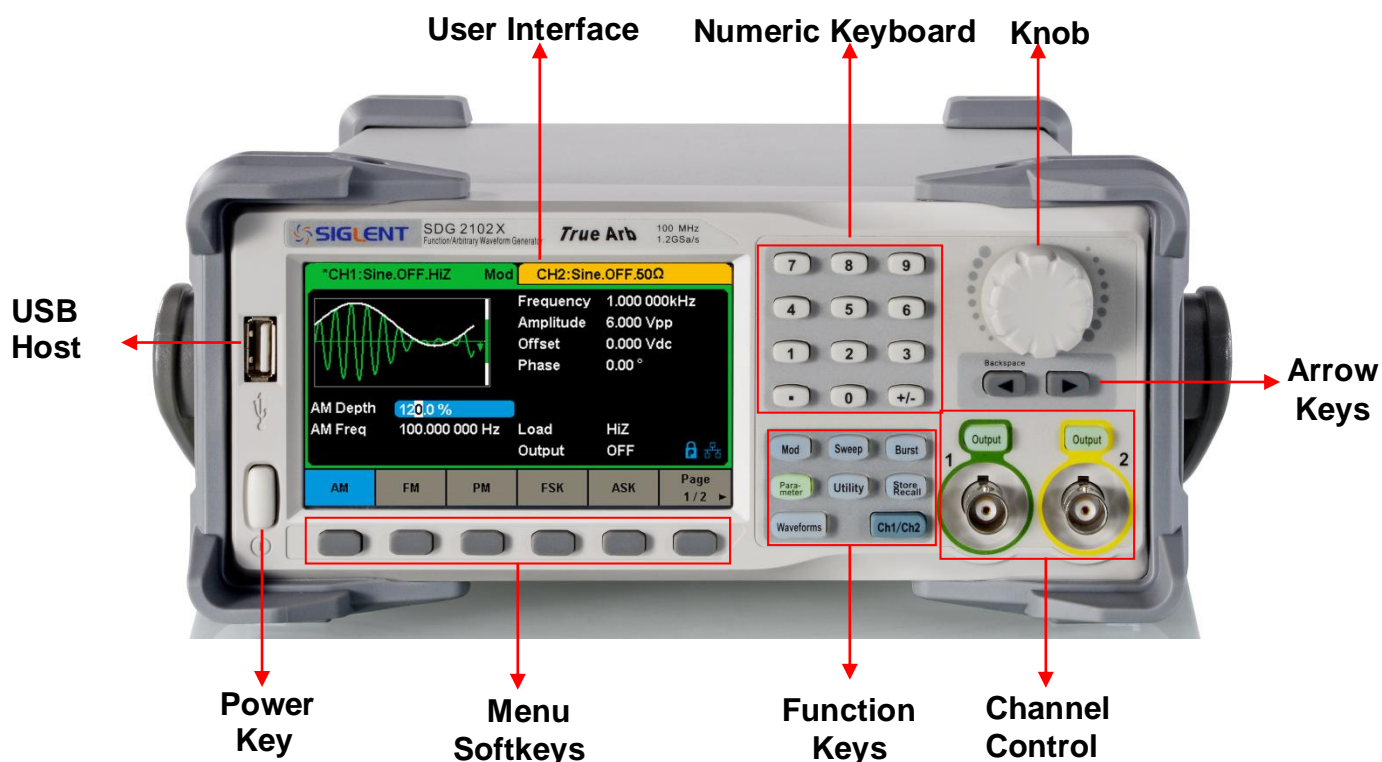

Figure 1-2 Front Panel of SDG2000X

## Rear Panel

The rear panel provides multiple interfaces, including Counter, 10MHz In/Out, Aux In/Out, LAN, USB Device, Earth Terminal and AC Power Supply Input.

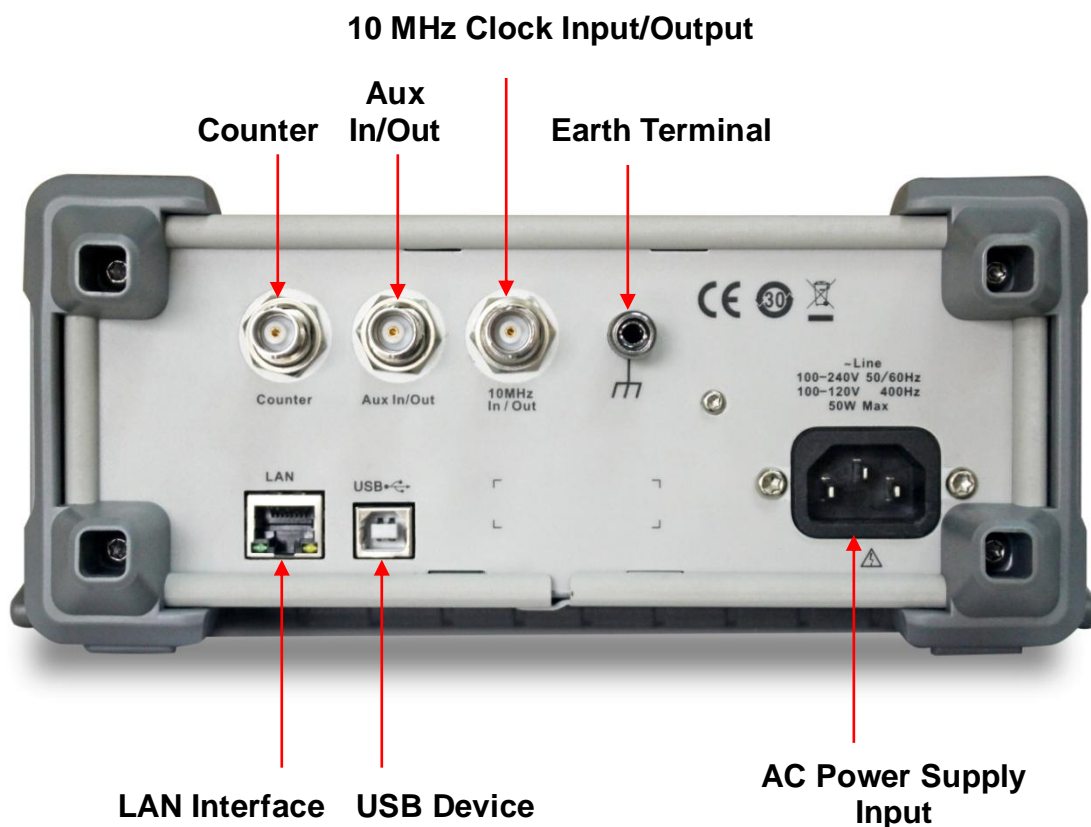

Figure 1-3 Rear Panel of SDG2000X



## Touch Screen Display

SDG2000X can only display parameters and waveform of one channel at a time. The picture below shows the interface when CH1 chooses AM modulation of sine waveform. The information displayed may vary depending on the function selected.

The entire screen of the SDG2000X is a touch screen. You can use your finger or touch pen to control the instrument. Most functions and selections can be chosen using the touch screen in a similar manner to the front panel keys and knob.

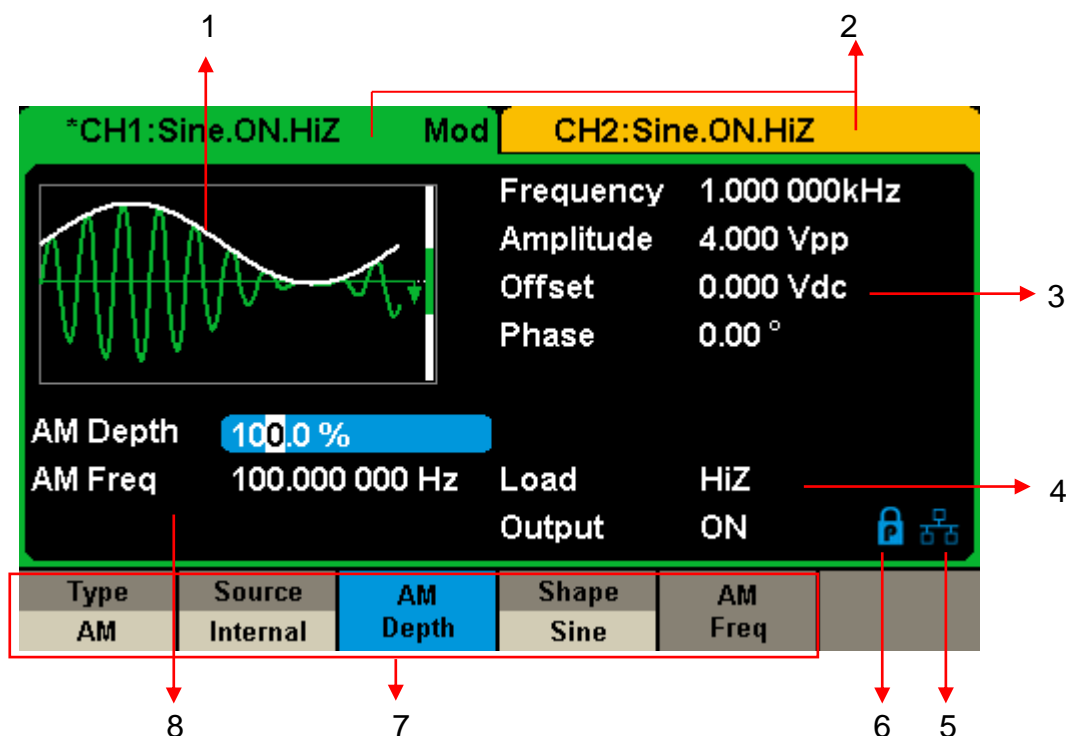

Figure 1-4 Touch Screen Display

### 1. Waveform Display Area

Displays the currently selected waveform of each channel.

### 2. Channel Status Bar

Indicates the selected status and output configuration of the channels.

### 3. Basic Waveform Parameters Area

Shows the current waveform's parameters of each channel. Press Parameter and select the corresponding softkey to highlight the parameter to configure. Then use number keys or knob to change the parameter value.

### 4. Channel Parameters Area

Displays the load and output settings of the currently selected channel.

**Load** ----Value of the output load, as selected by the user.

Press **Utility** → **Output** → **Load**, then use the softkeys, number keys or knob to change the parameter value; or continue pressing the corresponding output key for two second to switch between High Impedance and 50Ω.

High Impedance: display HiZ.

Load: display impedance value (the default is 50Ω and the range is 50Ω to 100kΩ).

Note: This setting does not actually change the instrument's output impedance of 50Ω but rather is used to maintain amplitude accuracy into different load values.

**Output** ----Channel output state.

After pressing corresponding channel output control port, the current channel can be turned on/off.

### 5. LAN Status Icon

SDG2000X will show different prompt messages based on the current network status.



This mark indicates LAN connection is successful.



This mark indicates there is no LAN connection or LAN connection is unsuccessful.

### 6. Mode Icon

SDG2000X will show different prompt messages based on the current mode.



This mark indicates current mode is Phase-locked.



This mark indicates current mode is Independent.

### **7. Menu**

Shows the menu corresponding to the displayed function. For example, Figure 1-4 Touch Screen Display shows the parameters of “AM modulation”.

### **8. Modulation Parameters Area**

Shows the parameters of the current modulation function. After selecting the corresponding menu, use number keys or knob to change the parameter value.

### 1.3 To Select a Waveform

Press **Waveforms** to enter the menu as Figure 1-5 shows. The example below will help familiarize with the waveform selection settings.

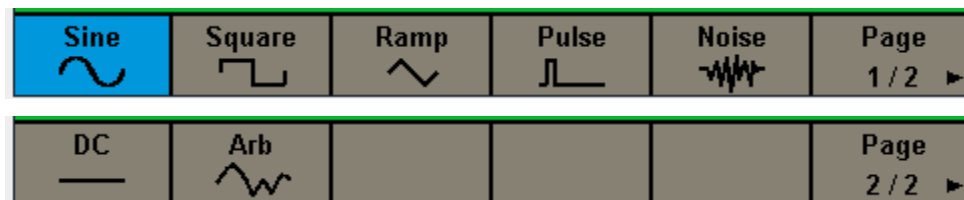

Figure 1-5 Waveform Selections

1. Press **Waveforms** key and then press **Sine** softkey. The SDG2000X can generate sine waveforms with frequencies from 1 $\mu$ Hz to 120MHz. By setting Frequency/Period, Amplitude/High level, Offset/Low level and Phase, a sine signal with different parameters can be generated.

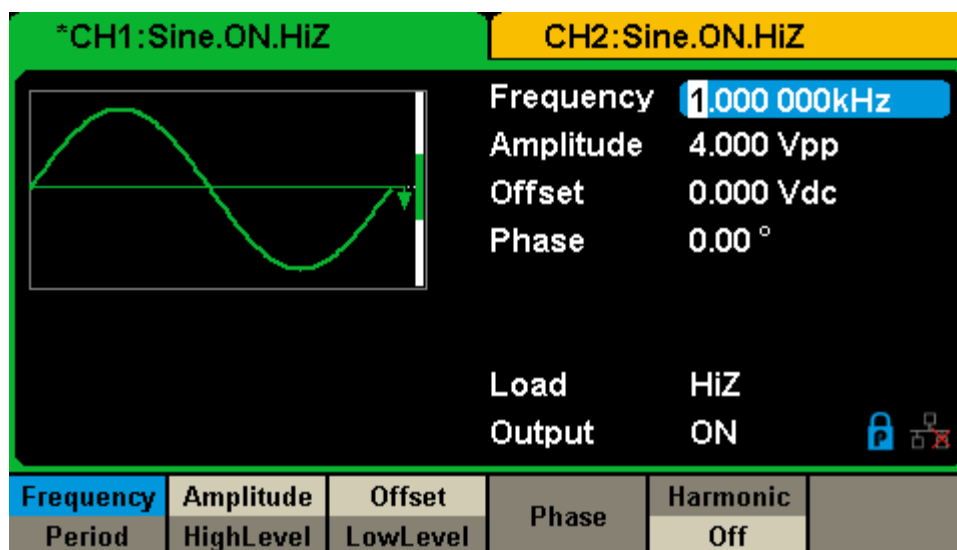

Figure 1-6 Sine Display Interface

2. Press **Waveforms** key and then press **Square** softkey. The generator can generate square waveforms with frequencies from 1 $\mu$ Hz to 25MHz and variable duty cycle. By setting Frequency/Period, Amplitude/High level, Offset/Low level, Phase and DutyCycle, a square waveform with different parameters can be generated.

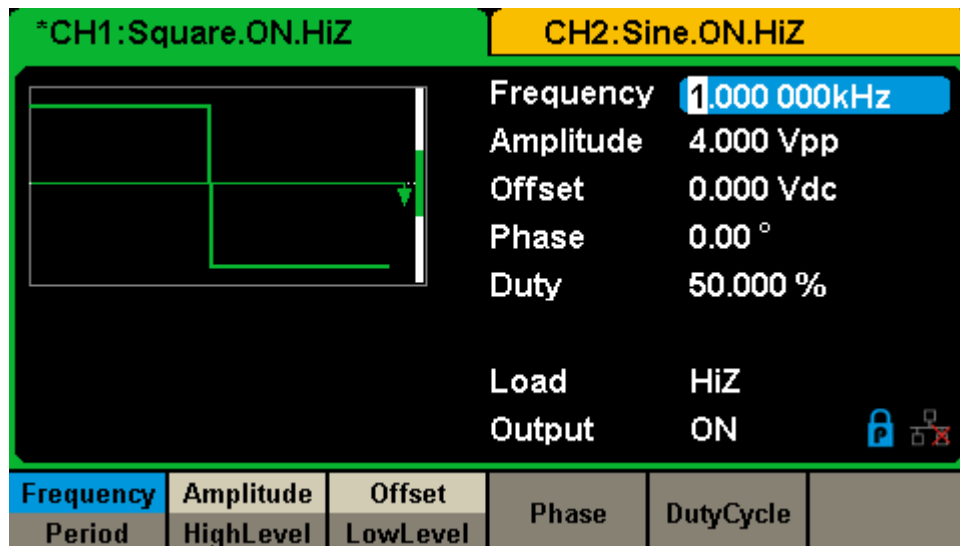

Figure 1-7 Square Display Interface

- Press **Waveforms** key and then press **Ramp** softkey. The generator can generate ramp waveforms with frequencies from 1 $\mu$ Hz to 1MHz and variable symmetry. By setting Frequency/Period, Amplitude/High level, Offset/Low level, Phase and Symmetry, a ramp waveform with different parameters can be generated.

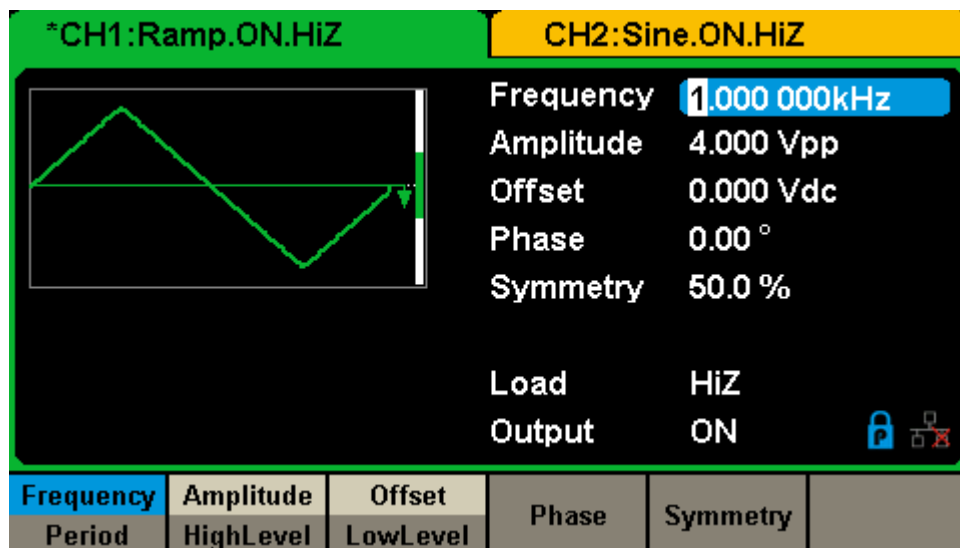

Figure 1-8 Ramp Display Interface

- Press **Waveforms** key and then press **Pulse** softkey. The generator can generate pulse waveforms with frequencies from 1 $\mu$ Hz to 25 MHz and variable pulse width and rise/fall times. By setting Frequency/Period, Amplitude/High level, Offset/Low level, PulWidth/Duty, Rise/Fall and Delay,

a pulse waveform with different parameters can be generated.

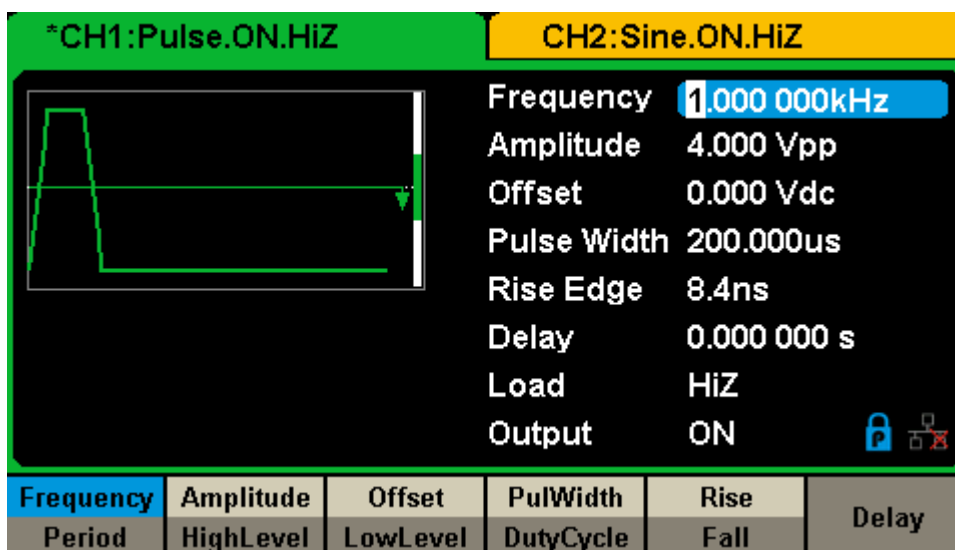

Figure 1-9 Pulse Display Interface

5. Press **Waveforms** key and then press **Noise** softkey. The generator can generate noise with bandwidth from 20MHz to 120MHz. By setting Stdev and Mean, noise with different parameters can be generated.

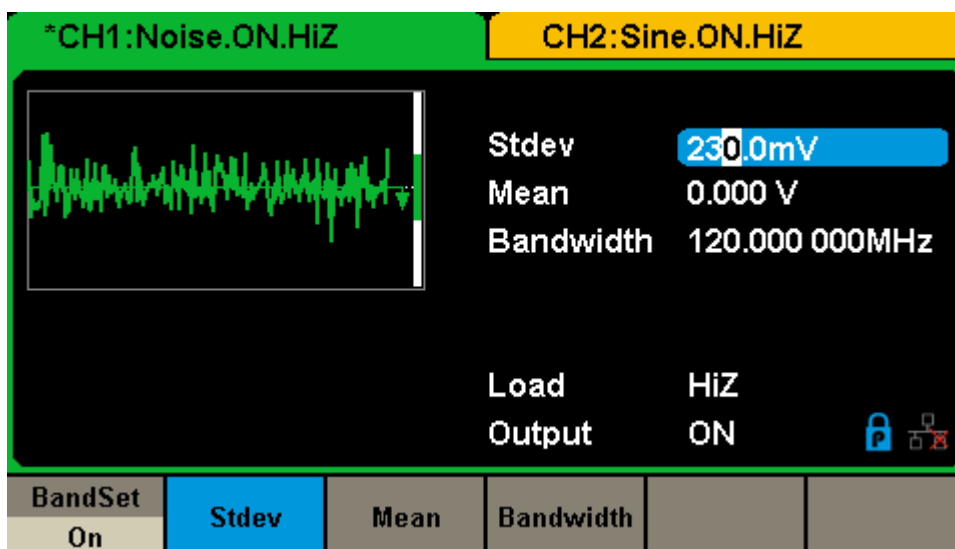

Figure 1-10 Noise Display Interface

6. Press **Waveforms** key and then press **Page 1/2**, last press the **DC** softkey. The generator can generate a DC signal with a level up to  $\pm 10V$  into a HighZ load or  $\pm 5V$  into a  $50\Omega$  load.

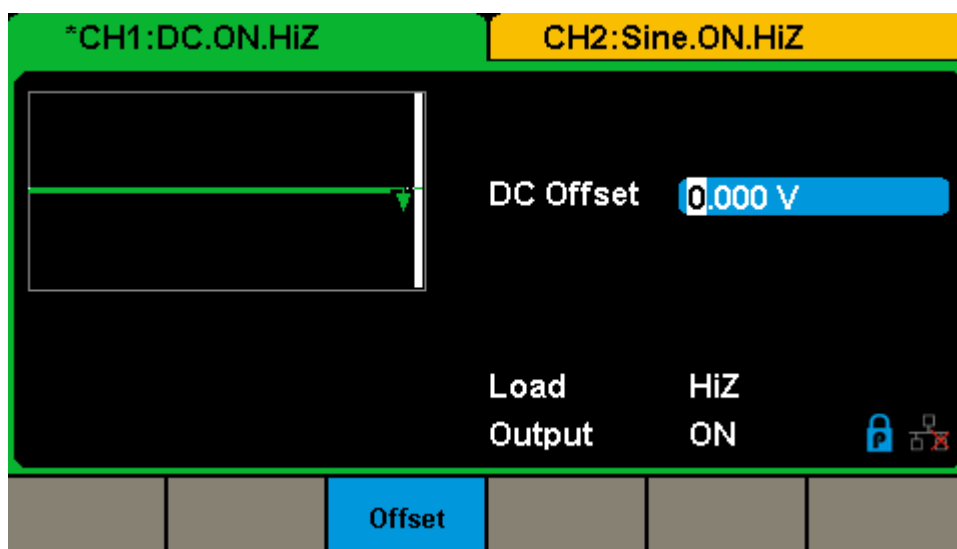

Figure 1-11 DC Display Interface

- Press **Waveforms** key and then press **Page 1/2**, last press the **Arb** softkey. The generator can generate repeatable arbitrary waveforms with length from 8 to 8M points and frequencies up to 20MHz. By setting Frequency/Period, Amplitude/High level, Offset/Low level, Phase and Arb Mode, an arbitrary signal with different parameters can be generated.

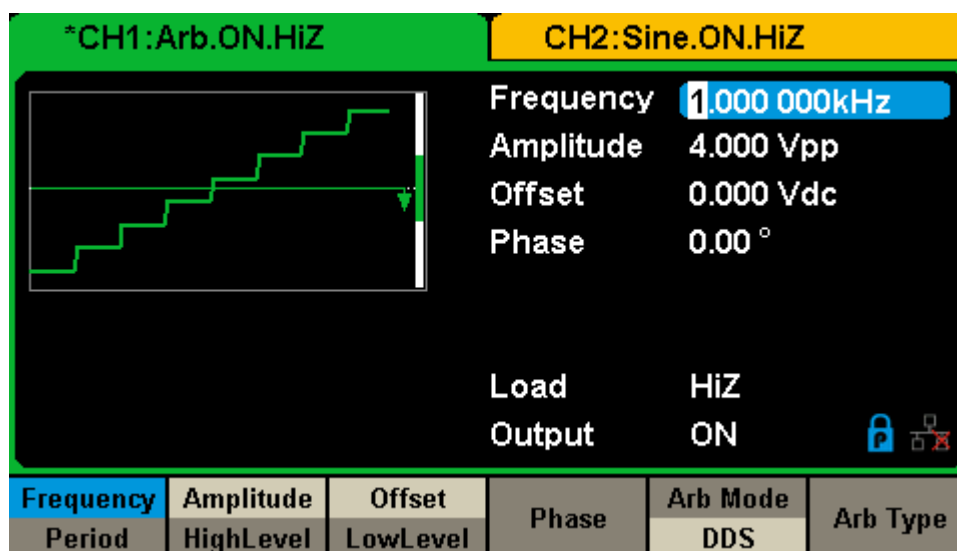

Figure 1-12 Arbitrary Waveform Display Interface

## 1.4 To Set Modulation/Sweep/Burst

As shown in Figure 1-13, there are three keys on the front panel which are used for modulation, sweep and burst settings. The instructions below will help to explain these functions.

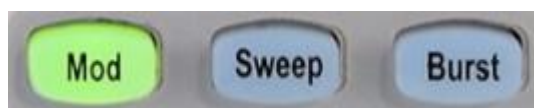

Figure 1-13 Modulate/Sweep/Burst Key

### 1. Press **Mod**, the Modulation function will be enabled.

The modulated waveform can be changed by modifying the parameters such as Type, Source, AM Depth, AM Freq, Shape, etc. The SDG2000X can modulate waveforms using AM, FM, PM, ASK, FSK, PSK, PWM and DSB-AM, etc. Pulse waveforms can only be modulated using PWM. Noise and DC waveforms cannot be modulated.

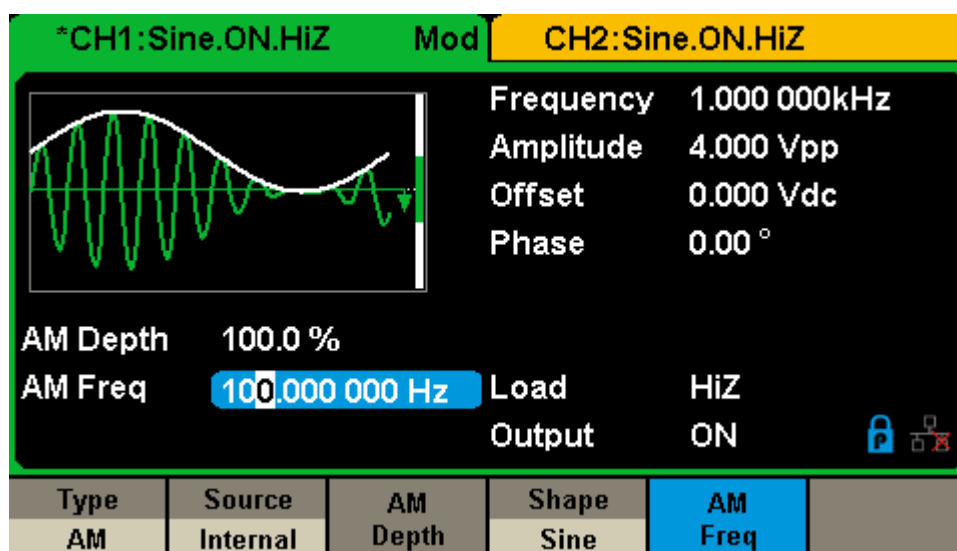

Figure 1-14 Modulation Display Interface

### 2. Press **Sweep**, the Sweep function will be enabled.

Sine, square, ramp and arbitrary waveforms support the sweep function. In sweep mode, the SDG2000X can generate signals with variable frequency. The available range of sweep time is from 1ms to 500s. The trigger source can be “Internal”, “External” or “Manual”.



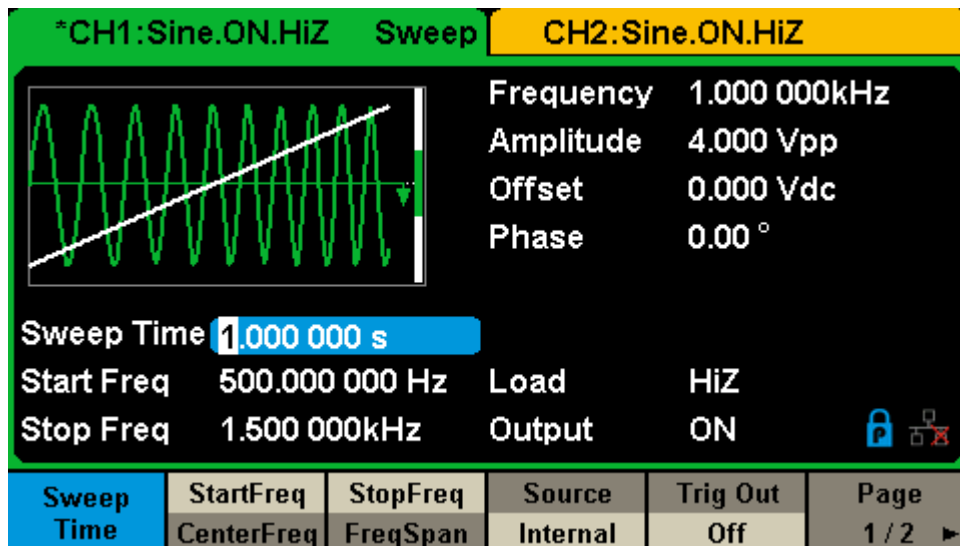

Figure 1-15 Sweep Waveform Display Interface

3. Press **Burst**, the Burst function will be enabled.

Burst signals for sine, square, ramp, pulse or arbitrary waveforms may be generated. Start Phase ranges from 0° to 360° and Burst Period ranges from 1μs to 1000s.

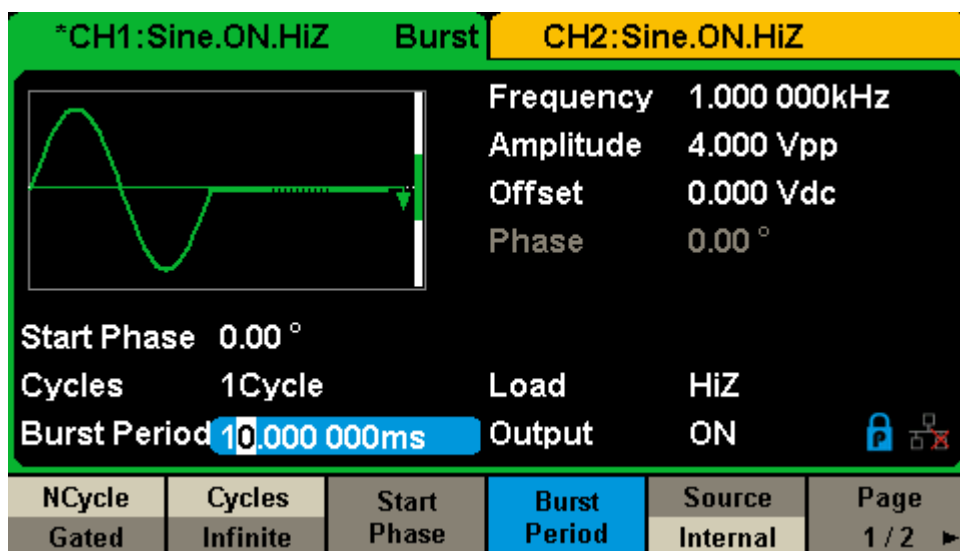

Figure 1-16 Burst Waveform Display Interface

## 1.5 To Turn On/Off Output

As shown in Figure 1-17 there are two keys on the right side of the operation panel which are used to enable / disable the output of the two channels. Choose a channel and press the corresponding **Output** key, the key backlight will be lighted and the output will be enabled. Press the **Output** key again, the key backlight will be extinguished and the output will be disabled.

Keep pressing the corresponding output key for two seconds to switch between High Impedance and 50Ω load.



Figure 1-17 Output Keys

## 1.6 To Use Numeric Input

As shown in Figure 1-18, there are three sets of keys on the front panel, which are arrow keys, knob and numeric keyboard. The instructions below will help to familiarize you with the digital input selection.



Figure 1-18 Front Panel Digital Input

1. The numeric keyboard is used to enter the parameter's value.
2. The knob is used to increase (clockwise) or decrease (counterclockwise) the current digit when setting parameters
3. When using knob to set parameters, the arrow keys are used to select the digit to be modified; When using numeric keyboard to set parameters, the left arrow key is used as a Backspace function.

## 1.7 To Use Common Function Keys

As shown in Figure 1-19, there are five keys on the operation panel, which are labeled Parameter, Utility, Store/Recall, Waveforms, and Ch1/Ch2. The instructions below will help to familiarize you with these functions.



Figure 1-19 Waveforms Utility and Parameter Key

1. The **Parameter** key makes it convenient for the operator to set the parameters of basic waveforms directly.
2. The **Utility** key is used to set the auxiliary system function, such as output configurations, interface setting, system setting information, performing the instrument self-test and reading the calibration information, etc.
3. The **Store/Recall** key is used to store and recall waveform data and configuration information.
4. The **Waveforms** key is used to select basic waveforms.
5. The **Ch1/Ch2** key is used to switch the currently selected channel between CH1 and CH2. After start-up, CH1 is selected as default. At this point, press the key to select CH2.

## 2 Front Panel Operations

Up to now, you have got a brief understanding about SDG2000X with the front/rear panel, every function control area and keys. You should also know how to set your Function/Arbitrary Waveform Generator for your usage. If you are not familiar with these operations, you are suggested to read chapter one '**Quick Start**' again.

This chapter covers the following topics:

- To Set Sine
- To Set Square
- To Set Ramp
- To Set Pulse
- To Set Noise
- To Set DC
- To Set Arbitrary
- To Set Harmonic Function
- To Set Modulation Function
- To Set Sweep Function
- To Set Burst Function
- To Store and Recall
- To Set Utility Function

It is recommended that you read this chapter carefully so as to understand the SDG2000X's versatile waveform setting functions and additional operation methods.

## 2.1 To Set Sine Waveform

Press **Waveforms** key to select the waveform function and then press the **Sine** softkey. The sine waveform parameters are set by using the sine operation menu.

The parameters available for sine waveforms include frequency/period, amplitude/high level, offset/low level and phase. Different sine signals can be generated by setting these parameters. As shown in Figure 2-1, in the soft key menu, select **Frequency**. The frequency parameter area is highlighted in the parameter display window, and users can set the frequency value here.

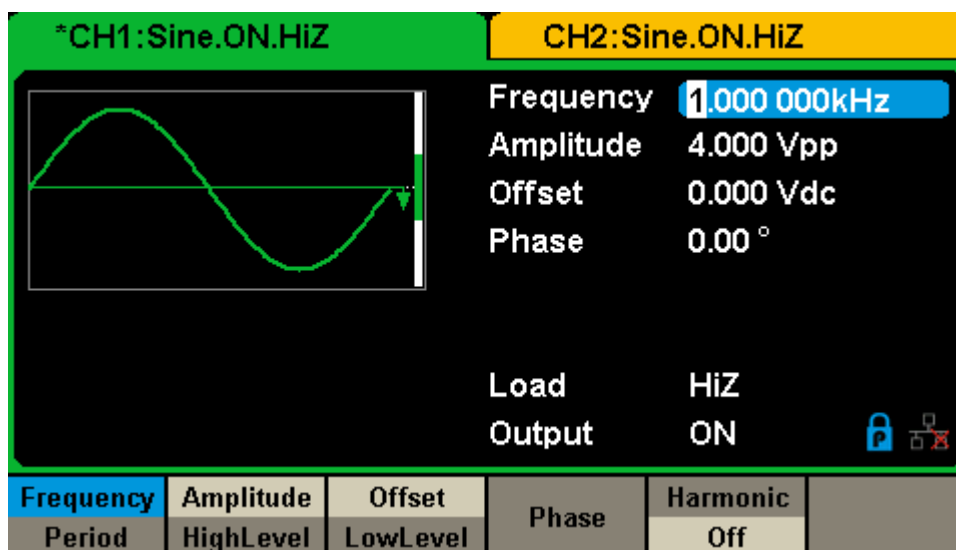

Figure 2-1 Sine Parameters Display Interface

Table 2-1 Menu Explanations of Sine Waveform

		<b>Explanations</b>
Frequency/ Period		Set the signal frequency or period; The current parameter will be switched at a second press.
Amplitude/ HighLevel		Set the signal amplitude or high level; The current parameter will be switched at a second press.
Offset/ LowLevel		Set the signal offset or low level; The current parameter will be switched at a second press.
Phase		Set the phase of the signal.

## To Set the Frequency/Period

Frequency is one of the most important parameters of basic waveforms. For different instrument models and waveforms, the available ranges of frequency are different. For detailed information, please refer to “SDG2000X Datasheet”. The default frequency is 1kHz.

1. Press **Waveforms** → **Sine** → **Frequency**, to set the frequency parameter.

The frequency shown on the screen when the instrument is powered on is the default value or the set value of last power down. If Period (rather than Frequency) is the desired parameter, press Frequency/Period again to enter the Period mode. The current value for the waveform’s period is now displayed in inverse color. Press the Frequency/Period key once again to return to the Frequency entry mode.

2. Input the desired frequency.

Use the numeric keyboard to input the parameter value directly, and press the corresponding key to select the parameter unit. Or use the arrow keys to select the digit to edit, and then use the knob to change its value.

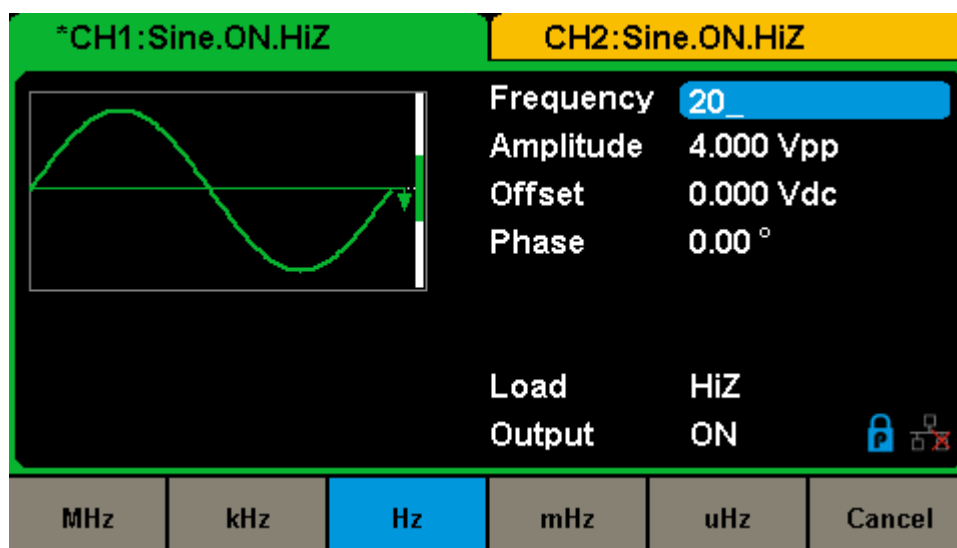

Figure 2-2 Setting the Frequency

### Note:

When using the numeric keyboard to enter the value, the left arrow key can be used to move the cursor backward and delete the value of the previous digit.

### To Set the Amplitude

The amplitude setting range is limited by the “Load” and “Frequency/Period” settings. For detailed information, please refer to “SDG2000X Datasheet”.

1. Press **Waveforms** → **Sine** → **Amplitude**, to set the amplitude.

The amplitude shown on the screen when the instrument is powered on is the default value or the set value of last power down. If setting the waveform’s high level is desired, press the **Amplitude/HighLevel** key again to switch into the high level parameter (the current operation is displayed in inverse color).

2. Input the desired amplitude.

Use the numeric keyboard to input the parameter value directly, and press the corresponding key to select the parameter unit. Or use the arrow keys to select the digit to edit, and then use the knob to change its value.

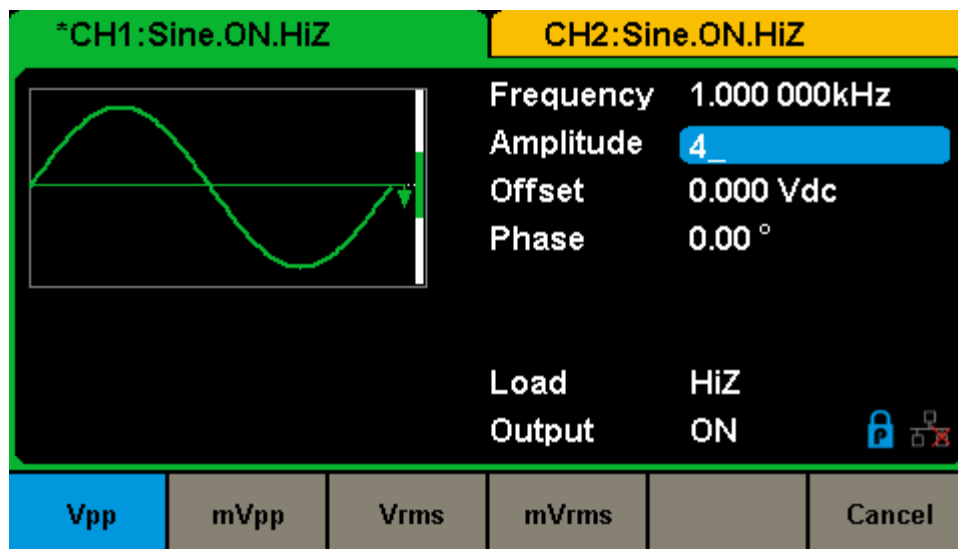

Figure 2-3 Setting the Amplitude

### To Set the Offset

The offset setting range is limited by the “Load” and “Amplitude/HighLevel”



settings. For detailed information, please refer to “SDG2000X Datasheet”. The default value is 0Vdc.

1. Press **Waveforms** → **Sine** → **Offset**, to set the offset.

The offset shown on the screen when the instrument is powered on is the default value or the set value of last power down. If you want to set the waveform by low level, press the **Offset/LowLevel** key again, to switch into the low level parameter (the current operation is displayed in inverse color).

2. Input the desired offset.

Use the numeric keyboard to input the parameter value directly, and press the corresponding key to select the parameter unit. Or use the arrow keys to select the digit to edit, and then use the knob to change its value.

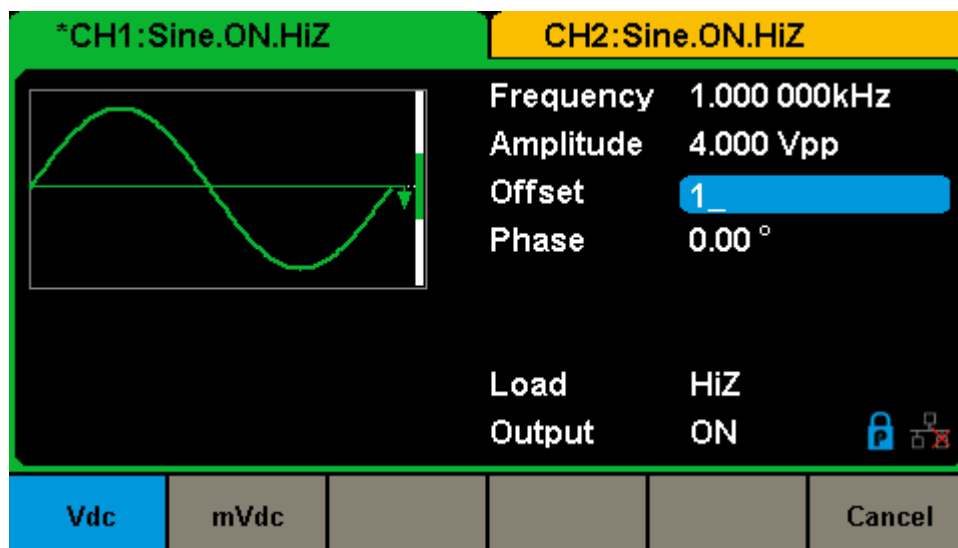

Figure 2-4 Setting the Offset

### To Set the Phase

1. Press **Waveforms** → **Sine** → **Phase**, to set the phase.

The Phase shown on the screen when the instrument is powered on is the default value or the set value of last power down.

2. Input the desired phase.

Use the numeric keyboard to input the parameter value directly and press the corresponding key to select the parameter unit. Or use the arrow keys to select the digit to edit, and then use the knob to change its value.

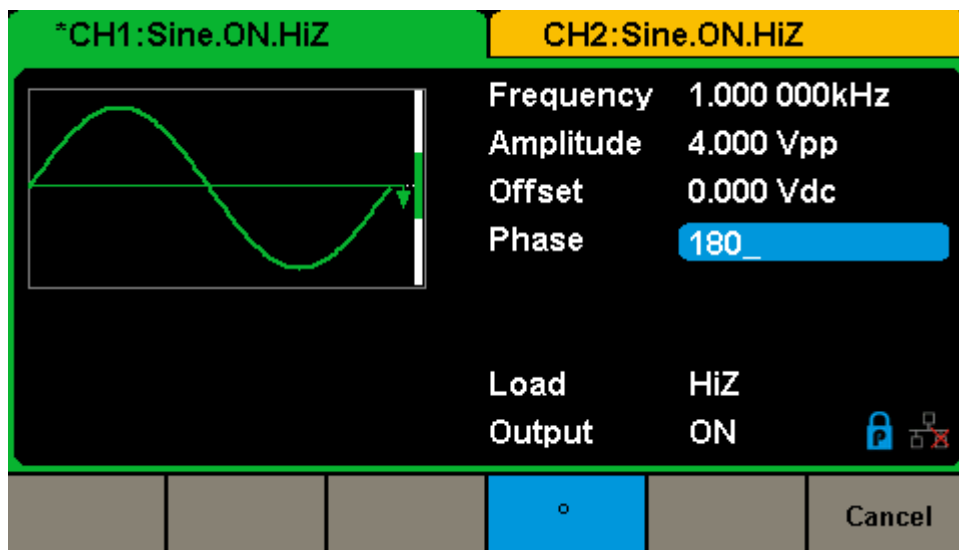

Figure 2-5 Setting the Phase

**Note:**

When the independent mode is enabled, the phase parameter cannot be modified

## 2.2 To Set Square Waveform

Press **Waveforms** key to select the waveform function, and press the **Square** softkey. The square waveform parameters are set by using the Square operation menu.

The parameters of square waveforms include frequency/period, amplitude/high level, offset/low level, phase and duty. As shown in Figure 2-6, select **DutyCycle**. The duty cycle parameter area is highlighted in the parameter display window, and users can set the duty cycle value here.

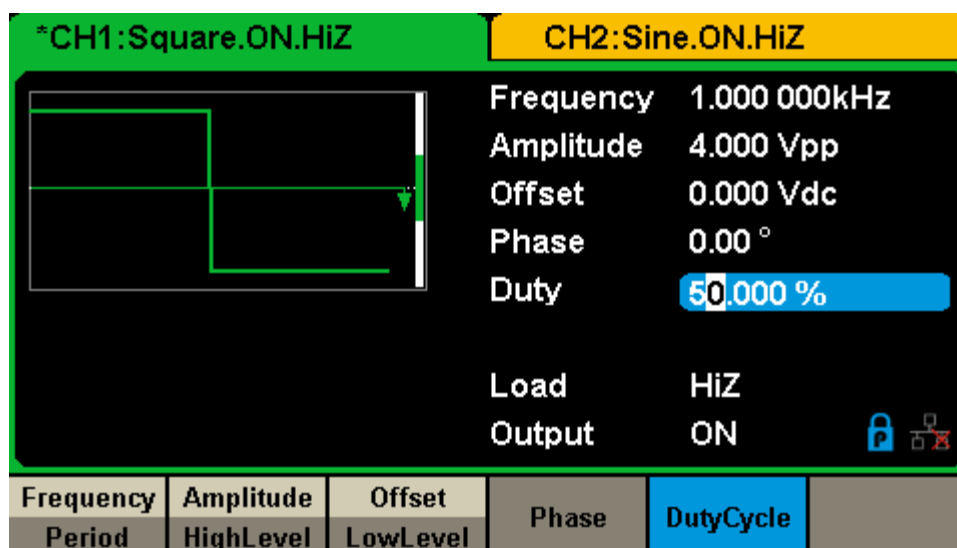

Figure 2-6 Square Parameters Display Interface

Table 2-2 Menu Explanations of Square Waveform

Function Menu	Settings	Explanation
Frequency/ Period		Set the signal frequency or period; The current parameter will be switched at a second press.
Amplitude/ HighLevel		Set the signal amplitude or high level; The current parameter will be switched at a second press.
Offset/ LowLevel		Set the signal offset or low level; The current parameter will be switched at a second press.
Phase		Set the phase of the signal.
DutyCycle		Set the duty cycle for square waveform.

## To Set the Duty Cycle

**Duty Cycle:** The ratio of the amount of time the pulse is in the high state and the waveform's period.

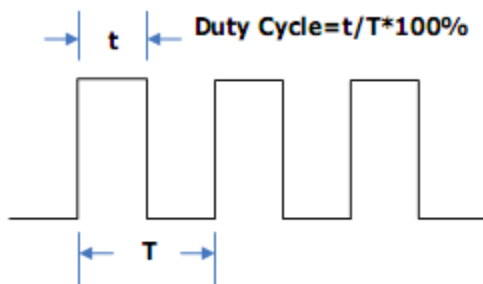

The duty cycle setting range is limited by the “Frequency/Period” setting. For detailed information, please refer to “SDG2000X Datasheet”. The default value is 50%.

1. Press **Waveforms** → **Square** → **DutyCycle**, to set the duty cycle.

The duty cycle shown on the screen when the instrument is powered on is the default value or the set value of last power down.

2. Input the desired Duty Cycle.

Use the numeric keyboard to input the parameter value directly and press the corresponding key to select the parameter unit. Or use the arrow keys to select the digit to edit, and then use the knob to change its value. The generator will change the waveform immediately.

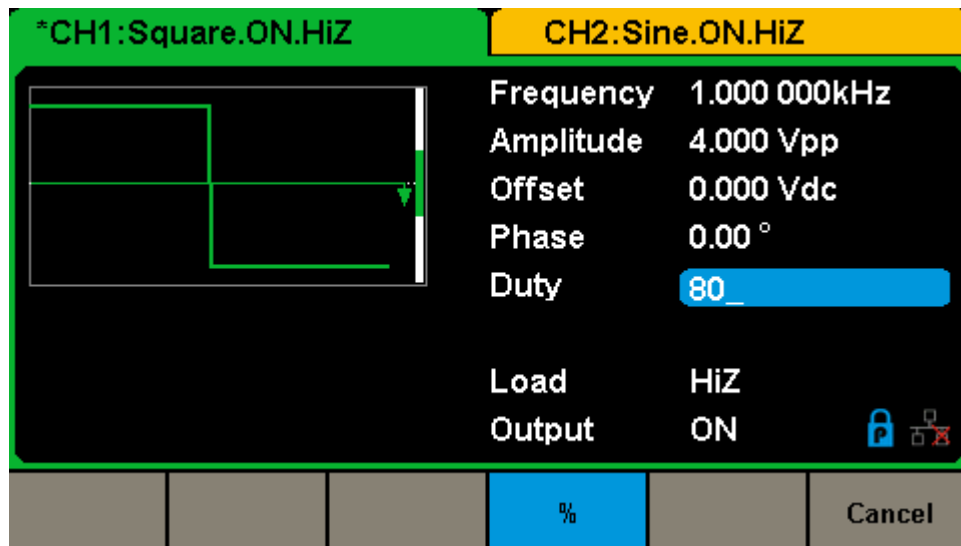

Figure 2-7 Setting the Duty Cycle

**Note:**

The methods of setting other parameters of square signal are similar to sine waveform function.

## 2.3 To Set Ramp Waveform

Press **Waveforms** key to select the waveform function, and press the **Ramp** softkey. The ramp waveform parameters are set by using the ramp operation menu.

The parameters for ramp waveforms include frequency/period, amplitude/high level, offset/low level, phase and symmetry. As shown in Figure 2-8, in the soft key menu, select **Symmetry**. The symmetry parameter area is highlighted in the parameter display window, and users can set the symmetry value here.

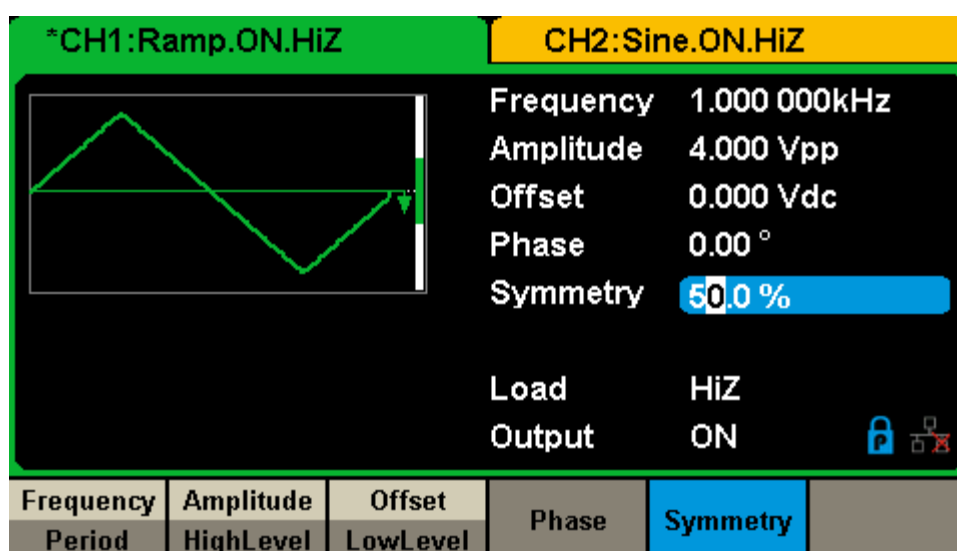

Figure 2-8 Ramp Parameters Display Interface

Table 2-3 Menu Explanations of Ramp Waveform

Function Menu	Settings	Explanation
Frequency/ Period		Set the signal frequency or period; The current parameter will be switched at a second press.
Amplitude/ HighLevel		Set the signal amplitude or high level; The current parameter will be switched at a second press.
Offset/ LowLevel		Set the signal offset or low level; The current parameter will be switched at a second press.
Phase		Set the phase of the signal.
Symmetry		Set the symmetry for ramp waveform.

### To Set the Symmetry

**Symmetry:** The percentage that the rising period takes up the whole Period.

**Input Range:** 0~100%

**Default Value:** 50%

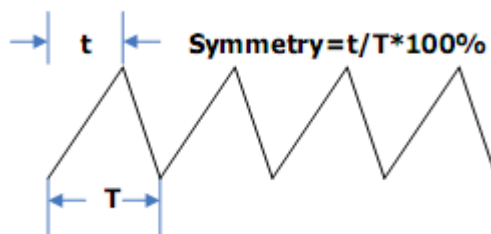

1. Press **Waveforms** → **Ramp** → **Symmetry**, to set the symmetry.

The symmetry shown on the screen when the instrument is powered on is the default value or the set value of last power down.

2. Input the desired Symmetry.

Use the numeric keyboard to input the parameter value directly, and press the corresponding key to select the parameter unit. Or use the arrow keys to select the digit to edit, and then use the knob to change its value. The generator will change the waveform immediately.

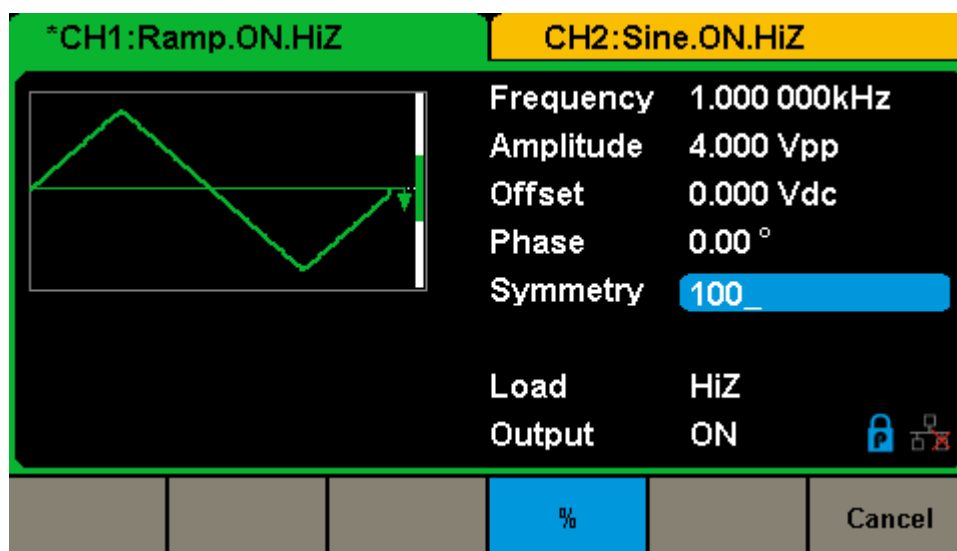

Figure 2-9 Setting the Symmetry

**Note:**

The methods of setting other parameters of ramp signal are similar to sine waveform function.

## 2.4 To Set Pulse Waveform

Press **Waveforms** key to select the waveform function, and press the **Pulse** softkey. The pulse waveform parameters are set by using the pulse operation menu.

The parameters for pulse waveforms include frequency/period, amplitude/high level, offset/low level, width, rise/fall and delay. As shown in Figure 2-10, in the soft key menu, select **PulWidth**. The pulse width parameter area is highlighted in the parameter display window, and users can set the pulse width value here.

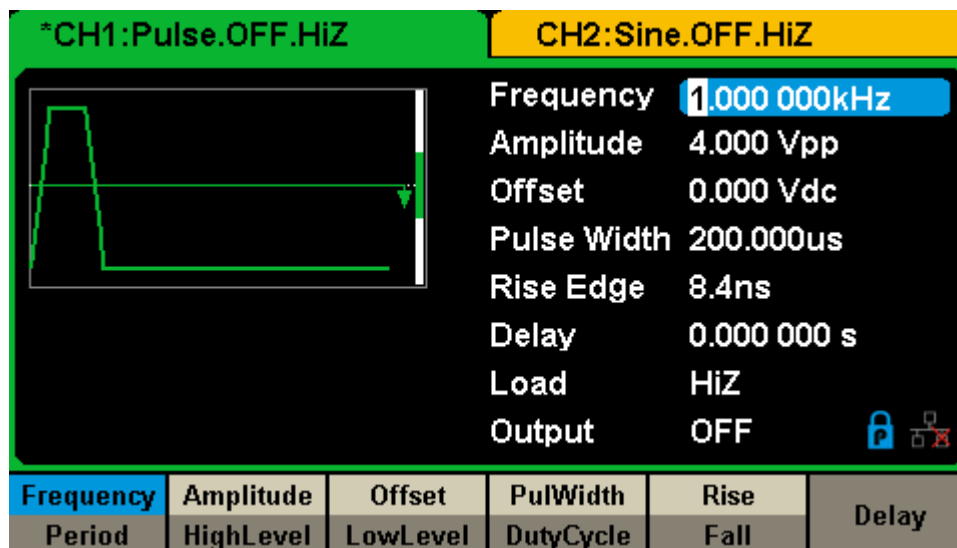

Figure 2-10 Pulse Parameters Display Interface

Table 2-4 Menu Explanations of Pulse Waveform

Function Menu	Settings	Explanation
Frequency/ Period		Set the signal frequency or period; The current parameter will be switched at a second press.
Amplitude/ HighLevel		Set the signal amplitude or high level; The current parameter will be switched at a second press.
Offset/ LowLevel		Set the signal offset or low level; The current parameter will be switched at a second press.
PulWidth/ DutyCycle		Set the signal pulse width or duty cycle; The current parameter will be switched at a second press.
Rise/ Fall		Setting the rise edge or fall edge for pulse waveform. The current parameter will be switched at a second press.



Delay

Setting the delay for pulse waveform.

### To Set the Pulse Width/DutyCycle

Pulse width is defined as the time from the 50% threshold of a rising edge amplitude to the 50% threshold of the next falling edge amplitude (as shown in the figure below). The pulse width setting range is limited by the “Minimum Pulse Width” and “Pulse Period” setting. For detailed information, please refer to “SDG2000X Datasheet”. The default value is 200 $\mu$ s.

Pulse duty cycle is defined as the percentage that the pulse width takes up in the whole period. Pulse duty cycle and pulse width are correlative. Once a parameter is changed, the other will be automatically changed.

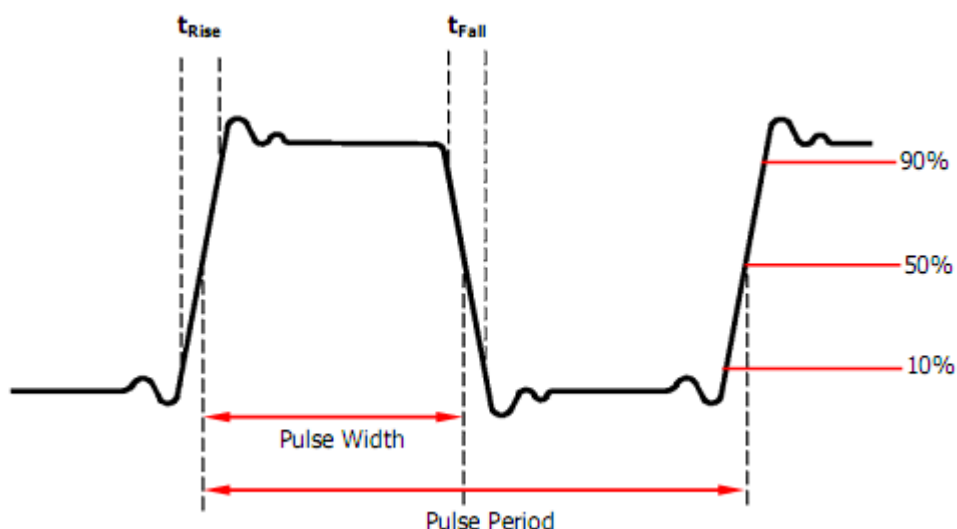

1. Press **Waveforms** → **Pulse** → **PuWidth**, to set the pulse width.

The pulse width shown on the screen when the instrument is powered on is the default value or the set value of last power down. If you want to set the waveform by duty, press the **PuWidth/DutyCycle** key again, to switch into the duty parameter (the current operation is displayed in inverse color).

2. Input the desired Pulse Width.

Use the numeric keyboard to input the parameter value directly, and press the corresponding key to select the parameter unit. Or use the arrow keys to

select the digit to edit, and then use the knob to change its value. The generator will change the waveform immediately.

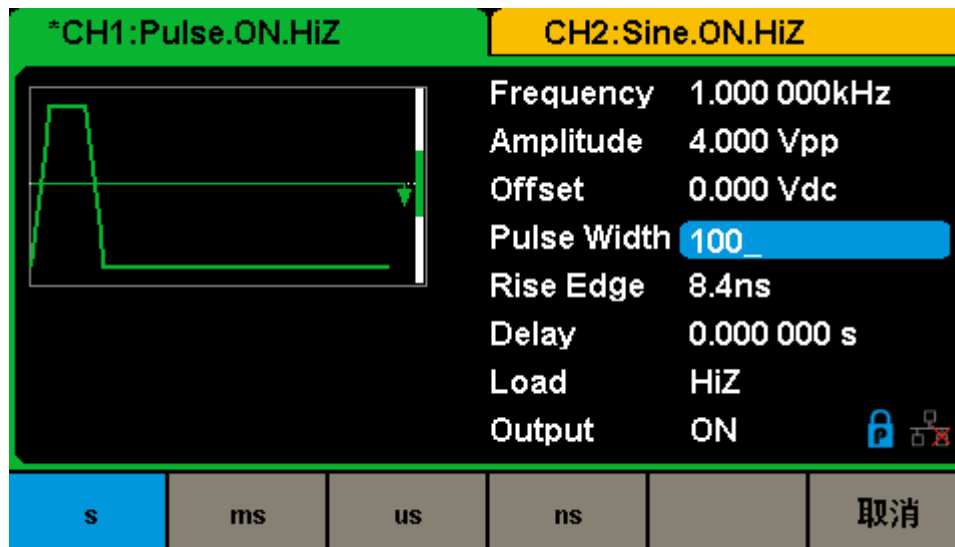

Figure 2-11 Setting the Pulse Width

### To Set the Rise/Fall Edge

Rise edge time is defined as the duration of the pulse amplitude rising from 10% to 90% threshold, while fall edge time is defined as duration of the pulse amplitude moving down from 90% to 10% threshold. The setting of rise/fall edge time is limited by the currently specified pulse width limit. Users can set rise edge and fall edge independently.

1. Press **Waveforms** → **Pulse** → **Rise** to set the rise edge.

The rise edge shown on the screen when the instrument is powered on is the default value or the set value of last power down. If you want to set the waveform by fall edge, press the **Rise/Fall** key again, to switch into the fall edge parameter (the current operation is displayed in inverse color).

2. Input the desired rise edge.

Use the numeric keyboard to input the parameter value directly, and press the corresponding key to select the parameter unit. Or use the arrow keys to select the digit to edit, and then use the knob to change its value. The

generator will change the waveform immediately.

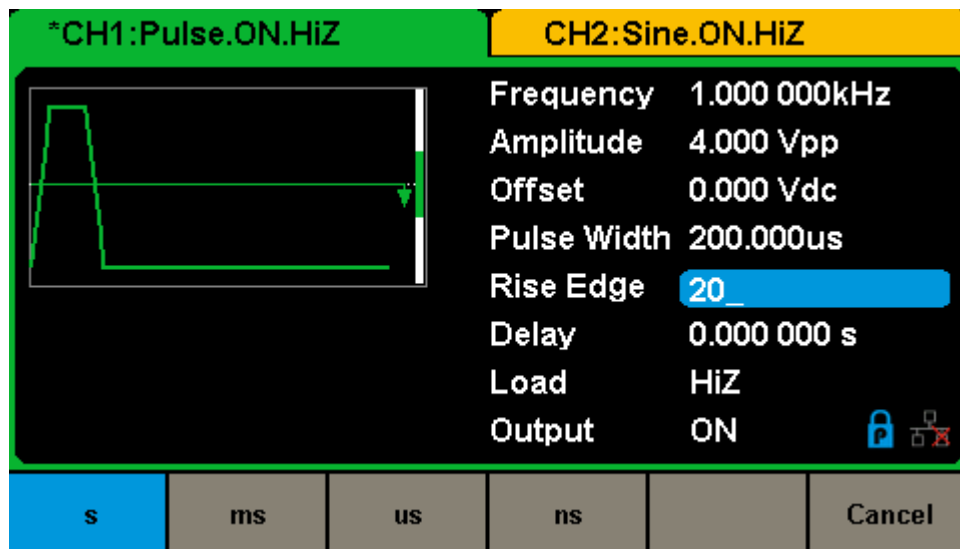

Figure 2-12 Setting the Rise Edge

**Note:**

The methods of setting other parameters of pulse signal are similar to sine waveform function.

## 2.5 To Set Noise Waveform

Press **Waveforms** key to select the waveform function, and press the **Noise** softkey. The noise parameters are set by using the noise operation menu.

The parameters for noise include stdev, mean and bandwidth. As shown in Figure 2-13, in the soft key menu, select **Stdev**. The stdev parameter area is highlighted in the parameter display window, and users can set the stdev value here. Noise is non-periodic signal which has no frequency or period.

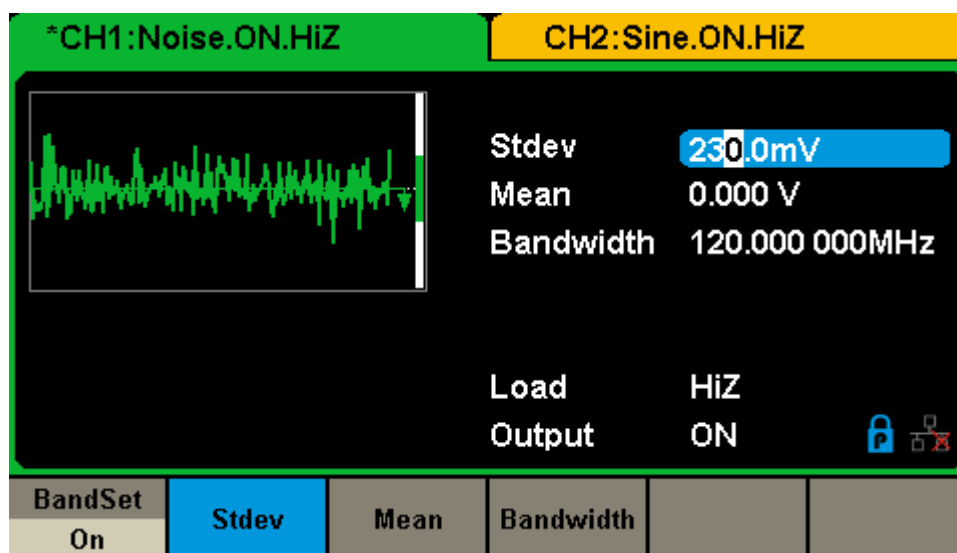

Figure 2-13 Noise Parameters Display Interface

Table 2-5 Menu Explanations of Noise

Function Menu	Settings	Explanation
BandSet		Turn on/off the bandwidth setting.
Stdev		Setting the stdev for noise waveform.
Mean		Setting the mean for noise waveform.
Bandwidth		Setting the bandwidth for noise waveform.

### To Set the Stdev

1. Press **Waveforms** → **Noise** → **Stdev**, to set the stdev.

The stdev shown on the screen when the instrument is powered on is the default value or the set value of last power down.

2. Input the desired stdev.

Use the numeric keyboard to input the parameter value directly, and press the corresponding key to select the parameter unit. Or use the arrow keys to select the digit to edit, and then use the knob to change its value.

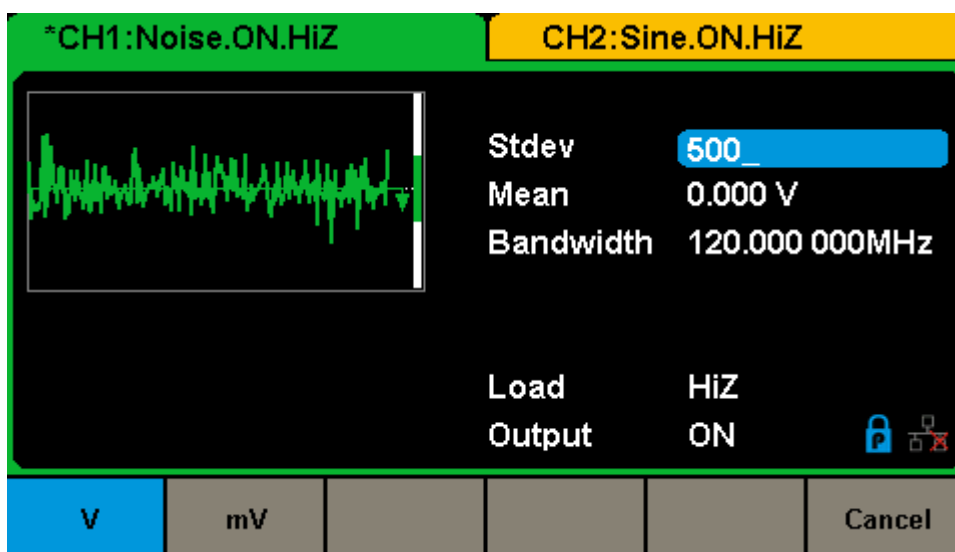

Figure 2-14 Setting the Stdev

### To Set the Mean

1. Press **Waveforms** → **Noise** → **Mean**, to set the mean.

The mean shown on the screen when the instrument is powered on is the default value or the set value of last power down.

2. Input the desired mean.

Use the numeric keyboard to input the parameter value directly, and press the corresponding key to select the parameter unit. Or use the arrow keys to select the digit to edit, and then use the knob to change its value.

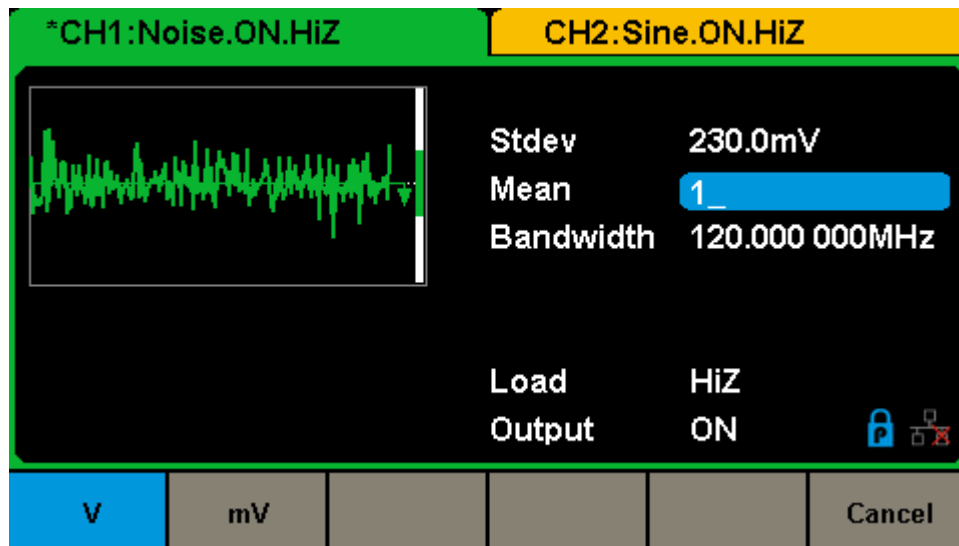

Figure 2-15 Setting the Mean

### To Set the Bandwidth

1. Press **Waveforms** → **Noise** → **BandSet** and choose “On” to set the bandwidth.

The bandwidth shown on the screen when the instrument is powered on is the default value or the set value of last power on. When changing the function, if the current value is valid for the new waveform, it will be used sequentially.

2. Input the desired bandwidth.

Use the numeric keyboard to input the parameter value directly, and press the corresponding key to select the parameter unit. Or you can use the arrow keys to select the digit you want to edit, and then use the knob to change its value.

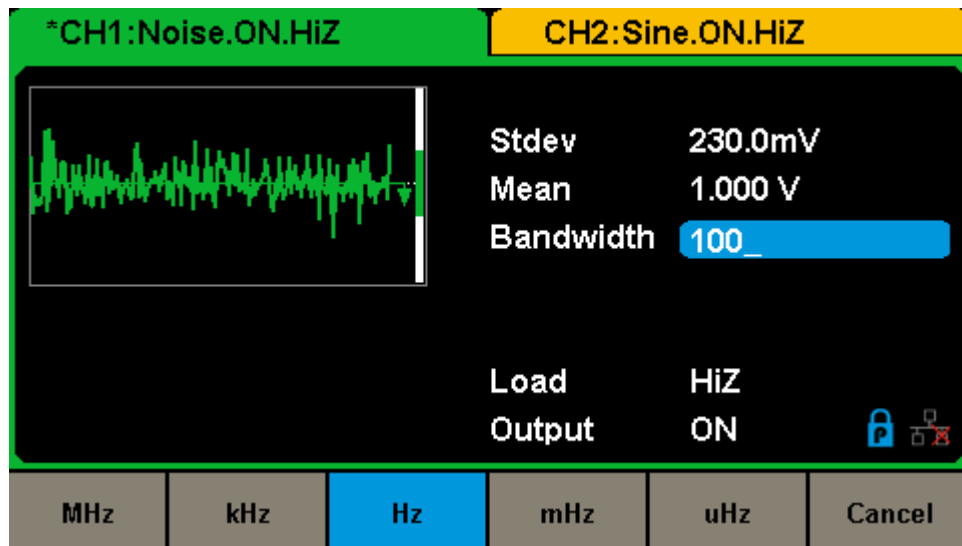

Figure 2-16 Setting the Bandwidth

## 2.6 To Set DC Waveform

Press **Waveforms** → **Page 1/2** → **DC**, to enter the following interface. Please note that there is a 'DC offset' parameter at the middle of the screen.

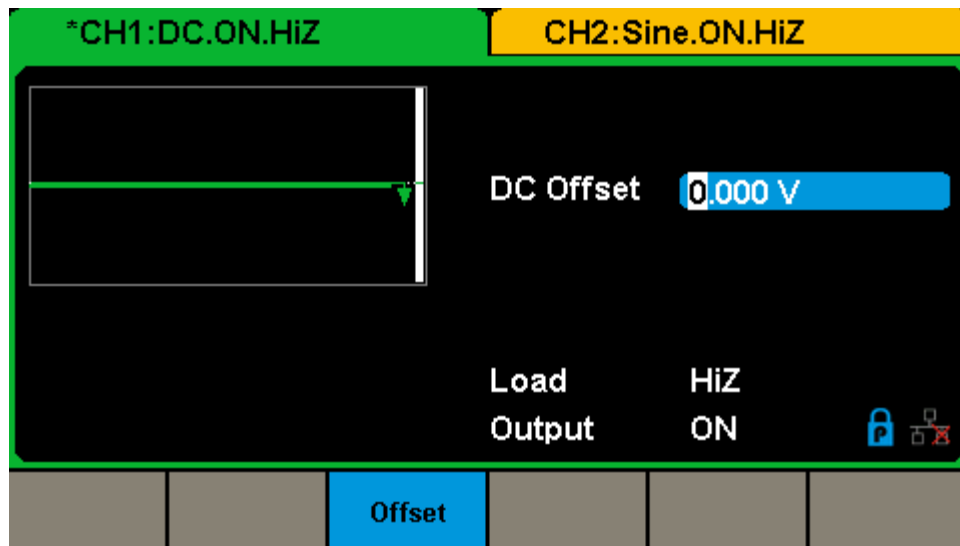

Figure 2-17 DC Setting Interface

**Note:**

The method of setting offset of DC signal is similar to sine waveform function.



## 2.7 To Set Arbitrary Waveform

The Arb signal consists of two types: the system's built-in waveforms and the user-defined waveforms. Built-in waveforms are stored in the internal non-volatile memory. Users may also edit the arbitrary waveform with 8 to 8M data points, namely 8pts to 8Mpts.

### DDS

Choose **Waveforms** → **Page 1/2** → **Arb** → **Arb Mode** and select the “DDS” output mode. The parameters include frequency/period, amplitude/high level, offset/low level and phase.

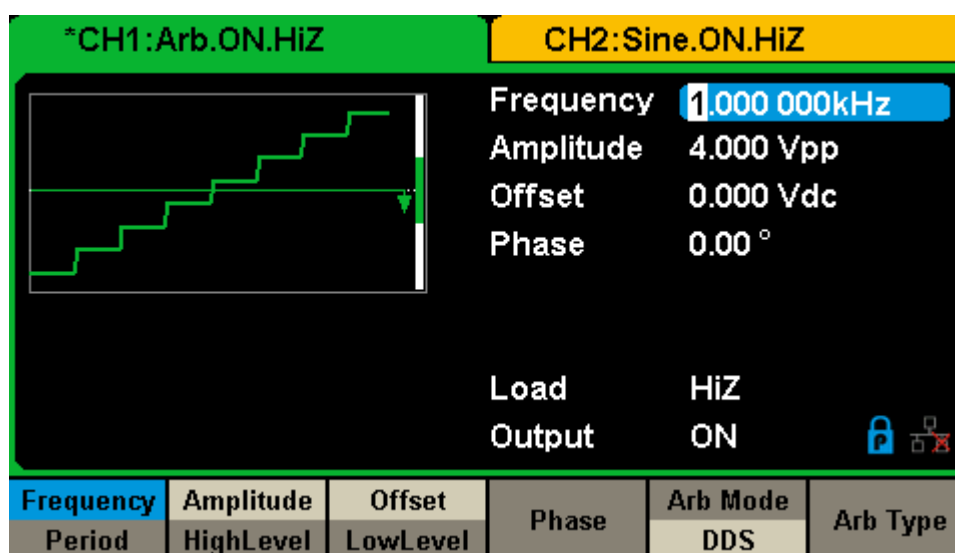

Figure 2-18 Arb Parameters Display Interface (DDS)

Table 2-6 Menu Explanations of Arb Waveform (Page 1/2)

Function menu	Settings	Explanations
Frequency/ Period		Set the signal frequency or period; The current parameter will be switched at a second press.
Amplitude/ HighLevel		Set the signal amplitude or high level; The current parameter will be switched at a second press.
Offset/ LowLevel		Set the signal offset or low level; The current parameter will be switched at a second press.
Phase		Set the phase of the signal.

In DDS output mode, users can set the frequency or period of the arbitrary

waveform. The instrument outputs an arbitrary waveform which is made up of certain points according to the current frequency

### TrueArb

Choose **Waveforms** → **Page 1/2** → **Arb** → **Arb Mode** and select the “TrueArb” output mode. The parameters include sampling rate/frequency, amplitude/high level, offset/ low level and phase.

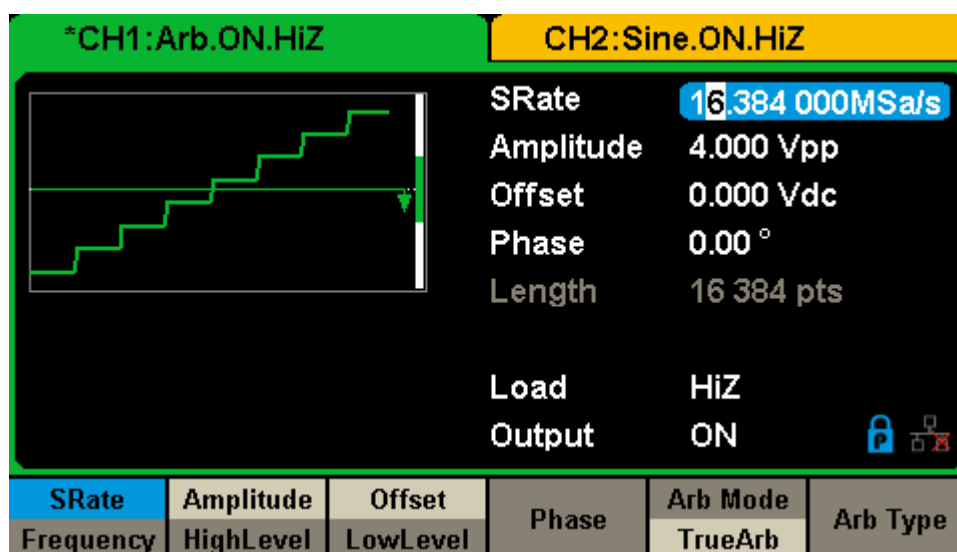

Figure 2-19 Arb Parameters Display Interface (TrueArb)

Table 2-7 Menu Explanations of Arb Waveform (Page 1/2)

Function menu	Settings	Explanations
SRate/ Frequency		Set the signal sampling rate or frequency; The current parameter will be switched at a second press.
Amplitude/ HighLevel		Set the signal amplitude or high level; The current parameter will be switched at a second press.
Offset/ LowLevel		Set the signal offset or low level; The current parameter will be switched at a second press.
Phase		Set the phase of the signal.

In TrueArb output mode, users can set the sampling rate (the output points per second) or frequency of the arbitrary waveform. The instrument outputs an arbitrary waveform point by point according to the current sampling rate.

## To Set the Sampling Rate

1. Press **Waveforms** → **Page 1/2** → **Arb** → **TureArb** → **Srate**, to set the sampling rate parameter.

The sampling rate shown on the screen when the instrument is powered on is the default value or the set value of last power on. When setting the function, if the current value is valid for the new waveform, it will be used sequentially. If you want to set the frequency for the waveform, press **SRate/Frequency** key again, to switch to the frequency parameter (the current operation is displayed in inverse color).

2. Input the desired sampling rate.

Use the numeric keyboard to input the parameter value directly, and press the corresponding key to select the parameter unit. Or you can use the arrow keys to select the digit you want to edit, and then use the knob to change its value.

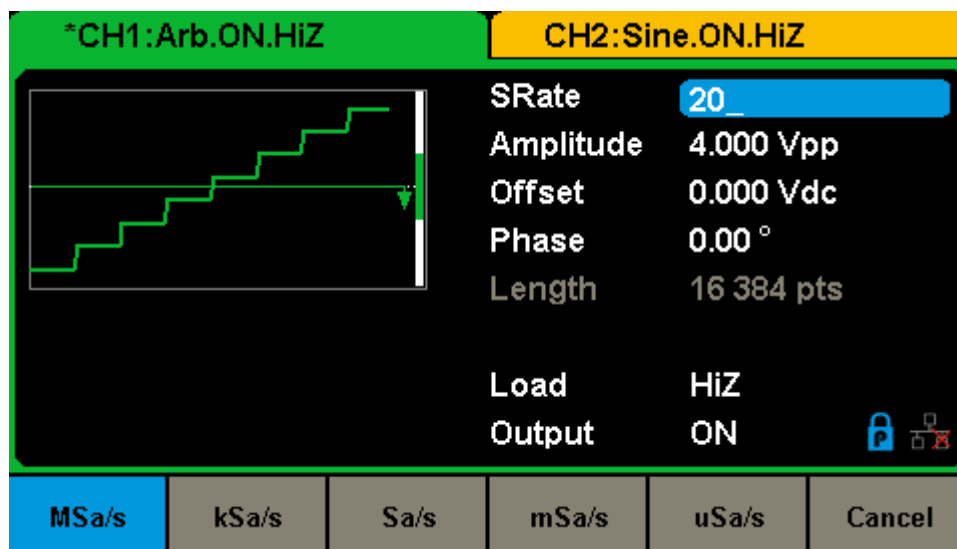

Figure 2-20 Setting the Sampling Rate

### Note:

The methods of setting the parameters of arbitrary signal are similar to sine waveform function.

## To select the built-in Arbitrary Waveform

There are plenty of built-in Arbitrary Waveforms and user-defined Arbitrary Waveforms inside the generator. To select one of them, follow the instructions below.

### 1. To Select the Built-in Waveform

Choose **Waveforms** → **Page 1/2** → **Arb** → **Arb Type** → **Built-In** to enter the following interface, as shown in Figure 2-21.

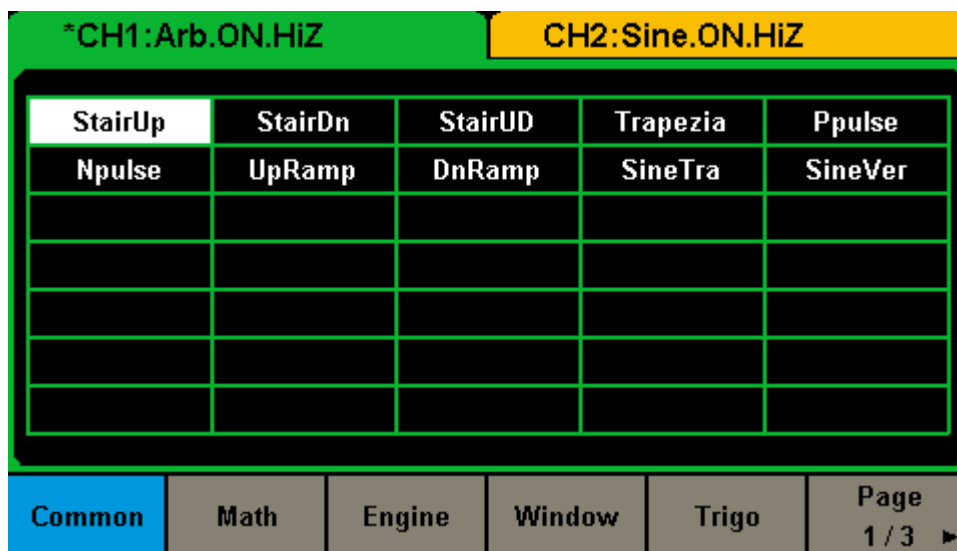

Figure 2-21 Built-in Arbitrary Waveforms

Press **Common**, **Math**, **Engine**, **Window**, **Trigo** or other menus to switch to the desired category (the selected category in the menu bar is highlighted), then rotate the knob or click the touch screen to choose the desired waveform (the selected waveform is highlighted). Select **Accept** or press the knob to recall the corresponding waveform.

Table 2-8 Built-in Waveforms

Item	Waveform	Explanation
Common	StairUp	Stair-up waveform
	StairDn	Stair-down waveform
	StairUD	Stair-up and down waveform
	Trapezia	Trapezia waveform

	Ppulse	Positive pulse
	Npulse	Negative pulse
	UpRamp	UpRamp waveform
	DnRamp	DnRamp waveform
	SineTra	Sine-Tra waveform
	SineVer	Sine-Ver waveform
Math	ExpFall	ExpFall function
	ExpRise	ExpRise function
	LogFall	LogFall function
	LogRise	LogRise function
	Sqrt	Sqrt function
	Root3	Root3 function
	X^2	X <sup>2</sup> function
	X^3	X <sup>3</sup> function
	Airy	Airy function
	Besselj	Bessel I function
	Bessely	Bessel II function
	Dirichlet	Dirichlet function
	Erf	Error function
	Erfc	Complementary error function
	ErfcInv	Inverted complementary error function
	ErfInv	Inverted error function
	Laguerre	4-times Laguerre polynomial
	Legend	5-times Legend polynomial
	Versiera	Versiera
	Sinc	Sinc function
	Gaussian	Gaussian function
	Dlorentz	Dlorentz function
	Haversine	Haversine function
	Lorentz	Lorentz function
	Gauspuls	Gauspuls signal
	Gmonopuls	Gmonopuls signal
	Tripuls	Tripuls signal
Weibull	Weibull distribution	

	LogNormal	LogNormal Gaussian distribution
	Laplace	Laplace distribution
	Maxwell	Maxwell distribution
	Rayleigh	Rayleigh distribution
	Cauchy	Cauchy distribution
Engine	Cardiac	Cardiac signal
	Quake	Analog quake waveform
	Chirp	Chirp signal
	TwoTone	TwoTone signal
	SNR	SNR signal
	AmpALT	Gain oscillation curve
	AttALT	Attenuation oscillation curve
	RoundHalf	RoundHalf Waveform
	RoundsPM	RoundsPM Waveform
	BlaseiWave	Time-velocity curve of explosive oscillation
	DampedOsc	Time-displacement curve of damped oscillation
	SwingOsc	Kinetic energy – time curve of swing oscillation
	Discharge	Discharge curve of NI-MH battery
	Pahcur	Current waveform of DC brushless motor
	Combin	Combination function
	SCR	SCR firing profile
	TV	TV signal
	Voice	Voice signal
	Surge	Surge signal
	Radar	Analog radar signal
	Ripple	Ripple wave of battery
	Gamma	Gamma signal
	StepResp	Step-response signal
	BandLimited	Bandwidth-limited signal
	CPulse	C-Pulse
	CWPulse	CW pulse
	GateVibr	Gate self-oscillation signal
LFMPulse	Linear FM pulse	
MCNoise	Mechanical construction noise	

Window	Hamming	Hamming window
	Hanning	Hanning window
	Kaiser	Kaiser window
	Blackman	Blackman window
	GaussiWin	GaussiWin window
	Triangle	Triangle window (Fejer window)
	BlackmanH	BlackmanH window
	Bartlett-Hann	Bartlett-Hann window
	Bartlett	Bartlett window
	BarthannWin	Modified Bartlett-Hann window
	BohmanWin	BohmanWin window
	ChebWin	ChebWin window
	FlatTopWin	Flat top weighted window
	ParzenWin	ParzenWin window
	TaylorWin	TaylorWin window
TukeyWin	TukeyWin (tapered cosine) window	
Trigo	Tan	Tangent
	Cot	Cotangent
	Sec	Secant
	Csc	Cosecant
	Asin	Arc sine
	Acos	Arc cosine
	Atan	Arc tangent
	ACot	Arc cotangent
	CosH	Hyperbolic cosine
	CosInt	Integral cosine
	Coth	Hyperbolic cotangent
	Csch	Hyperbolic cosecant
	SecH	Hyperbolic secant
	SinH	Hyperbolic sine
	SinInt	Integral sine
	TanH	Hyperbolic tangent
	ACosH	Arc hyperbolic cosine
ASecH	Arc hyperbolic secant	

	ASinH	Arc hyperbolic sine
	ATanH	Arc hyperbolic tangent
	ACsch	Arc hyperbolic cosecant
	ACoth	Arc hyperbolic cotangent
Square 1	SquareDuty01	Square waveform with 1% duty
	SquareDuty02	Square waveform with 2% duty
	SquareDuty04	Square waveform with 4% duty
	SquareDuty06	Square waveform with 6% duty
	SquareDuty08	Square waveform with 8% duty
	SquareDuty10	Square waveform with 10% duty
	SquareDuty12	Square waveform with 12% duty
	SquareDuty14	Square waveform with 14% duty
	SquareDuty16	Square waveform with 16% duty
	SquareDuty18	Square waveform with 18% duty
	SquareDuty20	Square waveform with 20% duty
	SquareDuty22	Square waveform with 22% duty
	SquareDuty24	Square waveform with 24% duty
	SquareDuty26	Square waveform with 26% duty
	SquareDuty28	Square waveform with 28% duty
	SquareDuty30	Square waveform with 30% duty
	SquareDuty32	Square waveform with 32% duty
	SquareDuty34	Square waveform with 34% duty
	SquareDuty36	Square waveform with 36% duty
	SquareDuty38	Square waveform with 38% duty
	SquareDuty40	Square waveform with 40% duty
	SquareDuty42	Square waveform with 42% duty
	SquareDuty44	Square waveform with 44% duty
	SquareDuty46	Square waveform with 46% duty
SquareDuty48	Square waveform with 48% duty	
SquareDuty50	Square waveform with 50% duty	
SquareDuty52	Square waveform with 52% duty	
SquareDuty54	Square waveform with 54% duty	
SquareDuty56	Square waveform with 56% duty	
SquareDuty58	Square waveform with 58% duty	



	SquareDuty60	Square waveform with 60% duty
	SquareDuty62	Square waveform with 62% duty
	SquareDuty64	Square waveform with 64% duty
	SquareDuty66	Square waveform with 66% duty
	SquareDuty68	Square waveform with 68% duty
Square 2	SquareDuty70	Square waveform with 70% duty
	SquareDuty72	Square waveform with 72% duty
	SquareDuty74	Square waveform with 74% duty
	SquareDuty76	Square waveform with 76% duty
	SquareDuty78	Square waveform with 78% duty
	SquareDuty80	Square waveform with 80% duty
	SquareDuty82	Square waveform with 82% duty
	SquareDuty84	Square waveform with 84% duty
	SquareDuty86	Square waveform with 86% duty
	SquareDuty88	Square waveform with 88% duty
	SquareDuty90	Square waveform with 90% duty
	SquareDuty92	Square waveform with 92% duty
	SquareDuty94	Square waveform with 94% duty
	SquareDuty96	Square waveform with 96% duty
SquareDuty98	Square waveform with 98% duty	
SquareDuty99	Square waveform with 99% duty	
Medical	EOG	Electro-Oculogram
	EEG	Electroencephalogram
	EMG	Electromyogram
	Pulseilogram	Pulseilogram
	ResSpeed	Speed curve of the respiration
	ECG1	Electrocardiogram 1
	ECG2	Electrocardiogram 2
	ECG3	Electrocardiogram 3
	ECG4	Electrocardiogram 4
	ECG5	Electrocardiogram 5
	ECG6	Electrocardiogram 6
	ECG7	Electrocardiogram 7
ECG8	Electrocardiogram 8	

	ECG9	Electrocardiogram 9
	ECG10	Electrocardiogram 10
	ECG11	Electrocardiogram 11
	ECG12	Electrocardiogram 12
	ECG13	Electrocardiogram 13
	ECG14	Electrocardiogram 14
	ECG15	Electrocardiogram 15
	LFPulse	Waveform of the low frequency pulse electrotherapy
	Tens1	Waveform 1 of the nerve stimulation electrotherapy
	Tens2	Waveform 2 of the nerve stimulation electrotherapy
	Tens3	Waveform 3 of the nerve stimulation electrotherapy
Mod	AM	Sectional sine AM signal
	FM	Sectional sine FM signal
	PFM	Sectional pulse FM signal
	PM	Sectional sine PM signal I
	PWM	Sectional PWM signal
Filter	Butterworth	Butterworth filter
	Chebyshev1	Chebyshev1 filter
	Chebyshev2	Chebyshev2 filter
Demo	demo1_375pts	TureArb waveform 1 ( 375 pts )
	demo1_16kpts	TureArb waveform 1 ( 16384 pts )
	demo2_3kpts	TureArb waveform 2 ( 3000 pts )
	demo2_16kpts	TureArb waveform 2 ( 16384 pts )

## 2. To Select the Stored Waveform

Choose **Waveforms** → **Page 1/2** → **Arb** → **Arb Type** → **Stored Waveforms** to enter the following interface, as shown in Figure 2-22.

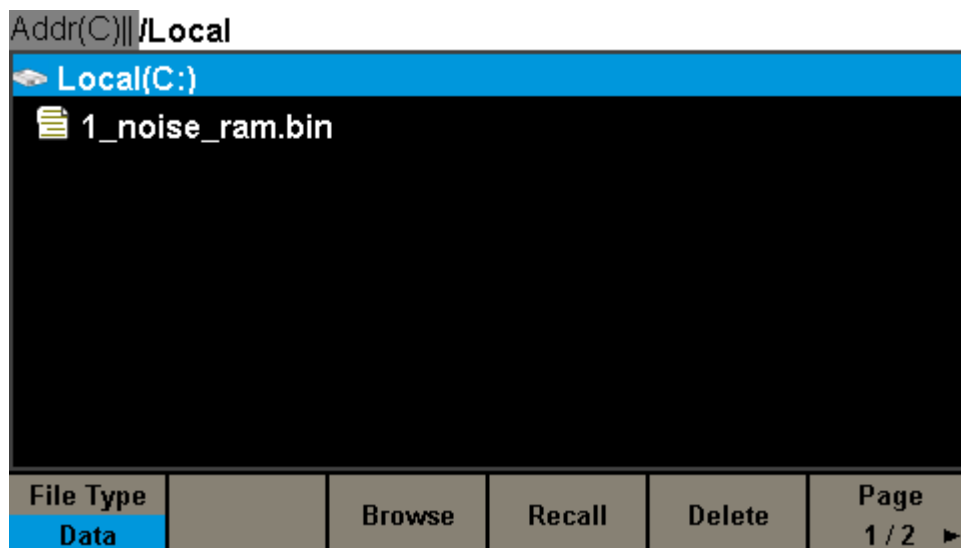

Figure 2-22 Stored Waveform Display Interface

Rotate the knob or touch the screen to choose the desired waveform. Then select **Recall** or press the knob to recall the corresponding waveform.

## 2.8 To Set Harmonic Function

The SDG2000X can be used as a harmonic generator to output harmonics with specified order, amplitude and phase. According to the Fourier transform, a periodic time domain waveform is the superposition of a series of sine waveforms as shown in the equation below:

$$f(t) = A_1 \sin(2\pi f_1 t + \varphi_1) + A_2 \sin(2\pi f_2 t + \varphi_2) + A_3 \sin(2\pi f_3 t + \varphi_3) + \dots$$

Generally, the component with  $f_1$  frequency is called fundamental waveform,  $f_1$  is fundamental waveform frequency,  $A_1$  is fundamental waveform amplitude, and  $\varphi_1$  is fundamental waveform phase. The frequencies of the other components (called harmonics) are all integral multiples of the fundamental waveform. Components whose frequencies are odd multiples of the fundamental waveform frequency are called odd harmonics and components whose frequencies are even multiples of the fundamental waveform frequency are called even harmonics.

Press **Waveforms** → **Sine** → **Harmonic** and choose “On”, then press **Harmonic Parameter** to enter the following interface.

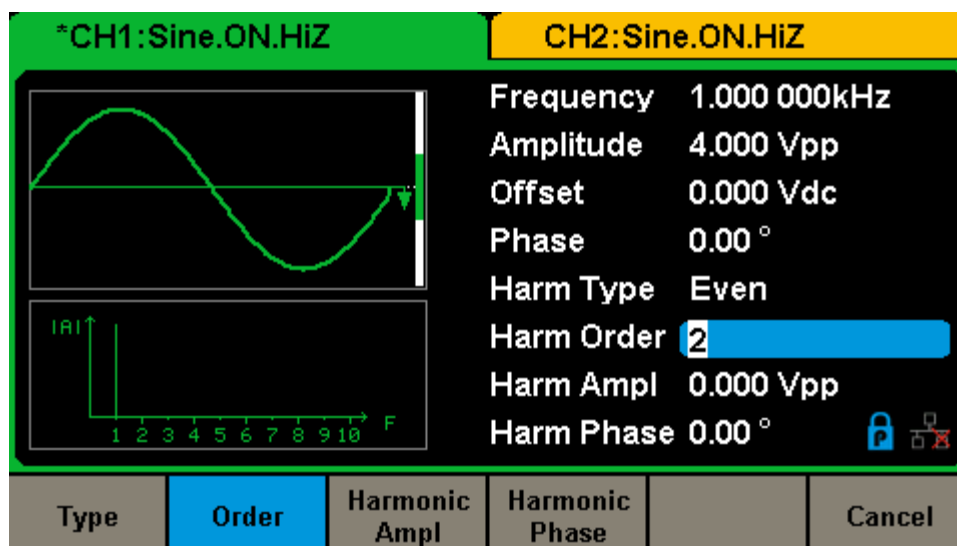

Figure 2-23 Harmonic Interface

Table 2-9 Menu Explanations of Harmonic

Function menu	Settings	Explanations
Type		Set the harmonic type to “odd”, “ever” or “all”.
Order		Set the order of the harmonic.
Harmonic Ampl		Set the amplitude of the harmonic.
Harmonic Phase		Set the phase of the harmonic.
Cancel		Return to the sine parameters menu.

### To Select the Harmonic Type

The SDG2000X can output odd harmonics, even harmonics and user-defined orders of harmonics. After entering the harmonic setting menu, press **Type** to select the desired harmonic type.

1. Press **Even**, the instrument will output fundamental waveform and even harmonics.
2. Press **Odd**, the instrument will output fundamental waveform and odd harmonics.
3. Press **All**, the instrument will output fundamental waveform and all the user-defined orders of harmonics.

### To Set the Harmonic Order

After entering the harmonic setting menu, press **Order**, then use the numeric keyboard or knob to input the desired value.

- The range is limited by the maximum output frequency of the instrument and current fundamental waveform frequency.
- Range: 2 to maximum output frequency of the instrument ÷ current fundamental waveform frequency
- The maximum is 10.

### To Select the Harmonic Amplitude

After entering the harmonic setting menu, press **Harmonic Ampl** to set the harmonic amplitude of each order.

1. Press **Order** to select the sequence number of the harmonic to be set.
2. Press **Harmonic Ampl** to set the amplitude of the harmonic selected. Use the arrow keys and knob to change the value. Or use the numeric keyboard to input the amplitude value and then select the desired unit from the pop-up menu. The units available are Vpp, mVpp and dBc.

### **To Select the Harmonic Phase**

After entering the harmonic setting menu, press **Harmonic Phase** to set the harmonic phase of each order.

1. Press **Order** to select the sequence number of the harmonic to be set.
2. Press **Harmonic Phase** to set the phase of the harmonic selected. Use the arrow keys and knob to change the value. Or use the numeric keyboard to input the phase value and then select the unit °.

---

## 2.9 To Set Modulation Function

Use the **Mod** key to generate modulated waveforms. The SDG2000X can generate AM, FM, ASK, FSK, PSK, PM, PWM and DSB-AM modulated waveforms. Modulating parameters vary with the types of the modulation. In AM, users can set the source (internal/external), depth, modulating frequency, modulating waveform and carrier. In DSB-AM, users can set the source (internal/external), modulating frequency, modulating waveform and carrier. In FM, users can set the source (internal/external), modulating frequency, frequency deviation, modulating waveform and carrier. In PM, users can set the source (internal/external), phase deviation, modulating frequency, modulating waveform and carrier. In ASK, users can set the source (internal/external), key frequency and carrier. In FSK, users can set the source (internal/external), key frequency, hop frequency and carrier. In PSK, users can set the source (internal/external), key frequency, polarity and carrier. In PWM, users can set the source (internal/external), modulating frequency, width/duty cycle deviation, modulating waveform and carrier.

We will introduce how to set these parameters in details according to the modulation types.

## 2.9.1 AM

The modulated waveform consists of two parts: the carrier and the modulating waveform. In AM, the amplitude of the carrier varies with the instantaneous voltage of the modulating waveform.

Press **Mod** → **Type** → **AM**, the parameters of AM modulation are shown in Figure 2-24.

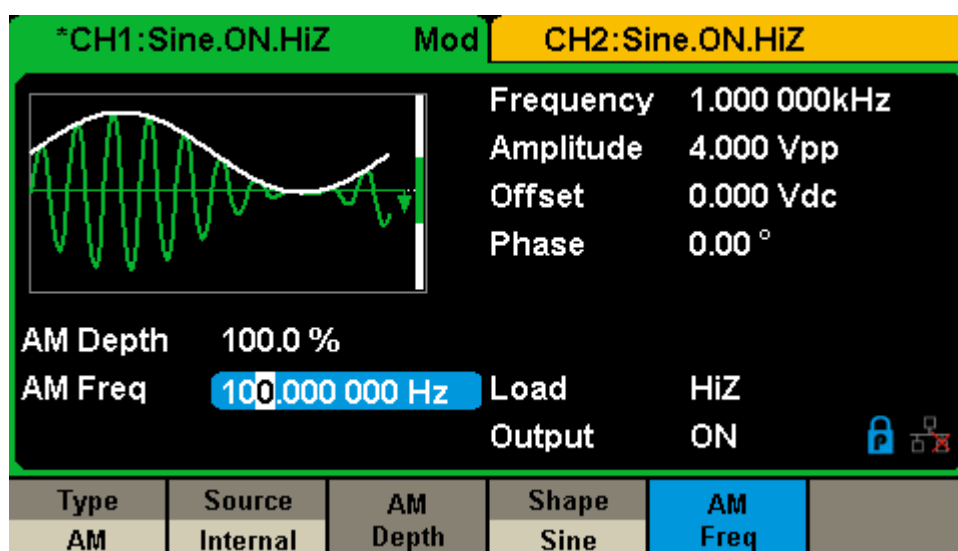

Figure 2-24 Setting Interface of AM Modulation

Table 2-10 Menu Explanations of the AM Parameters

Function Menu	Settings	Explanation
Type	AM	Amplitude modulation
Source	Internal	The source is internal
	External	The source is external. Use the [Aux In/Out] connector at the rear panel.
AM Depth		Set the modulation depth.
Shape	Sine	Choose the modulating waveform.
	Square	
	Triangle	
	UpRamp	
	DnRamp	



	Noise	
	Arb	
AM Freq		Set the modulating waveform frequency. Frequency range: 1mHz~1MHz (internal source only).

## To Select Modulation Source

The SDG2000X can accept modulating signal from an internal or external modulation source. Press **Mod** → **AM** → **Source** to select “Internal” or “External” modulation source. The default is “Internal”.

### 1. Internal Source

When internal AM modulation source is selected, press **Shape** to select Sine, Square, Triangle, UpRamp, DnRamp, Noise or Arb as modulating waveform.

- Square: 50% duty cycle
- Triangle: 50% symmetry
- UpRamp: 100% symmetry
- DnRamp: 0% symmetry
- Arb: the arbitrary waveform selected of the current channel

#### Note:

Noise can be used as modulating waveform but cannot be used as the carrier.

### 2. External Source

When external AM modulation source is selected, the generator accepts external modulating signal from the [Aux In/Out] connector at the rear panel. At this time, the amplitude of the modulated waveform is controlled by the signal level applied to the connector. For example, if the modulation depth is set to 100%, the output amplitude will be the maximum when the modulating signal is +6V and the minimum when the modulating signal is -6V.

#### Key Points:

The SDG2000X can use one channel as a modulating source for the other channel. The following example takes the output signal of CH2 as the modulating waveform.

1. Connect the CH2 output terminal to [Aux In/Out] connector on the rear panel using a dual BNC cable.
2. Select CH1 and press **Mod** to select the desired modulation type as well as set the corresponding parameters, and then select external modulation source.
3. Select CH2 and select the desired modulating waveform and set the corresponding parameters.
4. Press **Output** to enable the output of CH1.

### To Set Modulation Depth

Modulation depth expressed as a percentage indicates the amplitude variation degree. AM modulation depth varies from 1% to 120%. Press **AM Depth** to set the parameter.

- In the 0% modulation, the output amplitude is the half of the carrier's amplitude.
- In the 120% modulation, the output amplitude is the same with the carrier's amplitude.
- For an external source, the depth of AM is controlled by the voltage level on the connector connected to the [Aux In/Out].  $\pm 6V$  correspond to 100% depth.
- When external modulation source is selected, this menu is hidden.

### To Set Modulation Frequency

When internal modulation source is selected, press **AM Freq** to highlight the parameter, then use the numeric keyboard or arrow keys and knob to input the desired value.

- The modulation frequency ranges from 1mHz to 1MHz.
- When external modulation source is selected, this menu is hidden.

## 2.9.2 DSB-AM

DSB-AM is an abbreviation for Double-Sideband Suppressed Carrier – Amplitude Modulation. Press **Mod** → **Type** → **DSB-AM**. The parameters of DSB-AM modulation are shown in Figure 2-25.

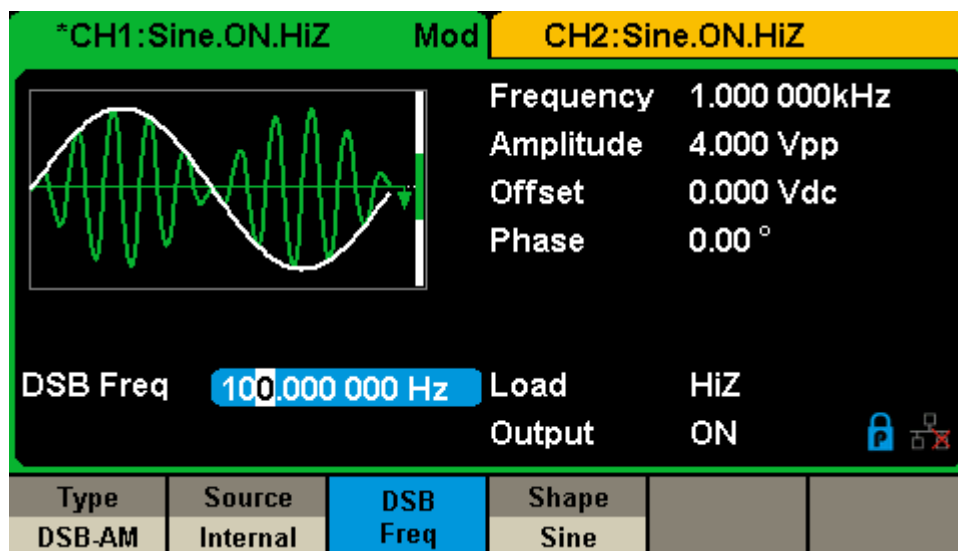

Figure 2-25 Setting Interface of DSB-AM Modulation

Table 2-11 Menu Explanations of the DSB-AM Parameters

Function Menu	Settings	Explanation
Type	DSB-AM	DSB Amplitude modulation.
Source	Internal	The source is internal.
	External	The source is external. Use the [Aux In/Out] connector at the rear panel.
DSB Freq		Set the modulating waveform frequency. Frequency range: 1mHz~1MHz (internal source only).
Shape	Sine	Choose the modulating waveform.
	Square	
	Triangle	
	UpRamp	
	DnRamp	
	Noise	
	Arb	

**Note:**

The methods of setting the parameters of DSB-AM are similar to AM.

### 2.9.3 FM

The modulated waveform consists of two parts: the carrier and the modulating waveform. In FM, the frequency of the carrier varies with the instantaneous voltage of the modulating waveform.

Press **Mod** → **Type** → **FM**, the parameters of FM modulation are shown in Figure 2-26

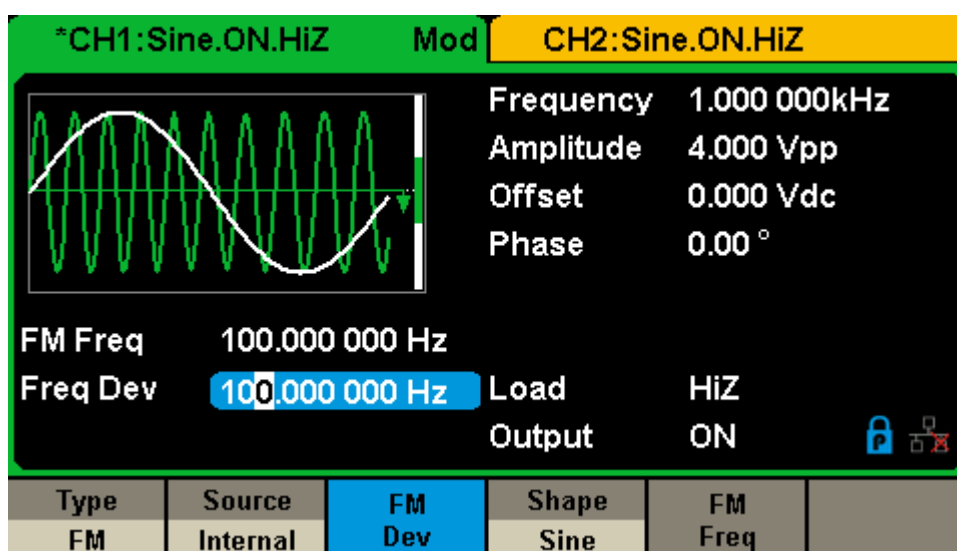

Figure 2-26 Setting Interface of FM Modulation

Table 2-12 Menu Explanations of the FM Parameters

Function Menu	Settings	Explanation
Type	FM	Frequency modulation
Source	Internal	The source is internal
	External	The source is external. Use the [Aux In/Out] connector at the rear panel.
Freq Dev		Set the frequency deviation
Shape	Sine	Choose the modulating waveform.
	Square	
	Triangle	
	UpRamp	
	DnRamp	

---

	Noise	
	Arb	
FM Freq		Set the modulating waveform frequency. Frequency range 1mHz~1MHz (internal source).

### To Set Frequency Deviation

Press **FM Dev** to highlight the parameter, and then use the numeric keyboard or arrow keys and knob to input the desired value.

- The deviation should be equal to or less than the carrier frequency.
- The sum of the deviation and the carrier frequency should be equal to or less than maximum frequency of the selected carrier waveform.

#### **Note:**

The methods of setting other parameters of FM are similar to AM.

## 2.9.4 PM

The modulated waveform consists of two parts: the carrier and the modulating waveform. In PM, the phase of the carrier varies with the instantaneous voltage level of the modulating waveform.

Press **Mod** → **Type** → **PM**, the parameters of PM modulation are shown in Figure 2-27.

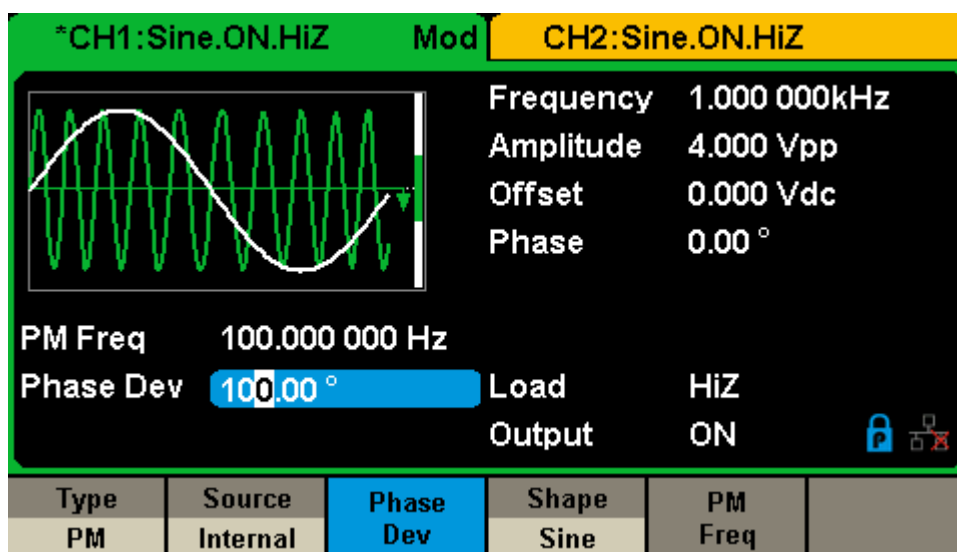

Figure 2-27 Setting Interface of PM Modulation

Table 2-13 Menu Explanations of the PM Parameters

Function Menu	Settings	Explanation
Type	PM	Phase modulation
Source	Internal	The source is internal
	External	The source is external. Use the [Aux In/Out] connector at the rear panel.
Phase Dev		Phase deviation ranges from 0° ~ 360°.
Shape	Sine	Choose the modulating waveform.
	Square	
	Triangle	
	UpRamp	
	DnRamp	

---

	Noise	
	Arb	
PM Freq		Set the modulating waveform frequency. Frequency range: 1mHz~1MHz.

### To Set Phase Deviation

Press **Phase Dev** to highlight the parameter, and then use the numeric keyboard or arrow keys and knob to input the desired value.

- Use the numeric keyboard or arrow keys and knob to input the desired value.
- The range of phase deviation is from 0° to 360° and the default value is 100°.

#### Note:

The methods of setting other parameters of PM are similar to AM.



## 2.9.5 FSK

The FSK is Frequency Shift Keying, the output frequency of which switches between two preset frequencies (carrier frequency and the hop frequency or sometimes known as mark frequency (1) and space frequency (0)).

Press **Mod** → **Type** → **FSK**, the parameters of FSK modulation are shown in Figure 2-28.

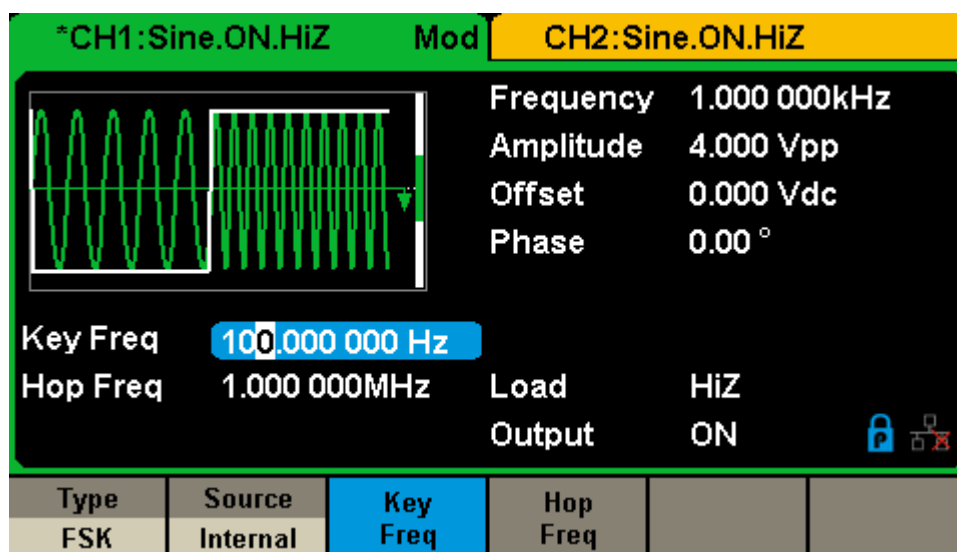

Figure 2-28 Setting Interface of FSK Modulation

Table 2-14 Menu Explanations of the FSK Parameters

Function Menu	Settings	Explanation
Type	FSK	Frequency shift keying modulation.
Source	Internal	The source is internal.
	External	The source is external. Use the [Aux In/Out] connector at the rear panel.
Key Freq		Set the frequency at which the output frequency shifts between the carrier frequency and the hop frequency (internal modulation only): 1mHz~1MHz.
Hop Freq		Set the hop frequency.

### To Set Key Frequency

When internal modulation source is selected, press **Key Freq** to set the rate at which the output frequency shifts between “carrier frequency” and “hop

---

frequency”.

- Use the numeric keyboard or arrow keys and knob to input the desired value.
- The key frequency ranges from 1mHz to 1MHz.
- When external modulation source is selected, this menu is hidden.

### To Set Hop Frequency

The range of the hop frequency depends on the carrier frequency currently selected. Press **Hop Freq** to highlight the parameter, and then use the numeric keyboard or arrow keys and knob to input the desired value.

- Sine: 1uHz~120MHz
- Square: 1uHz~25MHz
- Ramp: 1uHz~1MHz
- Arb: 1uHz~20MHz

### Note:

The methods of setting other parameters of FSK are similar to AM. In addition, the external modulating signal of FSK must be Square which complies with the CMOS level specification.

## 2.9.6 ASK

When using ASK (Amplitude Shift Keying), the carrier frequency and key frequency will need to be set. The key frequency is the shift rate of modulated waveform amplitude.

Press **Mod** → **Type** → **ASK**, the parameters of ASK modulation are shown in Figure 2-29.

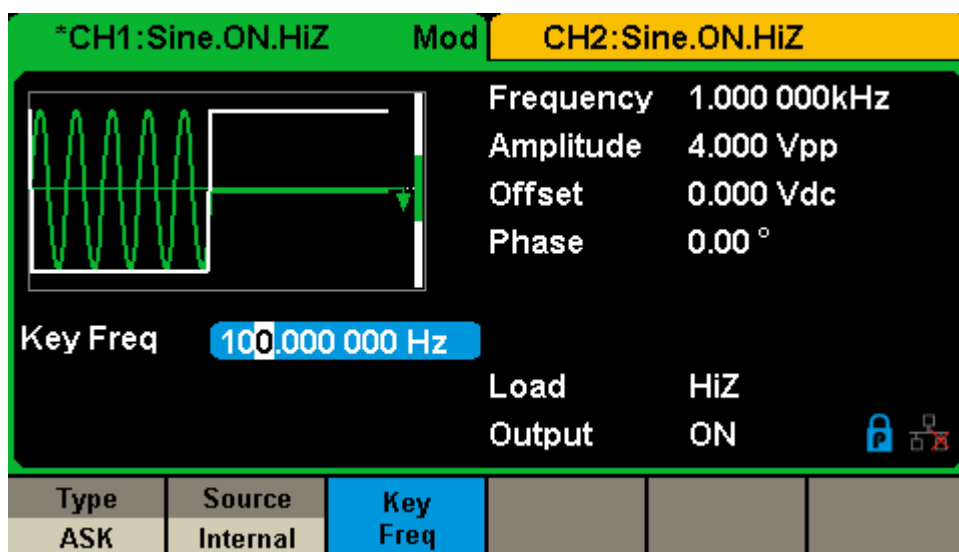

Figure 2-29 Setting Interface of ASK Modulation

Table 2-15 Menu Explanations of the ASK Parameters

Function Menu	Settings	Explanation
Type	ASK	Amplitude shift keying modulation.
Source	Internal	The source is internal.
	External	The source is external. Use the [Aux In/Out] connector at the rear panel.
Key Freq		Set the frequency at which the output amplitude shifts between the carrier amplitude and zero (internal modulation only): 1mHz~1MHz.

**Note:**

The methods for setting the parameters of ASK are similar to AM. In addition, the external modulating signal of ASK must be Square which complies with the CMOS level specification.

## 2.9.7 PSK

When using PSK (Phase Shift Keying), configure the generator to “shift” its output phase between two preset phase values (carrier phase and modulating phase). The default modulating phase is 180°.

Press **Mod** → **Type** → **PSK**, the parameters of PSK modulation are shown in Figure 2-30.

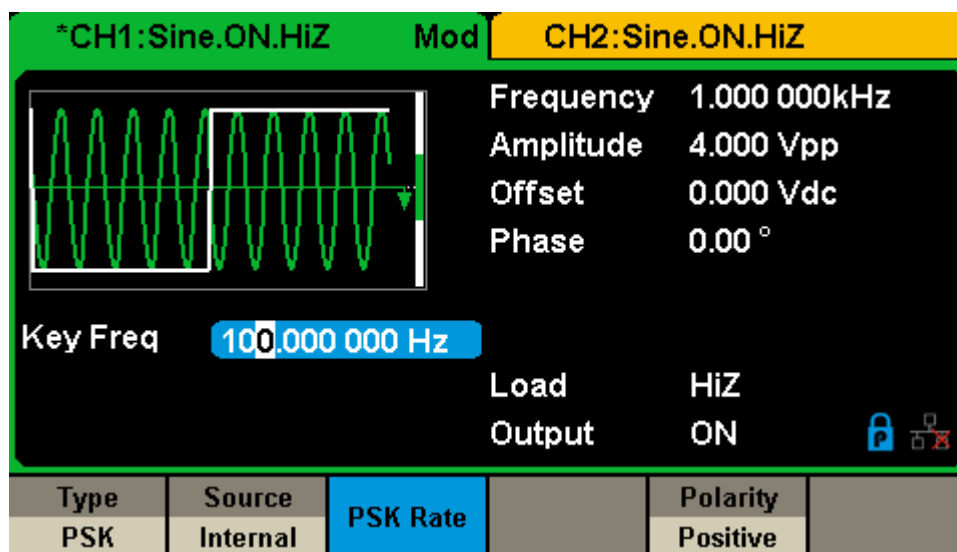

Figure 2-30 Setting Interface of PSK Modulation

Table 2-16 Menu Explanations of the PSK Parameters

Function Menu	Settings	Explanation
Type	PSK	Phase shift keying modulation.
Source	Internal	The source is internal.
	External	The source is external. Use the [Aux In/Out] connector at the rear panel.
Key Freq		Set the frequency at which the output phase shifts between the carrier phase and 180° (internal modulation only): 1mHz~1MHz.
Polarity	Positive	Set the modulating polarity.
	Negative	

**Note:**

The methods of setting the parameters of PSK are similar to AM. In addition, the external modulating signal of PSK must be Square which complies with the CMOS level specification.

## 2.9.8 PWM

In PWM (Pulse Width Modulation), the pulse width of the pulse varies with the instantaneous voltage of the modulating waveform. The carrier can only be pulse.

Press **Waveforms** → **Pulse** → **Mod**, the parameters of PWM modulation are shown in Figure 2-31

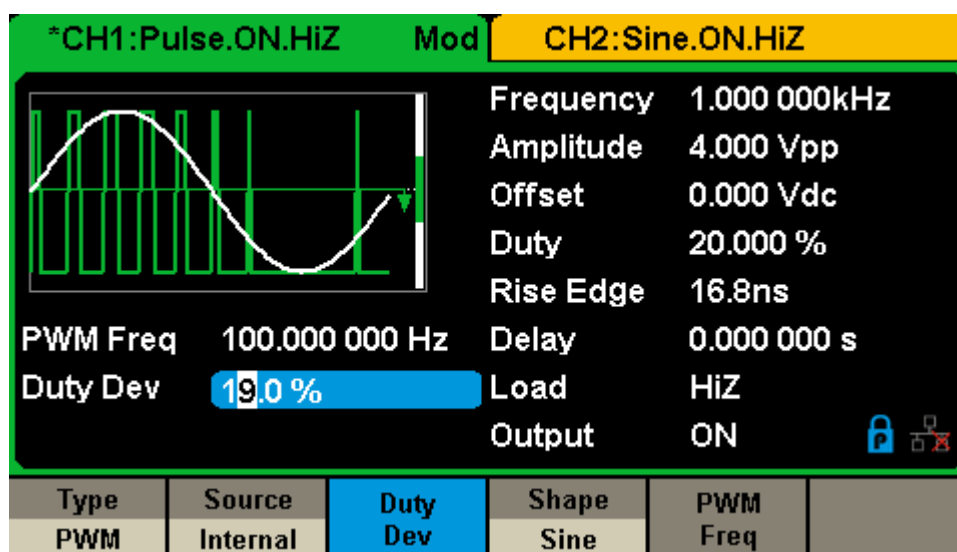

Figure 2-31 Setting Interface of PWM Modulation

Table 2-17 Menu Explanations of the PWM Parameters

Function Menu	Settings	Explanation
Type	PWM	Pulse width modulation. The carrier is pulse.
Source	Internal	The source is internal.
	External	The source is external. Use the [Aux In/Out] connector at the rear panel.
Width Dev		Set the width deviation.
Duty Dev		Set the duty deviation.
Shape	Sine	Choose the modulating waveform.
	Square	
	Triangle	
	UpRamp	
	DnRamp	

	Noise	
	Arb	
PWM Freq		Set the modulating waveform frequency. Frequency range: 1mHz~1MHz (internal source only).

### To Set Pulse Width/Duty Deviation

Width Deviation represents the variation of the modulated waveform pulse width relative to the original pulse width. Press **Width Dev** to highlight the parameter, and use the numeric keyboard or arrow keys and knob to input the desired value, as shown in the Figure 2-32.

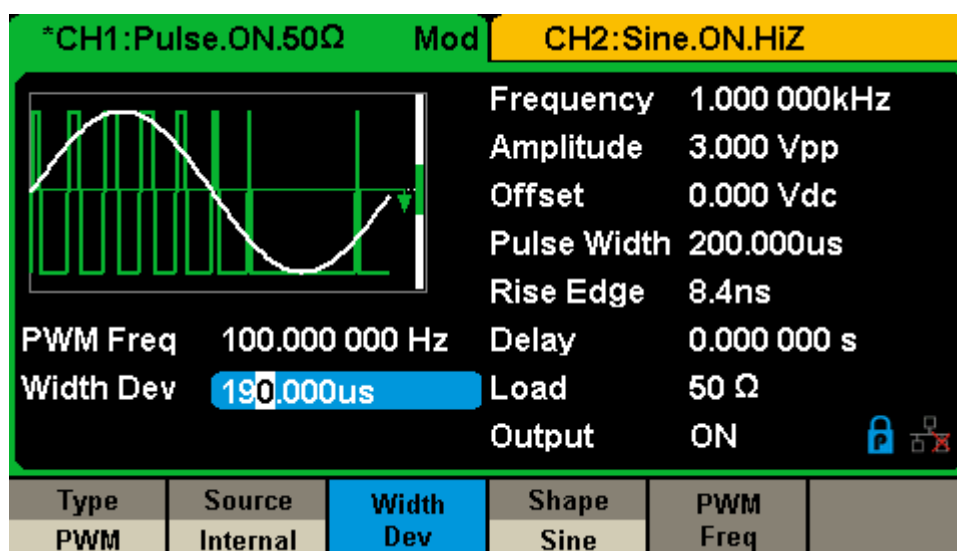

Figure 2-32 Width Deviation Setting Interface

- The width deviation cannot exceed the current pulse width.
- The width deviation is limited by the minimum pulse width and current edge time setting.

Duty Deviation represents the variation (%) of the modulated waveform duty relative to the original duty. Press **Duty Dev** to highlight the parameter, and then use the numeric keyboard or arrow keys and knob to input the desired value, as shown in the Figure 2-33.



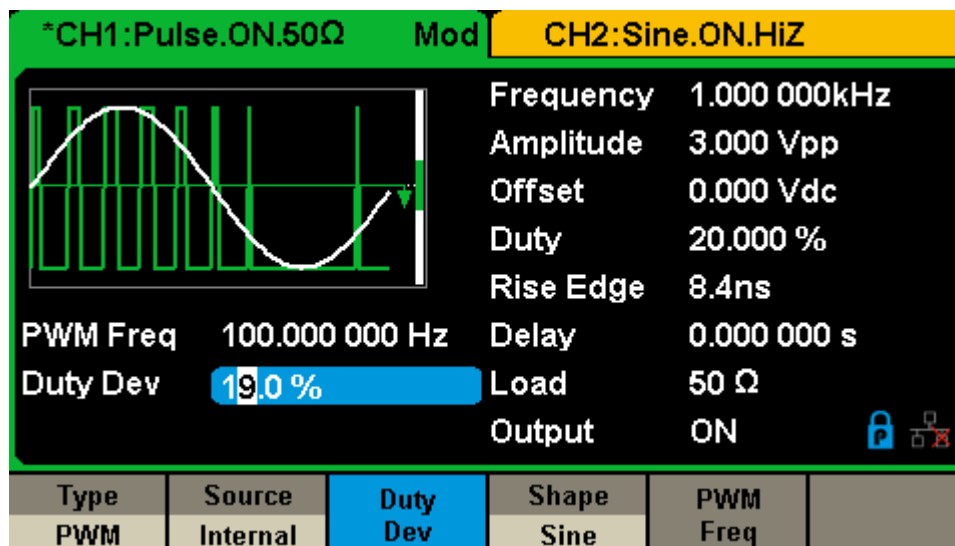

Figure 2-33 Duty Deviation Setting Interface

- The duty deviation cannot exceed the current pulse duty cycle.
- The duty deviation is limited by the minimum duty cycle and current edge time setting.
- Duty deviation and width deviation are correlative. Once a parameter is changed, the other will be automatically changed.

**Note:**

The methods of setting other parameters of PWM are similar to AM.

## 2.10 To Set Sweep Function

In the sweep mode, the generator steps from the start frequency to the stop frequency in the sweep time specified by the user. The waveforms that support sweep include sine, square, ramp and arbitrary.

Press **Sweep** key to enter the following menu. Set the waveform parameters by using the operation menu.

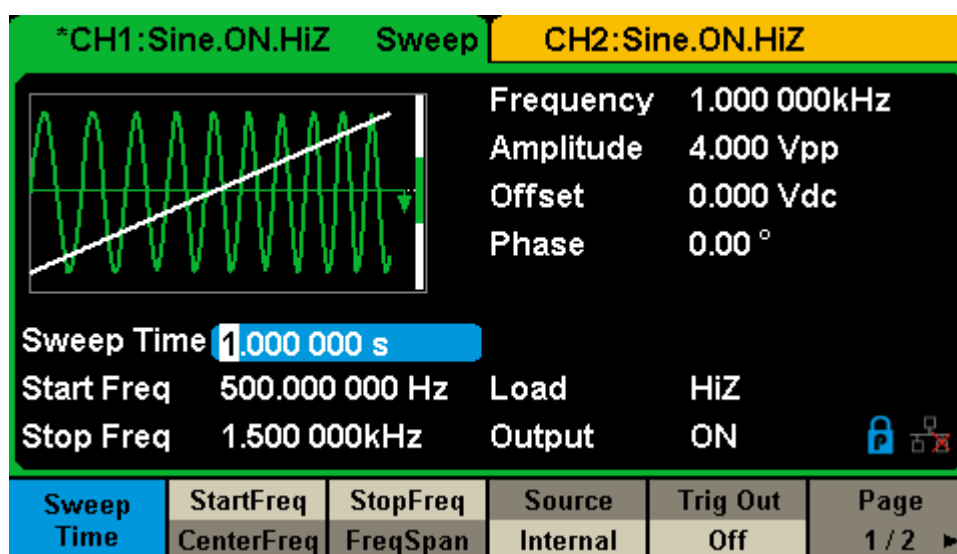

Figure 2-34 Setting Interface of Sweep (Page 1/2)

Table 2-18 Menu Explanations of Sweep (Page 1/2)

Function Menu	Settings	Explanation
Sweep time		Set the time span of the sweep in which the frequency changes from the start frequency to stop frequency.
Start Freq Mid Freq		Set the start frequency of the sweep; Set the center frequency of the sweep.
Stop Freq Freq Span		Set the stop frequency of the sweep; Set the frequency span of the sweep.
Source	Internal	Choose internal source as a trigger.
	External	Choose external source as a trigger. Use the [Aux In/Out] connector at the rear panel.
	Manual	Trigger a sweep by manual.
Trig Out	Off	Disable trigger out.
	On	Enable trigger out.

Page 1/2	Enter the next page.
-------------	----------------------

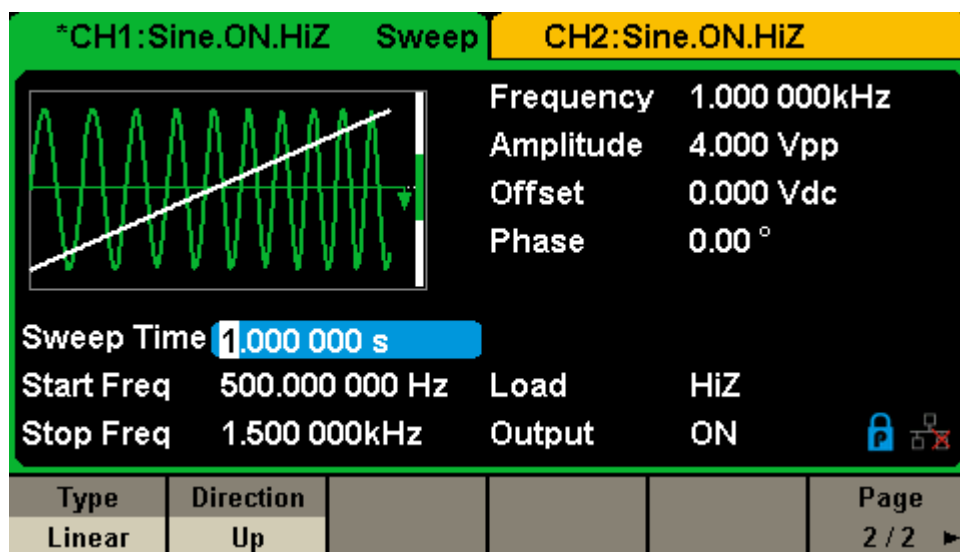

Figure 2-35 Setting Interface of Sweep (Page 2/2)

Table 2-19 Menu Explanations of Sweep (Page 2/2)

Function Menu	Settings	Explanation
Type	Linear	Set the sweep with linear profile.
	Log	Set the sweep with logarithmic profile.
Direction	Up	Sweep upward.
	Down	Sweep downward.
Page 2/2		Return to the previous page.

### Sweep Frequency

Use start freq and stop freq or center freq and freq span to set the range of the frequency sweep. Press the key again to switch between the two sweep range modes.

### Start Frequency and Stop Frequency

Start Frequency and Stop Frequency are the lower and upper limits of the

frequency for sweep. Start Frequency ≤ Stop Frequency.

- Choose **Direction** → **Up**, the generator will sweep from Start frequency to Stop frequency.
- Choose **Direction** → **Down**, the generator will sweep from Stop frequency to Start frequency.

### Center Frequency and Frequency Span

Center Frequency = (|Start Frequency + Stop Frequency|)/2

Frequency Span = Stop Frequency – Start Frequency

### Sweep Type

SDG2000X provides “Linear” and “Log” sweep profiles and the default is “Linear”.

### Linear Sweep

In linear sweep, the output frequency of the instrument varies linearly in the way of “a number of Hertz per second”. Choose **Sweep** → **Page 1/2** → **Type** → **Linear**, there is a straight line displayed on the waveform on the screen, indicating that the output frequency varies linearly.

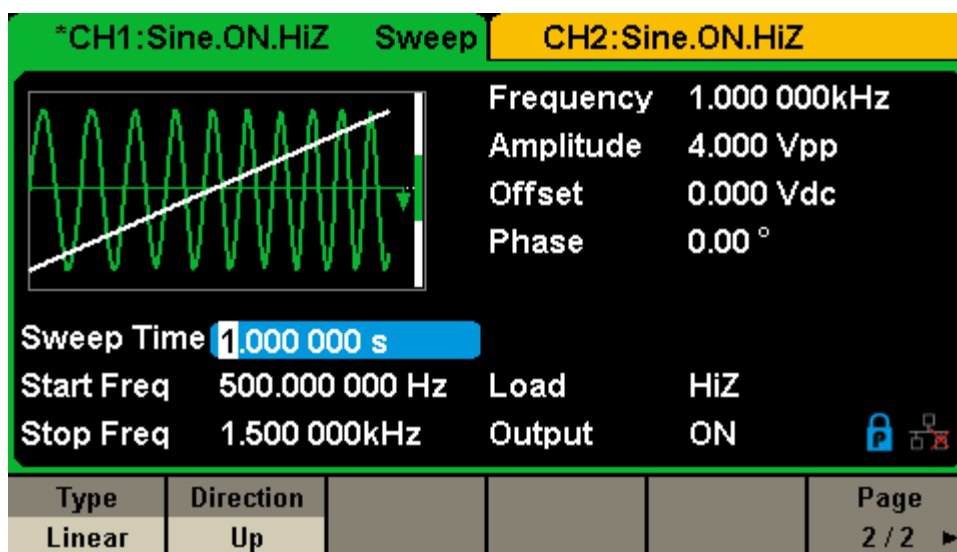

Figure 2-36 Linear Sweep Interface

## Log Sweep

In log sweep, the output frequency of the instrument varies in a logarithmic fashion, that is, the output frequency changes in the way of “decade per second”. Choose **Sweep** → **Page 1/2** → **Type** → **Log**, there is an exponential function curve displayed on the waveform on the screen, indicating that the output frequency changes in a logarithmic mode.

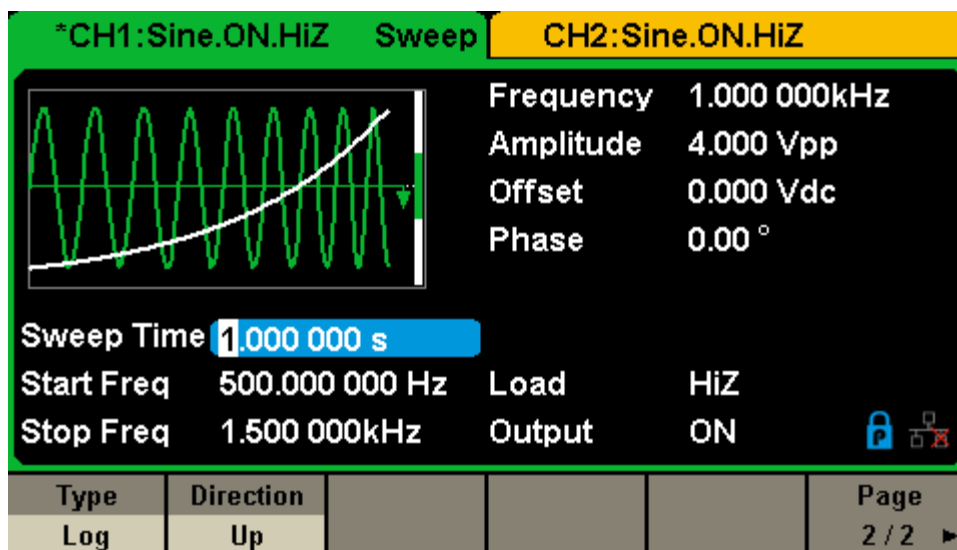

Figure 2-37 Log Sweep Interface

## Sweep Trigger Source

The sweep trigger source can be internal, external or manual. The generator will generate a sweep output when a trigger signal is received and then wait for the next trigger source.

### 1. Internal Trigger

Choose **Source** → **Internal**, the generator outputs continuous sweep waveform when internal trigger is selected. The default is “Internal”. Choose **Trig Out** → **On**, the [Aux In/Out] connector at the rear panel will output the trigger signal.

### 2. External Trigger

Choose **Source** → **External**, the generator accepts the trigger signal inputted from the [Aux In/Out] connector at the rear panel when external trigger is selected. A sweep will be generated once the connector receives a CMOS pulse with specified polarity. To set the CMOS pulse polarity, choose **Edge** to select “Up” or “Down”.

### **3. Manual Trigger**

Choose **Source** → **Manual**, a sweep will be generated from the corresponding channel when the **Trigger** softkey is pressed when manual trigger is selected. Choose **Trig Out** → **On**, the [Aux In/Out] connector at the rear panel will output the trigger signal.

## 2.11 To Set Burst Function

The Burst function can generate versatile waveforms in n this mode. Burst times can last a specific number of waveform cycles (N-Cycle mode), or when an external gated signals (Gated mode) is applied. Any waveform (except DC) may be used as the carrier, but noise can only be used in Gated mode.

### Burst Type

SDG2000X provides three burst types including N-Cycle, Infinite and Gated. The default is N-Cycle.

Table 2-20 Relations among burst type, trigger source and carrier

Burst Type	Trigger Source	Carrier
N-Cycle	Internal/External/Manual	Sine, Square, Ramp, Pulse, Arbitrary.
Infinite	External/Manual	Sine, Square, Ramp, Pulse, Arbitrary.
Gated	Internal/External	Sine, Square, Ramp, Pulse, Noise, Arbitrary.

### N-Cycle

In N-Cycle mode, the generator will output waveform with a specified number of cycles after receiving the trigger signal. Waveforms that support N-Cycle burst include sine, square, ramp, pulse and arbitrary.

Press **Burst** → **NCycle** → **Cycles**, and use the numeric keyboard or arrow keys and knob to input the desired cycles. Set the waveform parameters by using the operation menu, as shown in Figure 2-38 and Figure 2-39.

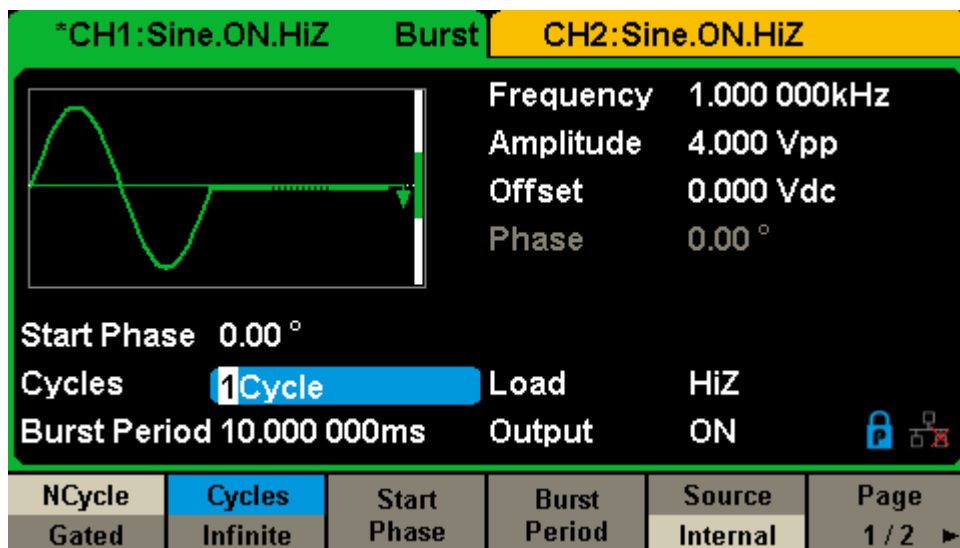

Figure 2-38 N-Cycle Burst Interface (Page 1/2)

Table 2-21 Menu Explanations of the N-Cycle Burst (Page 1/2)

Function Menu	Settings	Explanation
NCycle		Use the N-Cycle mode.
Cycles Infinite		Set the number of the bursts in N-Cycle. Set the number of the bursts in N-Cycle to be infinite.
Start Phase		Set the start phase of the burst.
Burst Period		Set the burst period.
Source	Internal	Choose internal source as a trigger.
	External	Choose external source as a trigger. Use the [Aux In/Out] connector at the rear panel.
	Manual	Trigger a burst by manual.
Page 1/2		Enter the next page.



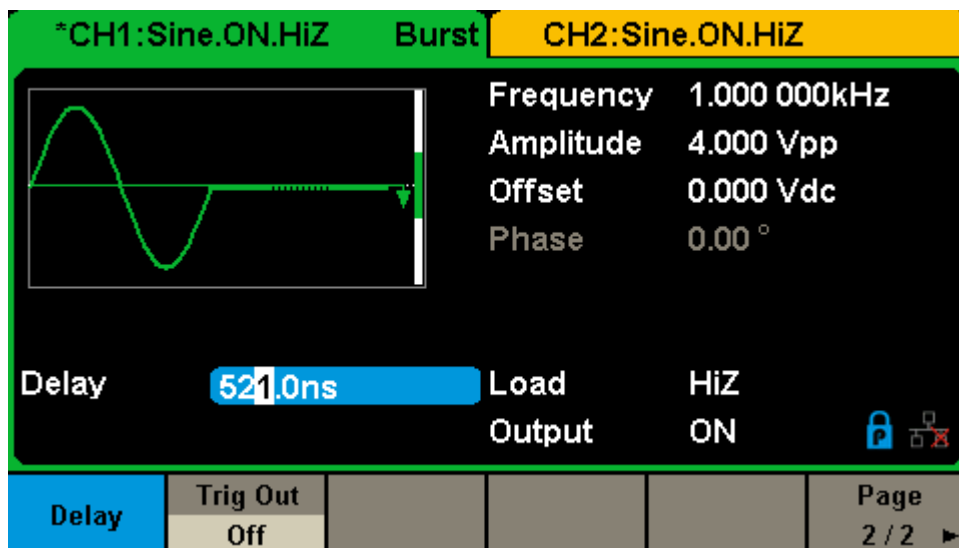

Figure 2-39 N-Cycle Burst Interface (Page 2/2)

Table 2-22 Menu Explanations of the N-Cycle Burst (Page2/2)

Function Menu	Settings	Explanation
Delay		Set the delay time before the burst starts.
Trig Out	Off	Disable trigger out.
	On	Enable trigger out.
Page 2/2		Return to the previous page.

## Infinite

In infinite mode, the cycle number of the waveform is set as an infinite value. The generator outputs a continuous waveform after receiving the trigger signal. Waveforms that support infinite mode include sine, square, ramp, pulse and arbitrary.

Press **Burst** → **NCycle** → **Infinite**, and set the trigger source to “external” or “manual”. The screen will display an infinite cycle burst, as shown in Figure 2-40 Infinite Burst InterfaceFigure 2-40.

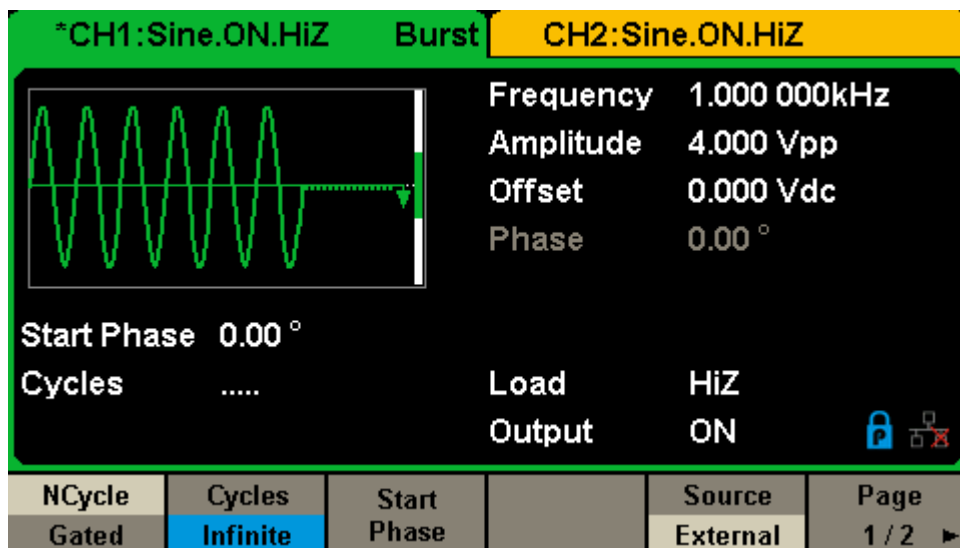

Figure 2-40 Infinite Burst Interface

### Gated

In gated mode, the generator controls the waveform output according to the gate signal level. When the gated signal is “true”, the generator outputs a continuous waveform. When the gated signal is “false”, the generator first completes the output of the current period and then stops. Waveforms that support gated burst include sine, square, ramp, pulse, noise and arbitrary.

Press **Burst** → **Gated**, to enter the following interface.

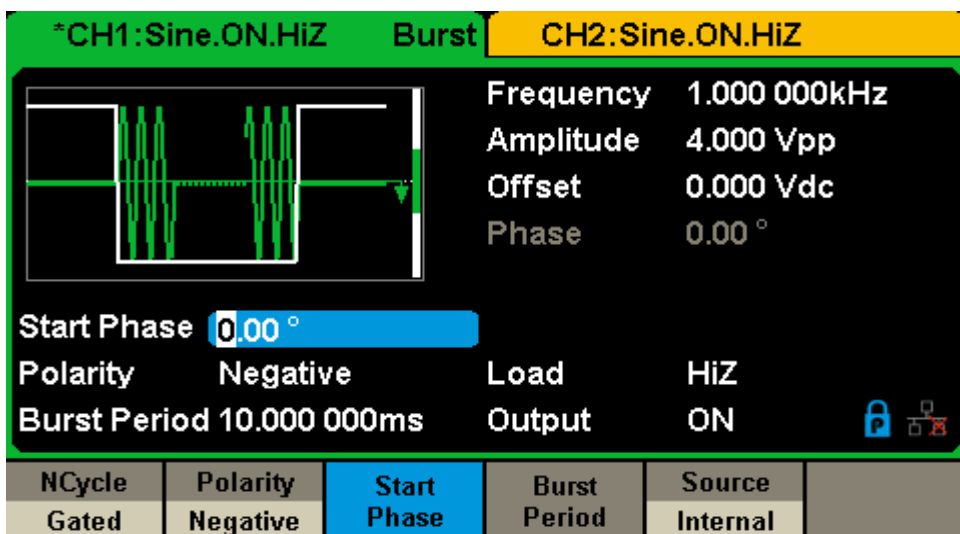

Figure 2-41 Gated Burst Interface

Table 2-23 Menu Explanations of the Gated Burst

Function Menu	Settings	Explanation
Gated		Use the gated mode.
Polarity	Positive	Set the polarity for the gated signal.
	Negative	
Start Phase		Set the start phase of the burst.
Burst Period		Set the burst Period.
Source	Internal	Choose internal source as a trigger.
	External	Choose external source as a trigger. Use the [Aux In/Out] connector at the rear panel.

### Start Phase

Define the start point in a waveform. The phase varies from 0° to 360°, and the default setting is 0°. For an Arbitrary Waveform, 0° is the first waveform point.

### Burst Period

Burst Period is only available when the trigger source is internal. It is defined as the time from the start of a burst to the start of the next one. Choose **Burst Period** and use the numeric keyboard or arrow keys and knob to input the desired value.

- Burst Period  $\geq 0.99\mu\text{s} + \text{carrier period} \times \text{burst number}$
- If the current burst period set is too short, the generator will increase this value automatically to allow outputting the specified number of cycles.

### Cycles/Infinite

Set the number of waveform cycle in an N-Cycle (1 to 50,000 or Infinite).

If Infinite is chosen, then a continuous waveform will be generated once a

---

trigger occurs.

### **Delay**

Set the time delay between the trigger input and the start of the N-Cycle burst.

### **Burst Trigger Source**

The burst trigger source can be internal, external or manual. The generator will generate a burst output when a trigger signal is received and then wait for the next trigger source.

#### **1. Internal Trigger**

Choose **Source** → **Internal**, the generator outputs continuous burst waveform when internal trigger is selected. Choose **Trig Out** as “Up” or “Down”, the [Aux In/Out] connector at the rear panel will output a trigger signal with specified edge.

#### **2. External Trigger**

Choose **Source** → **External**, the generator accepts the trigger signal inputted from the [Aux In/Out] connector at the rear panel when external trigger is selected. A burst will be generated once the connector gets a CMOS pulse with specified polarity. To set the CMOS pulse polarity, choose **Edge** to select “Up” or “Down”.

#### **3. Manual Trigger**

Choose **Source** → **Manual**, a burst will be generated from the corresponding channel when the **Trigger** softkey is pressed when manual trigger is selected.

## 2.12 To Store and Recall

SDG2000X can store the current instrument state and user-defined arbitrary waveform data in internal or external memory and recall them when needed.

Press **Store/Recall** to enter the following interface.

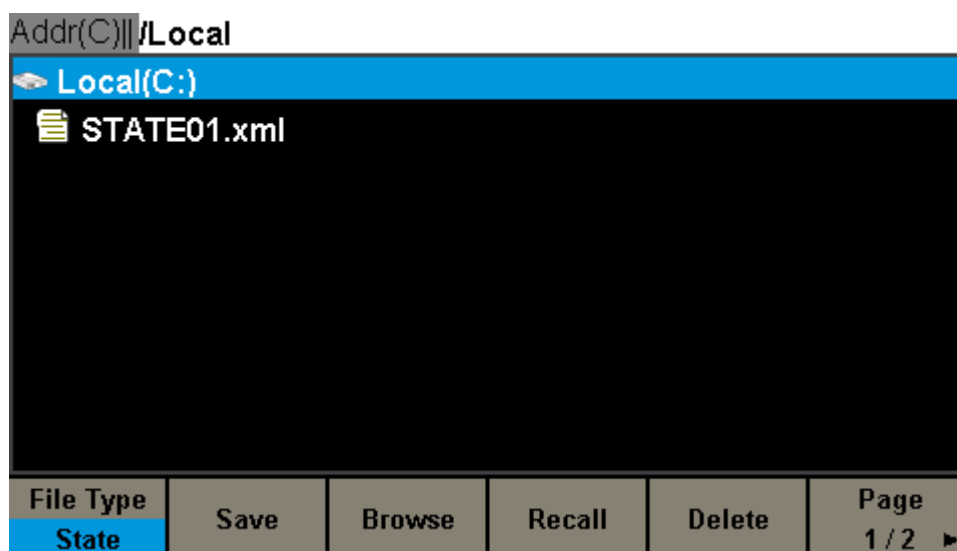

Figure 2-42 Store/Recall Interface (Page 1/2)

Table 2-24 Menu Explanations of Save and Recall

Function Menu	Settings	Explanation
File Type	State	The setting of the generator;
	Data	Arbitrary waveform file
Browse		View the current directory.
Save		Save the waveform to the specified path.
Recall		Recall the waveform or setting information in the specific position of the memory.
Delete		Delete the selected file.
Page 1/2		Enter the next page.

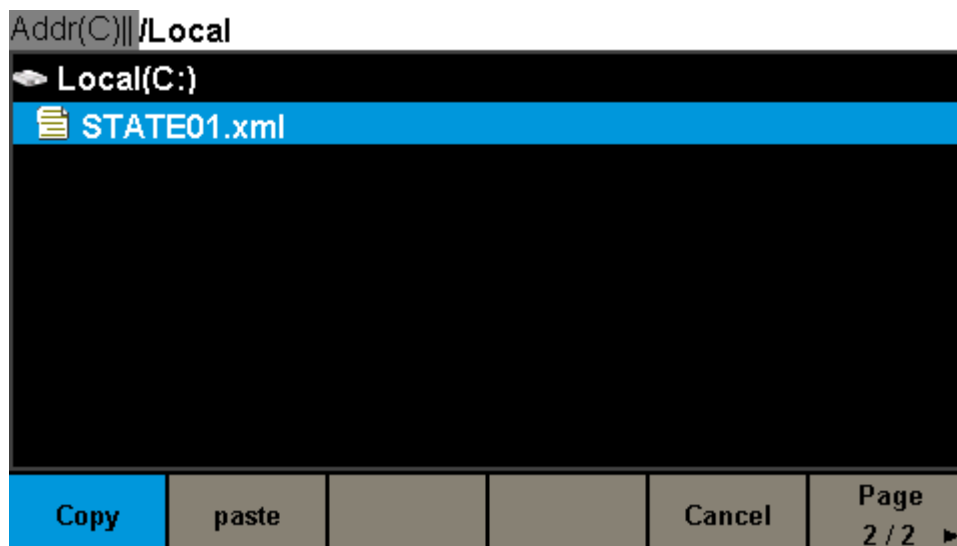

Figure 2-43 Store/Recall Interface (Page 2/2)

Table 2-25 Menu Explanations of Save and Recall

Function Menu	Settings	Explanation
Copy		Copy the selected file.
Paste		Paste the selected file.
Cancel		Exit the Store/Recall interface.
Page 2/2		Return to the previous page.

## 2.12.1 Storage System

The SDG2000X provides an internal non-volatile memory (C Disk) and a USB Host interface for external memory.

### 1. Local (C:)

Users can store instrument states and arbitrary waveform files to C Disk.

### 2. USB Device (0:)

There is a USB Host interface located on the left side of the front panel which permits users to store/recall waveforms or update the firmware version by U-Disk. When the generator detects a USB storage device, the screen will

show the drive letter “USB Device (0:)” and display a prompt message “USB device connected.”, as shown in Figure 2-44. After removing the U-Disk, the screen will display a prompt message “USB device removed.” And “USB Device (0:)” in the storage menu will disappear.

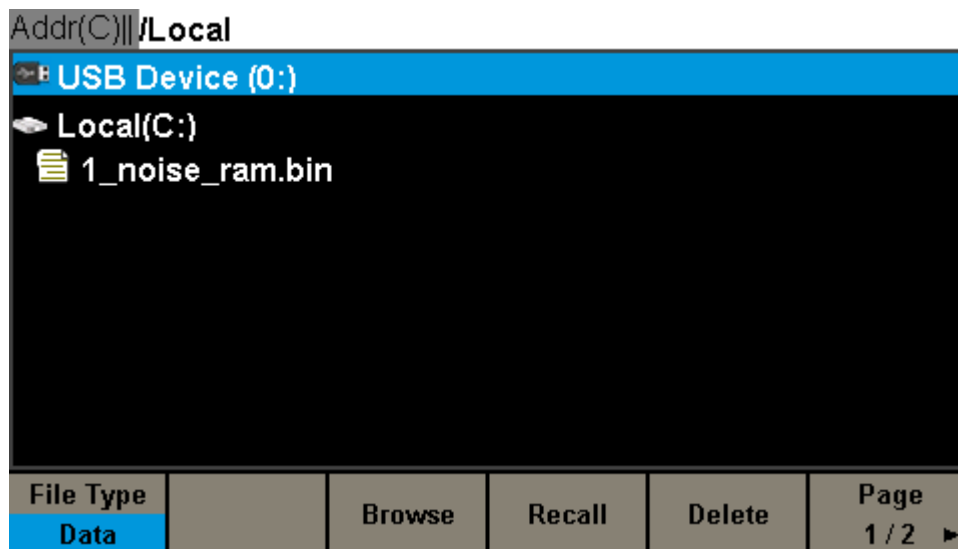

Figure 2-44 Storage System

#### Note:

The SDG2000X can only identify files of which filenames consist of English letters, number and underscore. If other characters are used, the name may be displayed in the store and recall interface abnormally.

## Browse

- Use the knob to shift between the directories or click the corresponding location on the screen to choose Local (C:) or USB Device (0:). Choose **Browse**, press the knob or click the selected folder to open the current directory.
- Use the knob to switch between folder and files under the current directory. Choose **Browse**, press the knob or click the selected folder to open the subdirectory. Choose **<up>**, then choose **Brower** or press the knob to return to the upper level directory.

---

## 2.12.2 File Type

Choose **Store/Recall** → **File Type** to select the desired file type. Available file types are State File and Data File.

### State File

Store the instrument state in internal or external memory in “\*.xml” format. The state file stored includes waveform parameters and modulation, sweep, burst parameters of two channels and utility parameters.

### Data File

The SDG2000X can recall the data files in “\*.csv” or “\*.dat” format from the external memory and transfer them into “\*.bin” format then store them in the internal memory. When it is done, the generator will enter the arbitrary waveform interface automatically.

In addition, users can edit arbitrary waveforms with PC software — EasyWave, download them to the internal memory through remote interface and store them (in “\*.bin” format) in the internal memory.



## 2.12.3 File Operation

### To Save the Instrument State

Users can store the current instrument state in internal and external memories. The storage will save the selected function (including the basic waveform parameters, modulation parameters and other utility settings used.)

To save the instrument state, the procedures are given as followed:

#### 1. Choose the file type to store.

Press **Store/Recall** → **File Type** → **State**, and choose state as the storage type.

#### 2. Choose the location of the file.

Choose a desired location by rotating the knob or clicking the corresponding location on the touch screen.

#### 3. Name the file.

Press **Save**, to enter the following interface.

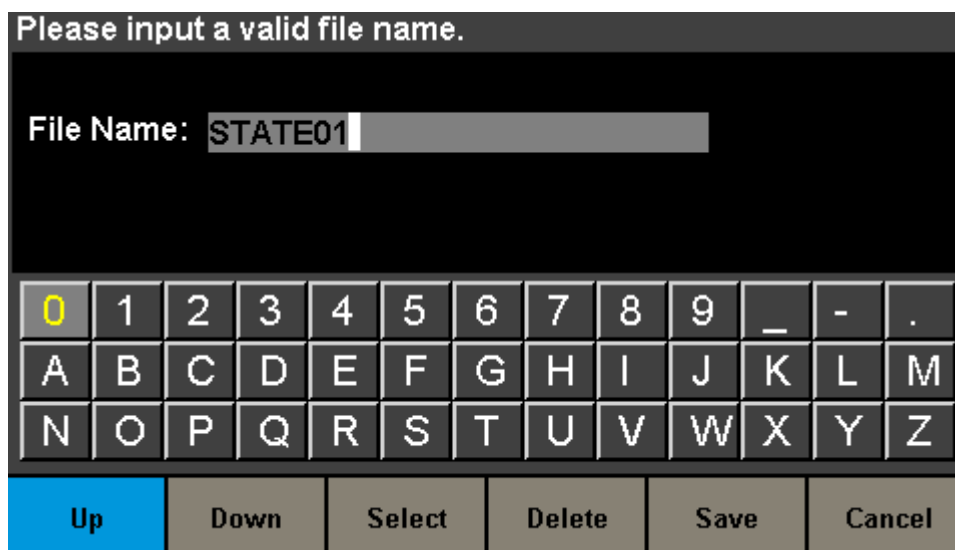

Figure 2-45 Filename Input Interface

Table 2-26 Menu Explanation of File Storage

Function Menu	Settings	Explanation
Up		Cursor upward to select.
Down		Cursor downward to select.
Select		Select the current character.
Delete		Delete the current character.
Save		Store the file with the current name.
Cancel		Return to the store/Recall interface.

### Select the character

Users can select the desired character from the virtual soft keyboard by using the knob or **Up** and **Down** menus. Or touch the location of the character on the screen directly. Then choose **Select** to display the character selected in the filename area.

### Delete the character

Use the left and right arrow keys to move the cursor in the file name. Then choose **Delete** to delete the corresponding character.

### 4. Save the file.

After finishing inputting filename, press **Save**. The generator will save the file under the currently selected directory with the specified filename.

## To Recall State File or Data File

To recall the instrument state or arbitrary waveform data, the procedures are as follows:

### 1. Choose the file type.

---

Press **Store/Recall** → **File Type**, and choose state or data as the storage type.

## 2. Choose the file to be recalled.

Rotate the knob or click the touch screen to select the file you want to recall.

## 3. Recall the file.

Choose **Recall**, press the knob or click the location of the file on the screen, the generator will recall the selected file and display corresponding prompt message when the file is read successfully.

## To Delete File

To delete the instrument state or arbitrary waveform data, the procedures are as follows:

### 1. Choose the file.

Rotate the knob or click the touch screen to select the file you want to delete.

### 2. Delete the file.

Choose **Delete**, the generator will display prompt message 'Delete the file?' Then press **Accept**, the generator will delete the currently selected file.

## To Copy and Paste File

SDG2000X supports the internal and external storage to copy files from each other. For example, copy an arbitrary wave file in the U-disk to the instrument, the procedure is as follows:

### 1. Choose the file type.

Press **Store/Recall** → **File Type**, and choose "Data" as the storage type.

**2. Choose the file to be copied.**

Rotate the knob to select USB Device (0:) and press the knob to open its directory. Then rotate the knob to select the file you want to copy and press **Page 1/2** → **Copy**.

**3. Paste the file.**

Rotate the knob to select Local (C:) and press the knob to open its directory. Then press **Paste**.

## 2.13 To Set Utility Function

With the Utility function, the user can set the parameters of the generator such as Sync, Interface, System Setting, Self Test and Frequency Counter, etc. Press **Utility** to enter the utility menu, as shown in Figure 2-46 and Figure 2-47.

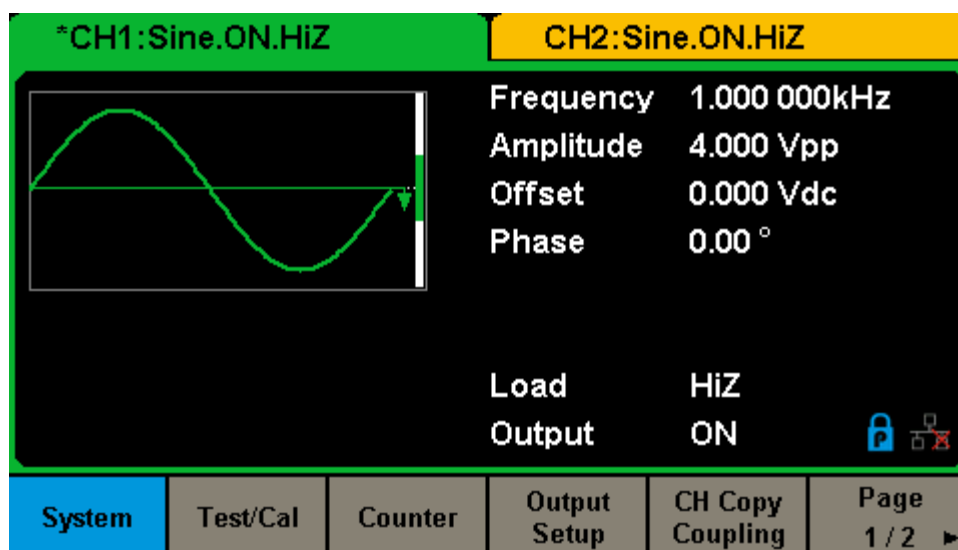

Figure 2-46 Utility Setup Interface (Page 1/2)

Table 2-27 Menu Explanations of Utility (Page1/2)

Function Menu	Settings	Explanation
System		Set the system configuration.
Test/Cal		Test and calibrate the instrument.
Counter		Frequency counter setting.
Output Setup		Set the output parameters of CH1 and CH2.
CH Copy Coupling		Set the track, channel coupling or channel copy function.
Page 1/2		Enter the next page.

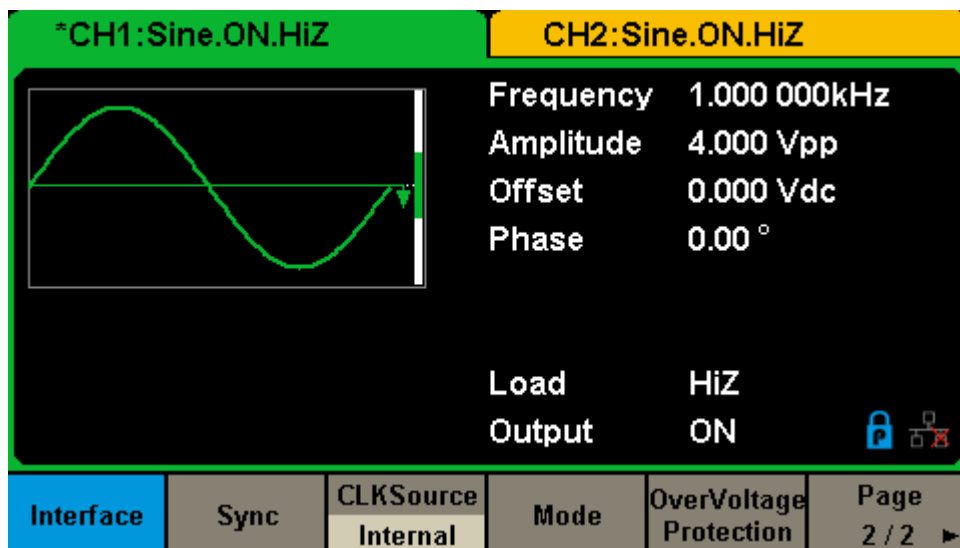

Figure 2-47 Utility Setup Interface (Page 2/2)

Table 2-28 Menu Explanations of Utility (Page2/2)

Function Menu	Settings	Explanation
Interface		Set the parameters of remote interfaces.
Sync		Set the sync output.
CLKSource	Internal	Choose the system clock source.
	External	
Help		View the help information.
OverVoltage Protection		Turn on/off the overvoltage protection function.
Page 2/2		Return to the previous page.

## 2.13.1 System Settings

Press **Utility** → **System**, to enter the following interface.

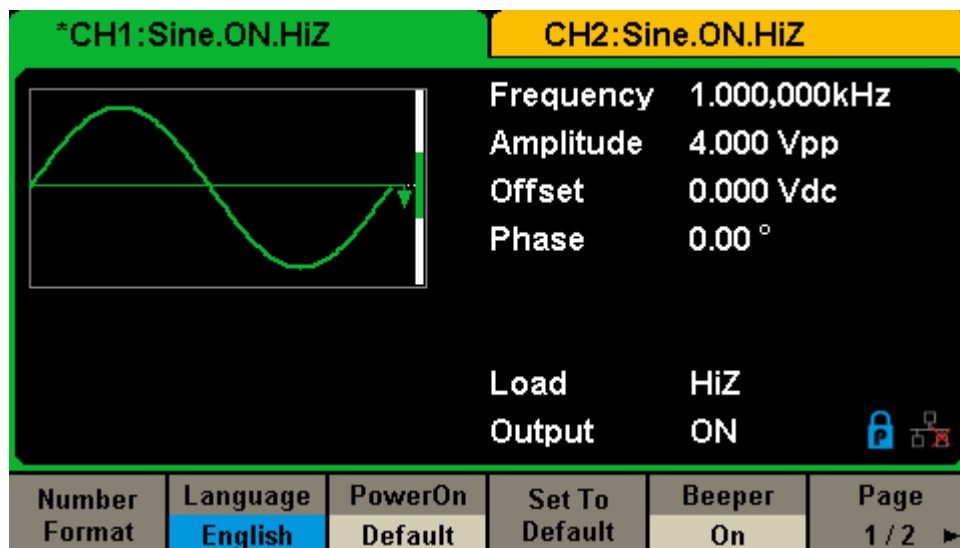

Figure 2-48 System Setup Interface (Page 1/2)

Table 2-29 Menu Explanations of System Setup (Page 1/2)

Function Menu	Settings	Explanation
Number format		Set the number format.
Language	English	Set the language.
	Chinese	
PowerOn	Default	All the settings return to default when power on;
	Last	All the settings return to the setting of last power on.
Set to Default		Set all the settings to default.
Beeper	On	Open the beeper.
	Off	Close the beeper.
Page 1/2		Enter the next page.

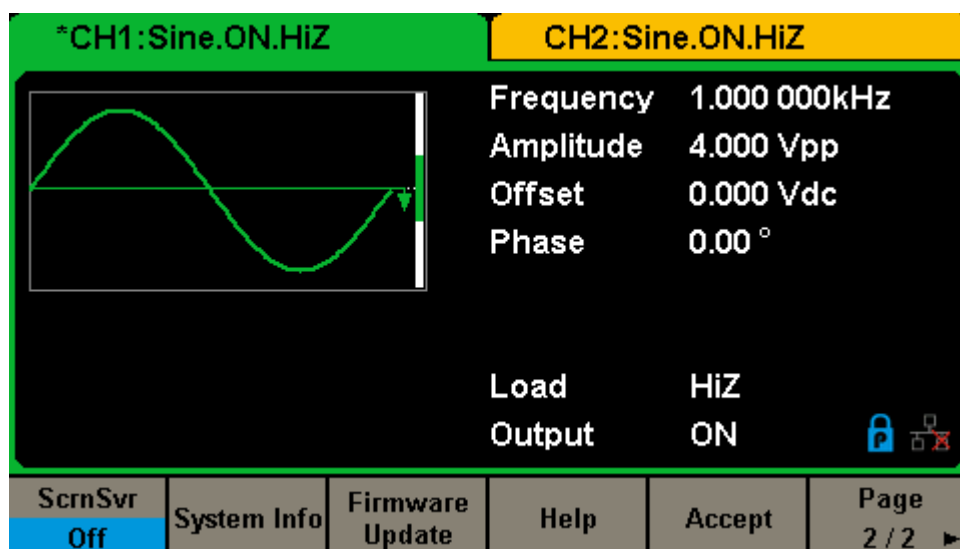

Figure 2-49 System Setup Interface (Page 2/2)

Table 2-30 Menu Explanations of System Setup (Page 2/2)

Function Menu	Settings	Explanation
ScrnSvr	1min	Enable or disable the screen saver.
	5min	
	15min	
	30min	
	1hour	
	2hour	
	5hour	
	Off	Disable the screen saver.
System Info		View the system information
Firmware Update		Update the firmware by the U-disk.
Bandwidth Update		Update the bandwidth of the generator.
Done		Save the current settings and return to the Utility menu.
Page 2/2		Return to the previous page.

## 1. Number Format

Press **Utility** → **System** → **Number Format**, to enter the following interface.



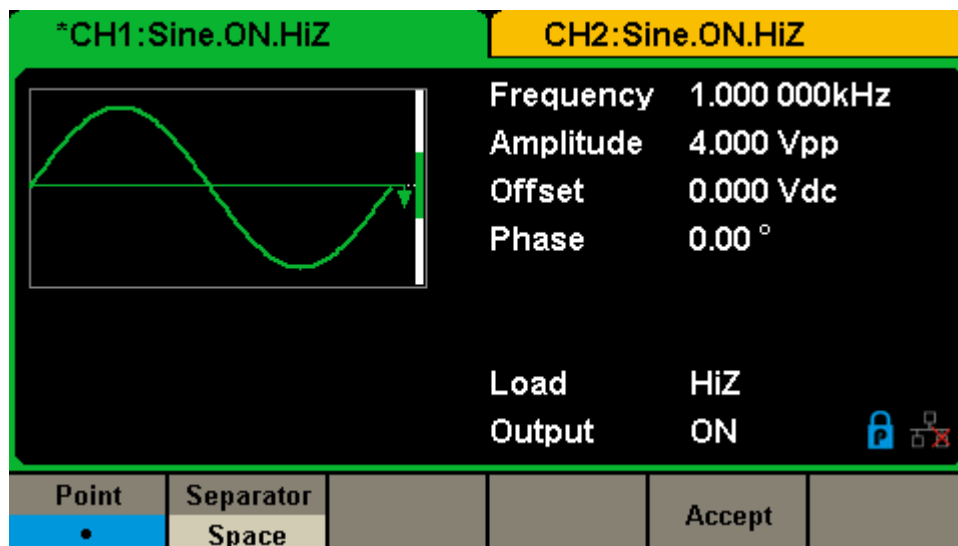

Figure 2-50 Set the Number Format

Table 2-31 Menu Explanations of Setting the Number Format

Function Menu	Settings	Explanation
Point	.	Use dot to represent decimal point;
	,	Use comma to represent decimal point.
Separator	On	Enable the Separator;
	Off	Close the Separator;
	Space	Use Space as the separator.
Done		Save the current settings and return to the System menu.

According to the different choices of the decimal point and the separator, the format can have various forms.

## 2. Language Setup

The generator offers two languages (English and Simplified Chinese). Press **Utility** → **System** → **Language**, to select the desired language. This setting is stored in non-volatile memory and will not be influenced by the **Set To Default** operation.

### English Interface

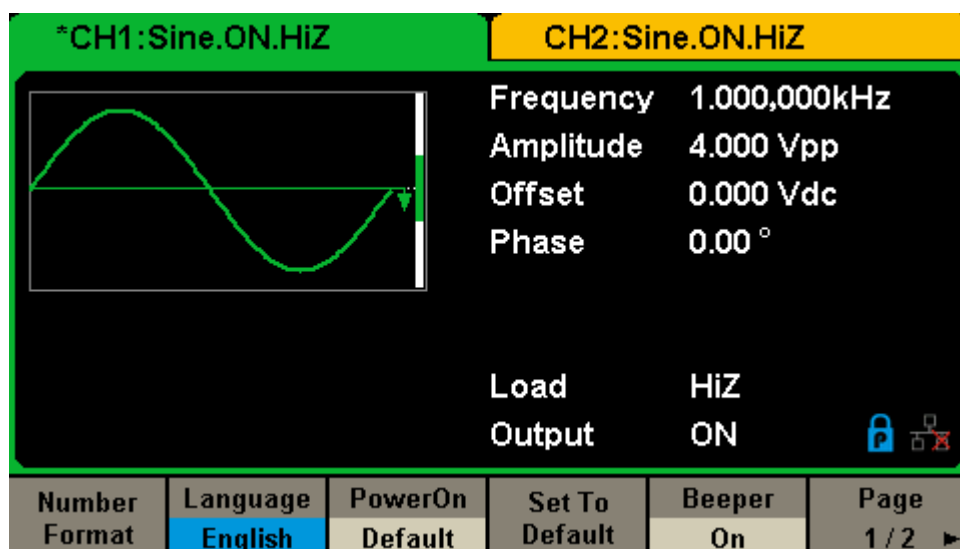

Figure 2-51 English Interface

### Chinese Interface

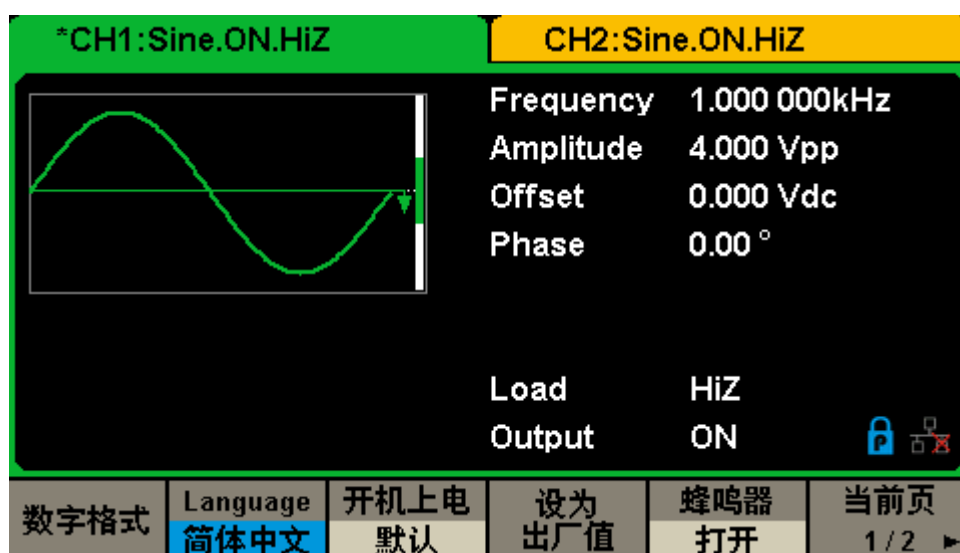

Figure 2-52 Chinese Interface

### 3. Power On

Choose the SDG2000X's setting when the generator is powered on. Two choices are available: the default setting and the last settings set when the unit was last powered down. Once selected, the setting will be applied when the instrument is powered on. This setting is stored in non-volatile memory and will not be influenced by the **Set To Default** operation.

- Last: includes all system parameters and states, except channel output state.
- Default: denotes the factory defaults except certain parameters (such as Language).

#### 4. Set to Default

Press **Utility** → **System** → **Set To Default**, to set the system to the default setting. The default settings of the system are as followed:

Table 2-32 Factory Default Setting

<b>Output</b>	<b>Default</b>
Function	Sine Wave
Frequency	1kHz
Amplitude/Offset	4Vpp/0Vdc
Phase	0°
Load	High Z
<b>Modulation</b>	<b>Default</b>
Carrier	1kHz Sine Wave
Modulating	100Hz Sine Wave
AM Depth	100%
FM Deviation	100Hz
ASK Key Frequency	100Hz
FSK Key Frequency	100Hz
FSK Hop Frequency	1MHz
PSK Key Frequency	100Hz
PM Phase Deviation	100°
PWM Width Dev	190μs
<b>Sweep</b>	<b>Default</b>
Start/Stop Frequency	500Hz/1.5kHz
Sweep Time	1s
Trig Out	Off
Mode	Linear

Direction	↑
<b>Burst</b>	<b>Default</b>
Burst Period	10ms
Start Phase	0°
Cycles	1Cycle
Trig Out	Off
Delay	521ns
<b>Trigger</b>	<b>Default</b>
Source	Internal

## 5. Beeper

Enable or disable the beeper. Press **Utility** → **System** → **Beeper** to select “On” or “Off” and the default is “On”.

## 6. Screen Saver

Enable or disable screen saver. Press **Utility** → **System** → **Page 1/2** → **ScrnSvr** to select “On” or “Off” and the default is “Off”. Screen saver will be on if no action is taken within the time that you have selected. Click the touch screen or Press any key to resume.

## 7. System Info

Select the **System Info** option of the utility menu to view the generator’s system information, including startup times, software version, hardware version, model and serial number.



Figure 2-53 System Information Interface

## 8. Update

The software version and configuration file of the generator can be updated directly via U-disk. Follow the steps below:

1. Insert U-disk with firmware update file (\*.ADS) and configuration file (\*.CFG) to USB host interface on the front panel of the generator.
2. Press **Utility** → **Page 1/2** → **Firmware Update**. Or press **Store/Recall** directly.
3. Select the firmware file (\*.ADS) and choose **Recall** to update the system software.
4. After the updating is finished, the generator will restart automatically.

### Note:

1. Don't cut off the power during the generator is being updated!
2. A configuration file (\*.CFG) may or may not be included with a given firmware update. If a CFG file is not included with a firmware update then it will not be required for that update.

## 9. Built-in Help System

The SDG2000X provides a built-in help system, by which users can view the help information at any time when operating the instrument. Press **Utility** → **System** → **Page 1/2** → **Help** to enter the following interface.

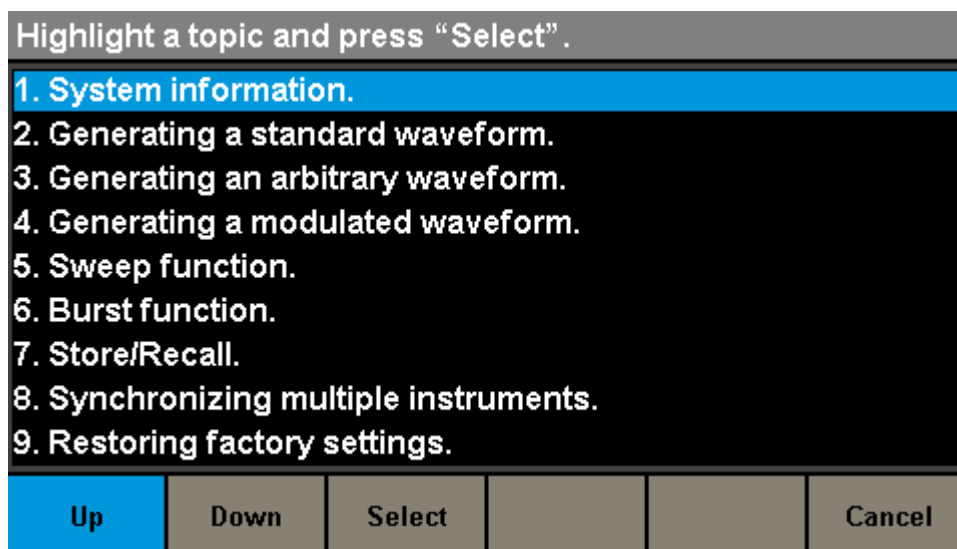

Figure 2-54 Help Menu

Figure 2-55 Help Menu Explanations

Function Menu	Settings	Explanation
UP		Cursor upward to select.
Down		Cursor downward to select.
Select		Read the currently selected help information.
Cancel		Exit the built-in help system.

There are 10 topics in the help list. You can use the knob and/or operation menus to select the help information that you want to read.

## 2.13.2 Test/Cal

Choose **Utility** → **Test/Cal**, to enter the following interface.

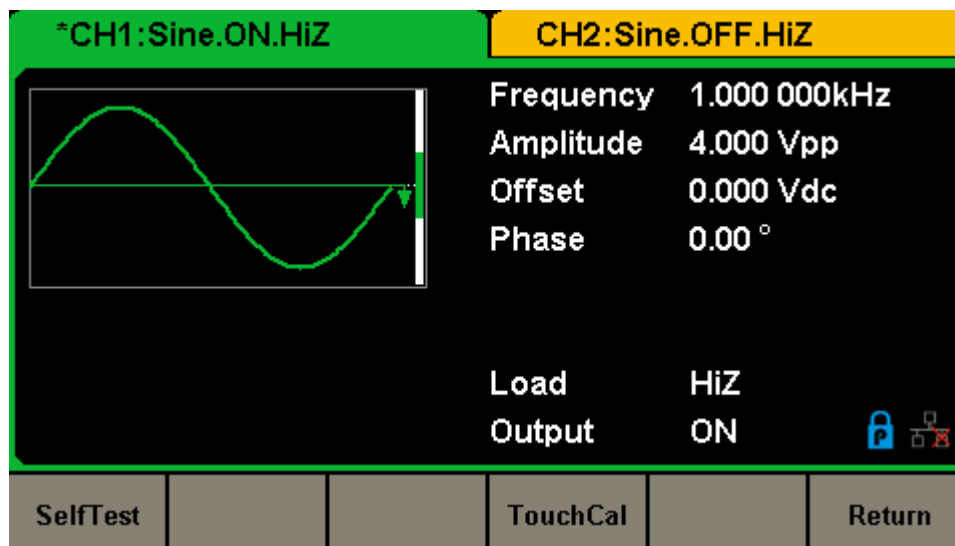

Figure 2-56 Test/Cal function Menu

Table 2-33 Menu Explanations of Test/Cal Setting

Function Menu	Settings	Explain
SelfTest		Perform a system self-test.
TouchCal		Do a touch screen calibration.
Return		Return to the Utility menu.

### Self Test

Press **Utility** → **Test/Cal** → **SelfTest**, to enter the following menu.

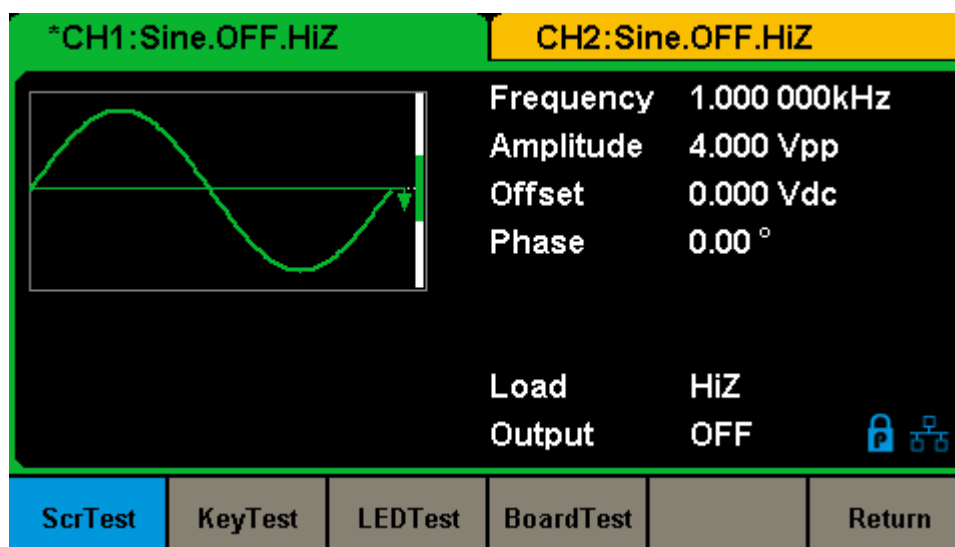

Figure 2-57 Self Test Interface

Table 2-34 Menu Explanations of Self Test

Function Menu	Settings	Explain
ScrTest		Run screen test program.
KeyTest		Run keyboard test program.
LEDTest		Run key indicator lights test program.
BoardTest		Run hardware circuit self-test program.
Cancel		Return to the Test/Cal menu.

### 1. ScrTest

Select **ScrTest** to enter the screen test interface. The prompt message 'Please press '7' key to continue, press '8' key to exit.' is displayed. Press the '7' key for test and observe if there is any serious color deviation, bad pixel or display error.



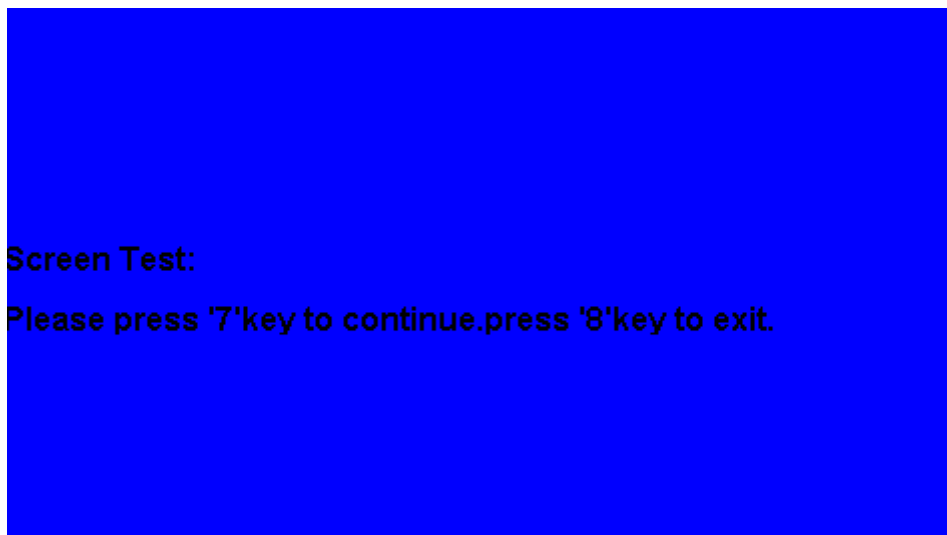

Figure 2-58 Screen Test Interface

## 2. Key Test

Select **KeyTest** to enter the keyboard test interface, the on-screen white rectangle shapes represent the front panel keys. The circle between two arrows represents the knob. Test all keys and knob and also verify that all the backlight keys illuminate correctly.

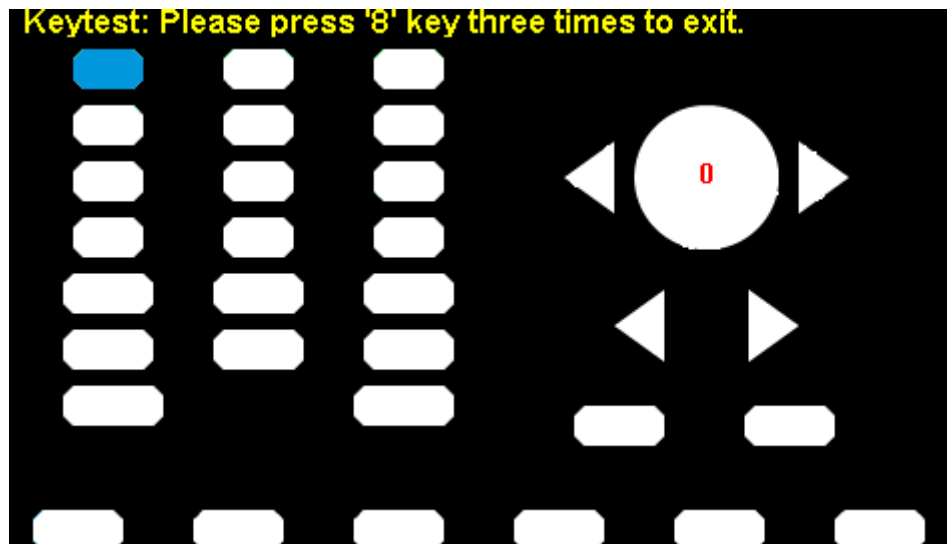

Figure 2-59 Key Test Interface

The corresponding area of tested keys or knob would display in blue color. The top of the screen displays 'Please press '8' key three times to exit.'

## 3. LED Test

Select **LEDTest** to enter the LED test interface, the on-screen white rectangle

shapes represent the front panel keys. The prompt message 'Please press '7' Key to continue, press '8' Key to exit.' is displayed. Press the '7' key continuously for testing and when a key is lighted, the corresponding area on the screen will display in blue color.

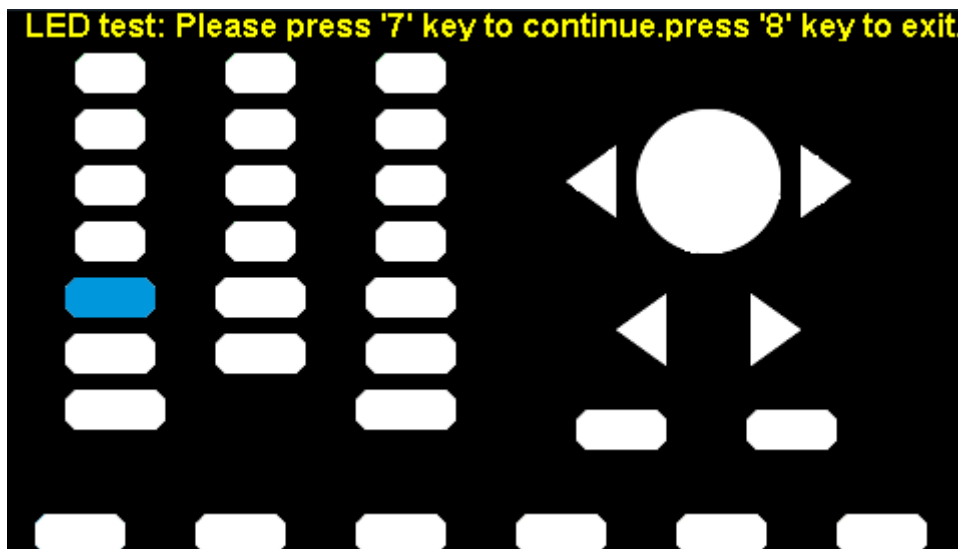

Figure 2-60 LED Test Interface

#### 4. Board Test

Select **BoardTest** to enter the following interface.

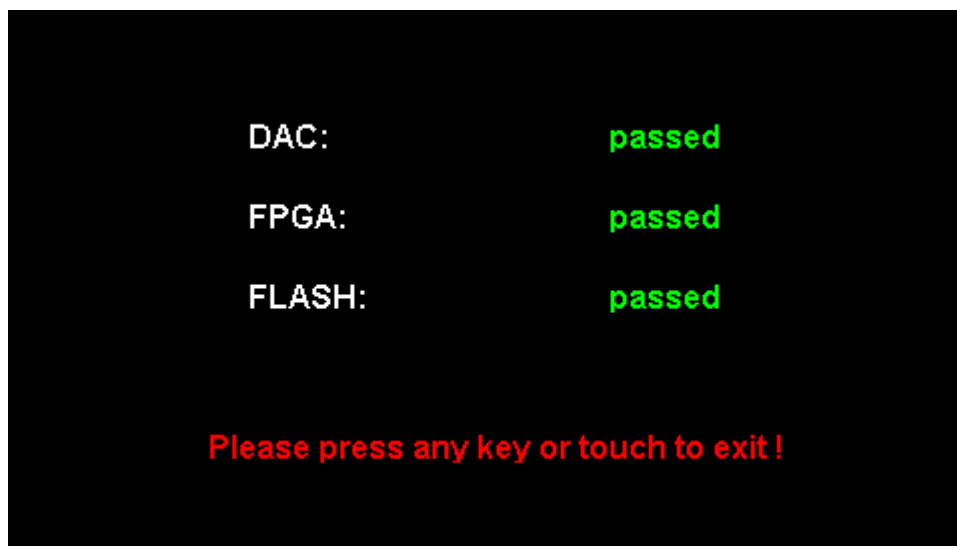

Figure 2-61 Board Test Interface

#### Touch Adjust

Use the function regularly to calibrate the touch screen, which makes it more accurate when the finger or touch pen touches the screen and avoids any

misoperation.

Press **Utility** → **Test/Cal** → **TouchCal**, to enter the following interface.

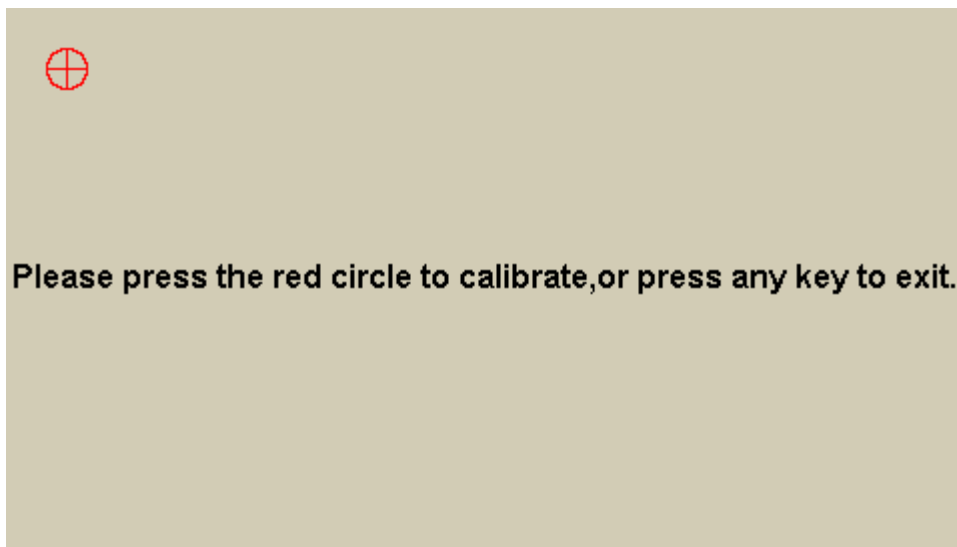

Figure 2-62 Touch Adjust Interface

According to the message, click the red circle on the upper left corner, upper right corner, lower left corner and lower right corner of the screen in sequence. After touch calibration is done, the system will display the following tip. Then press any key or touch the screen to exit the current interface.

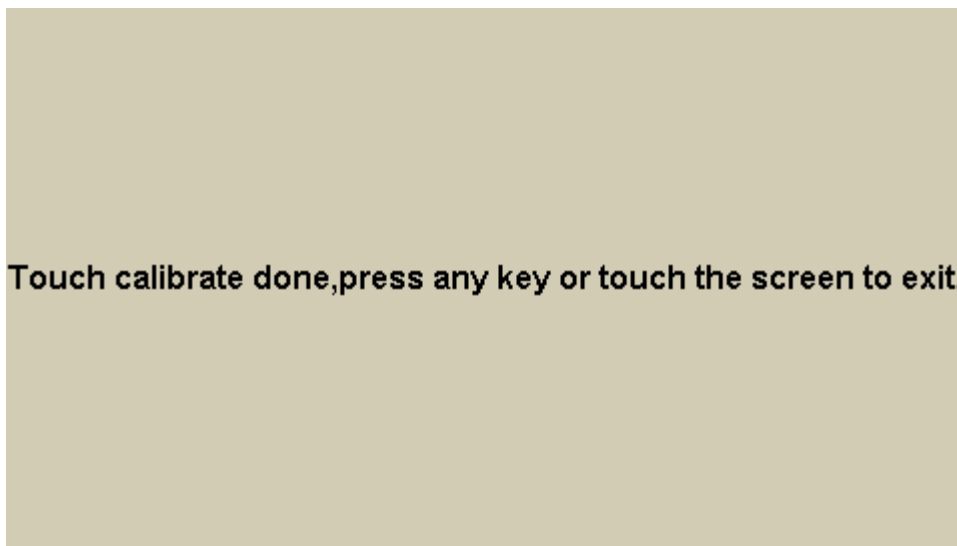

Figure 2-63 Touch Adjust Done

## 2.13.3 Frequency Counter

The SDG2000X provides a frequency counter which could measure frequencies between 100MHz to 200MHz. The dual channels can still output normally when the counter is enabled. Press **Utility** → **Counter**, to enter the following interface.

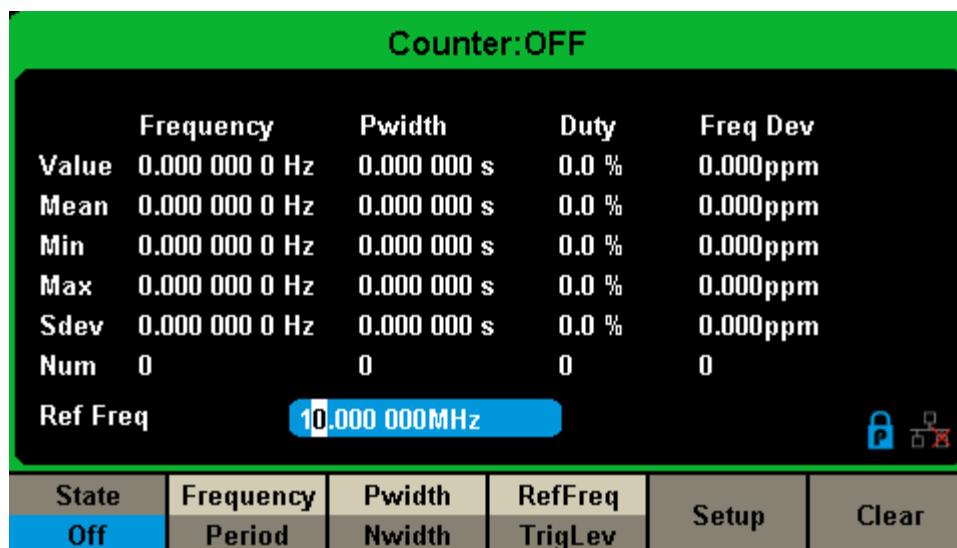

Figure 2-64 Frequency Counter Interface

Table 2-35 Menu Explanations of Frequency Counter

Function Menu	Settings	Explanation
State	Off	Open the counter.
	On	Close the counter.
Frequency		Measured frequency.
Period		Measured period.
PWidth		Measured positive width.
NWidth		Measured negative width.
RefFreq		Set the reference frequency. System will calculate the deviation between the measured frequency and the reference frequency automatically.
TrigLev		Set the trigger level voltage.
Duty		Measured duty.
Setup		Set the counter configuration.
Cancel		Exit the frequency counter interface.

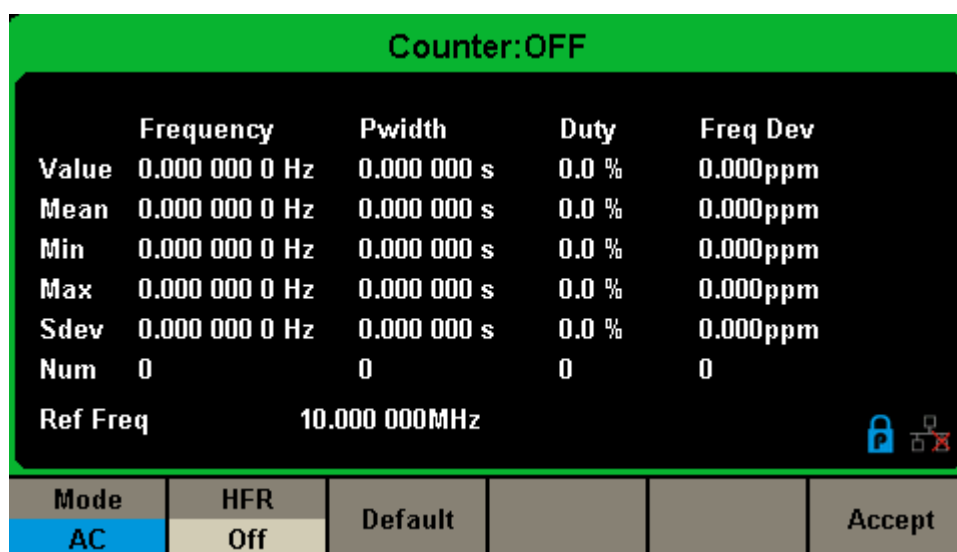

Figure 2-65 Counter Setup Interface

Table 2-36 Menu Explanations of Setup

Function Menu	Settings	Explanation
Mode	DC	Set the coupling mode to DC
	AC	Set the coupling mode to AC
HFR	On	Open the high frequency rejection filter.
	Off	Close the high frequency rejection filter.
Default		Set the frequency counter settings to default.
Done		Save the current settings and return to the previous menu.

### 1. To Select the Parameters to be measured

The frequency counter on the SDG2000X can measure parameters including frequency, period, duty, positive pulse width and negative pulse width.

### 2. Reference Frequency

System will calculate the deviation between the measured frequency and the reference frequency automatically.

### 3. Trigger Level

Sets the trigger level of the measurement system. The system triggers and obtains the measurement readings when the input signal reaches the specified trigger level. The default is 0V and the available range is from -3V to 1.5V. Choose **TrigLev** and use the numeric keyboard to input the desired value and select the unit (V or mV) from the pop-up menu. Or use the knob and arrow keys to change the parameter value.

#### **4. Coupling Mode**

Sets the coupling model of the input signal to “AC” or “DC”. The default is “AC”.

#### **5. HFR**

High Frequency Rejection can be used to filter out the high-frequency components of a measured signal and improve the measurement accuracy in low-frequency signal measurement. Press **HFR** to enable or disable this function. The default is “Off”.

- Enable High Frequency Rejection when low-frequency signal with lower than a 250kHz frequency is measured to filter out the high-frequency noise interference.
- Disable High Frequency Rejection when a signal with a frequency higher than 250 KHz is measured. The maximum frequency that can be counted is 200 MHz.

## 2.13.4 Output

Press **Utility** → **Output** to enter the following interface.

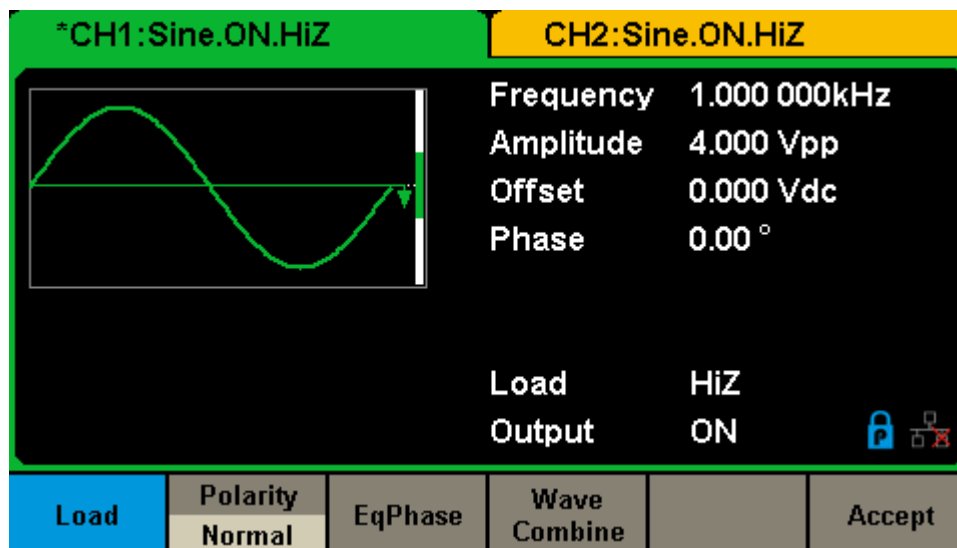

Figure 2-66 Output Setup Interface

### Load

For the [CH1] and [CH2] connectors on the front panel, the generator has an output impedance of 50Ω. If the actual load does not match the set load, the displayed voltage will not be the same as the output voltage. This function is used to match the displayed voltage with the expected one. This setting does not actually change the output impedance to any other value.

#### Steps for setting the load:

Press **Utility** → **Output Setup** → **Load**, to set the output load. The load parameter shown on the down bottom is the default setting when the power is on or the pre-set load value.

High Impedance: displayed as HiZ;

Load: the default is 50Ω and the range is 50Ω to 100kΩ.

#### Note:

Continue pressing the corresponding output key for two seconds to switch between High Impedance and 50Ω.

## Polarity

Press **Utility** → **Output Setup** → **Polarity** to set the output signal as normal or inverted. The waveform's inversion is relative to the offset voltage, as shown in the following figure.

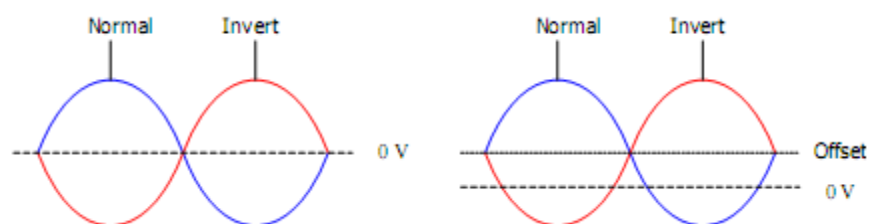

### Note:

The Sync signal related to the waveform is not inverted when the waveform is inverted.

## EqPhase

Press **Utility** → **Output Setup** → **EqPhase** to align the phases of CH1 and CH2. Choosing the menu will re-configure two channels and enable the generator to output with specified frequency and start phase. For two signals whose frequencies are the same or a multiple thereof, this operation will align their phases.

## Waveforms Combining

The CH1 output port of the SDG2000X outputs the waveform of CH1 in the general mode, while the waveform of CH1+CH2 can be output in the combined mode. Similarly, the CH2 output port of SDG2000X outputs the



waveform of CH2 in the general mode while the waveform of CH1+CH2 can be output in the combined mode.

Press **Utility** → **Output Setup** → **Wave Combine** to enter the waveforms combining interface, as shown in the following figure.

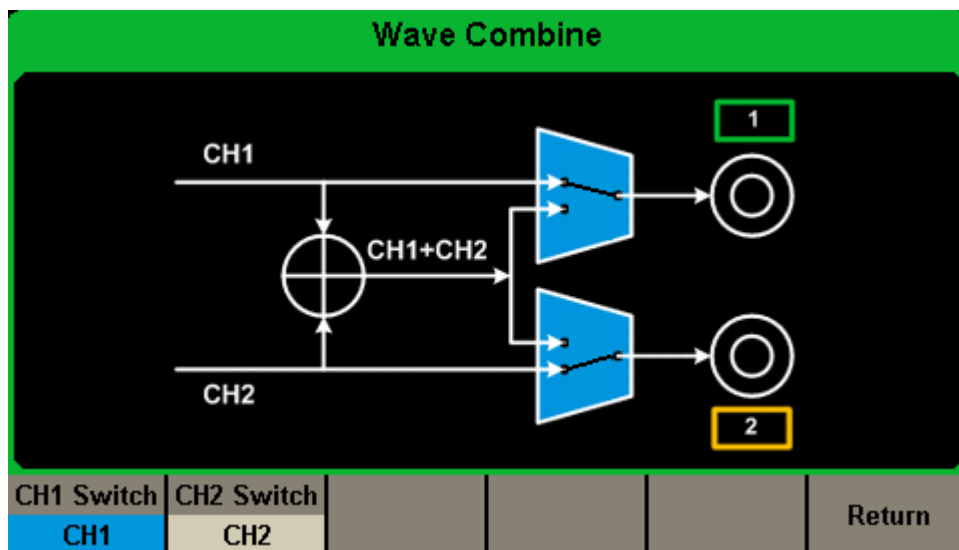

Figure 2-67 Waveforms Combining Interface

Table 2-37 Menu Explanations of Wave Combine

Function Menu	Settings	Explanation
CH1 Switch	CH1	Output the waveform of CH1.
	CH1+CH2	Output the waveform of CH1+CH2.
CH2 Switch	CH2	Output the waveform of CH2.
	CH1+CH2	Output the waveform of CH1+CH2.
Return		Save the current operation and exit the current interface.

**Note:**

When the waveforms combining function is enabled, the load of two channels will be set to the same automatically, default using the load value of the currently operated channel.

## 2.13.5 CH Copy/Coupling

### Channel Copy

The SDG2000X supports state and waveform copy function between its two channels. That is to say, it copies all parameters and states (including the channel output state) and arbitrary waveform data of one channel to the other one.

Press **Utility** → **CH Copy Coupling** → **Channel Copy**, to enter the following interface.

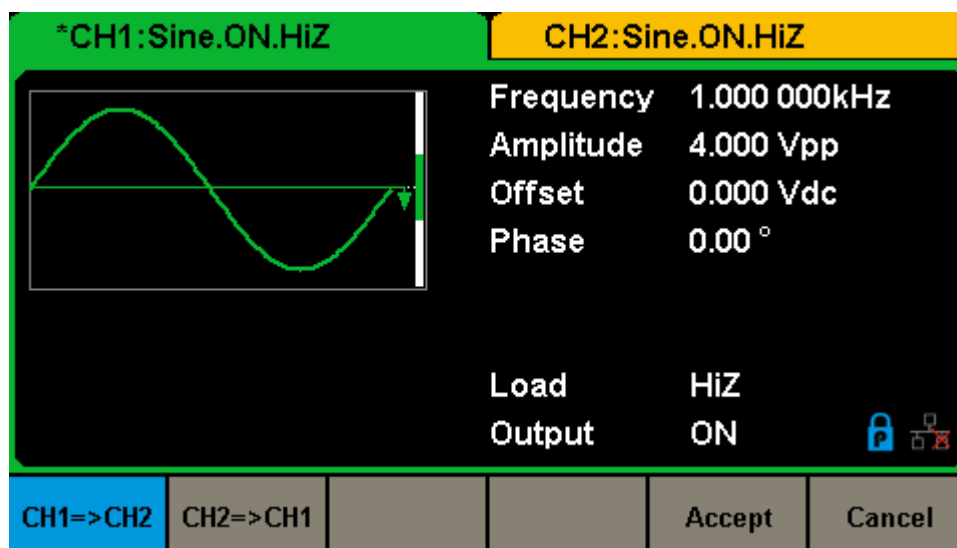

Figure 2-68 Channel Copy Interface

Table 2-38 Menu Explanations of Channel Copy

Function Menu	Settings	Explanation
CH1=>CH2		Copy all parameters and states of CH1 to CH2.
CH2=>CH1		Copy all parameters and states of CH2 to CH1.
Accept		Perform the current selection and return to the Utility menu.
Cancel		Give up the current selection and return to the Utility menu.

**Note:**

Channel coupling or track function and channel copy function are mutually exclusive. When channel coupling or track function is enabled, the menu **Channel Copy** is hidden.

### Channel Coupling

The SDG2000X supports frequency, amplitude and phase coupling. Users can set the frequency deviation/ratio, amplitude deviation/ratio or phase deviation /ratio of the two channels. When coupling is enabled, CH1 and CH2 can be modified simultaneously. When the frequency, amplitude or phase of one channel (as the reference) is changed, the corresponding parameter of the other channel will be changed automatically and always keeps the specified frequency deviation/ratio, amplitude deviation/ratio or phase deviation /ratio relative to the base channel.

Press **Utility** → **CH Copy Coupling** → **Channel Coupling**, to enter the following interface.

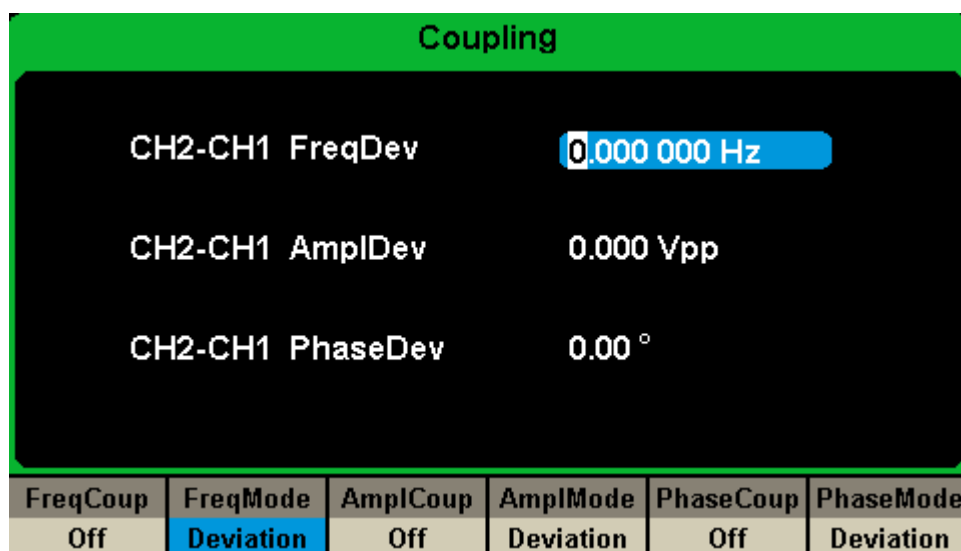

Figure 2-69 Channel Coupling Interface

### Frequency Coupling

1. To Enable Frequency Coupling Function

Press **FreqCouple** to turn frequency coupling “On” or “Off”. The default is “Off”.

## 2. To Select Frequency Coupling Mode

Press **FreqMode** to choose “Deviation” or “Ratio”, and then use the numeric keyboard or knob and arrow keys to input the desired value.

- Deviation: the frequency deviation between CH1 and CH2. The resulting signal is represented by:  $\text{FreqCH2} - \text{FreqCH1} = \text{FreqDev}$ .
- Ratio: the frequency ratio of CH1 and CH2. The resulting signal is represented by:  $\text{FreqCH2} / \text{FreqCH1} = \text{FreqRatio}$ .

## Amplitude Coupling

### 1. To Enable Amplitude Coupling Function

Press **AmplCoup** to turn amplitude coupling “On” or “Off”. The default is “Off”.

### 2. To Select Amplitude Coupling Mode

Press **AmplMode** to choose “Deviation” or “Ratio”, and then use the numeric keyboard or knob and arrow keys to input the desired value.

- Deviation: the amplitude deviation between CH1 and CH2. The resulting signal is represented by:  $\text{AmplCH2} - \text{AmplCH1} = \text{AmplDev}$ .
- Ratio: the amplitude ratio of CH1 and CH2. The resulting signal is represented by:  $\text{AmplCH2} / \text{AmplCH1} = \text{AmplRatio}$ .

## Phase Coupling

### 1. To Enable Phase Coupling Function

Press **PhaseCoup** to turn phase coupling “On” or “Off”. The default is “Off”.

### 2. To Select Phase Coupling Mode

Press **PhaseMode** to choose “Deviation” or “Ratio”, and then use the numeric keyboard or knob and arrow keys to input the desired value.

- Deviation: the phase deviation between CH1 and CH2. The resulting signal is represented by:  $\text{PhaseCH2} - \text{PhaseCH1} = \text{PhaseDev}$ .
- Ratio: the phase ratio of CH1 and CH2. The resulting signal is represented by:  $\text{PhaseCH2} / \text{PhaseCH1} = \text{PhaseRatio}$ .

## Key Points:

1. Channel coupling is only available when both the waveforms of the two channels are basic waveforms including Sine, Square, Ramp and Arbitrary.

2. When the Phase Coupling function is enabled, if the phase of one channel is changed, the phase of the other channel will be changed accordingly. At this point, aligning phase between the two channels can be achieved without executing the **Eqphase** operation.
3. Channel coupling and channel function are mutually exclusive. When channel coupling is enabled, the menu **Channel Copy** is hidden.

## Channel Track

When the track function is enabled, by changing the parameters or states of CH1, the corresponding parameters or states of CH2 will be adjusted to the same values or states automatically. At this point, the dual channels can output the same signal.

Choose **Utility** → **CH Copy Coupling** → **Track** to enable or disable the track function. When the track function is enabled, channel copy and coupling functions are disabled; the user interface is switched to CH1 and cannot be switched to CH2, as shown in the following figure.

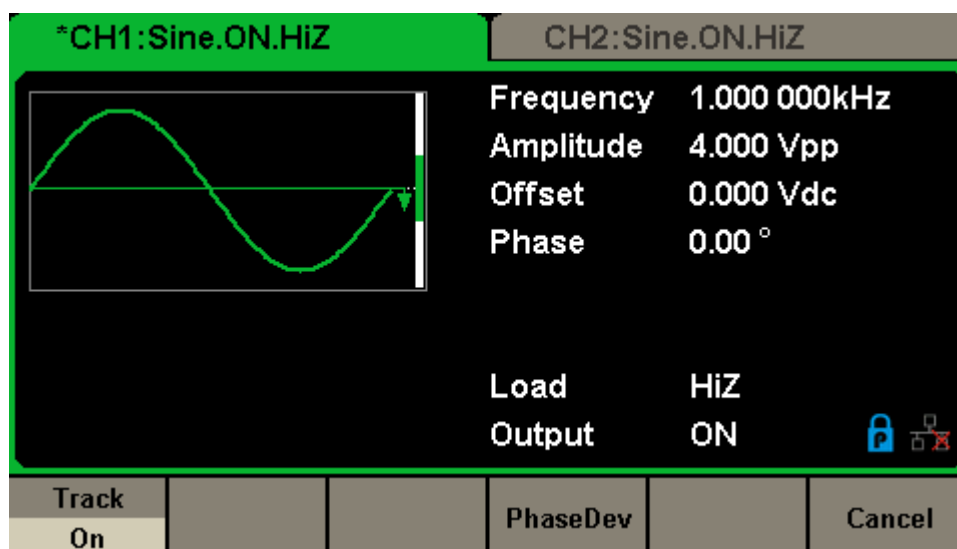

Figure 2-70 Track Interface

- Press PhaseDev to enter the following interface. Then use the numeric keyboard or knob and arrow keys to input the desired value for the phase deviation between CH1 and CH2. The resulting signal is represented by:

$\text{Phase}_{\text{CH2}} - \text{Phase}_{\text{CH1}} = \text{PhaseDev}$ .

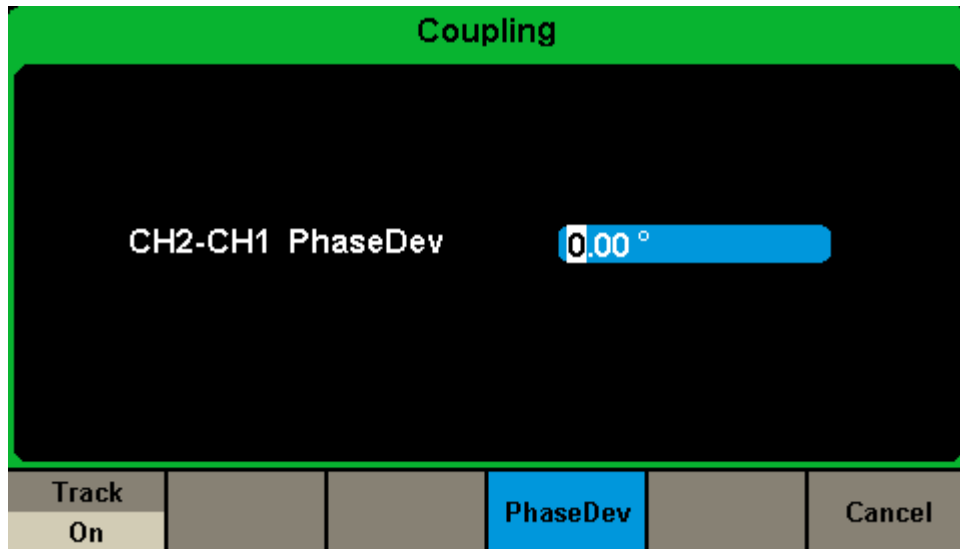

Figure 2-71 Phase Deviation Interface

## 2.13.6 Remote Interface

The SDG2000X can be controlled remotely via USB, LAN and GPIB (option) interfaces. Users can set the corresponding interface according to their needs.

Press **Utility** → **Page 1/2** → **Interface** to open the following menu. The user can set LAN parameters or GPIB address.

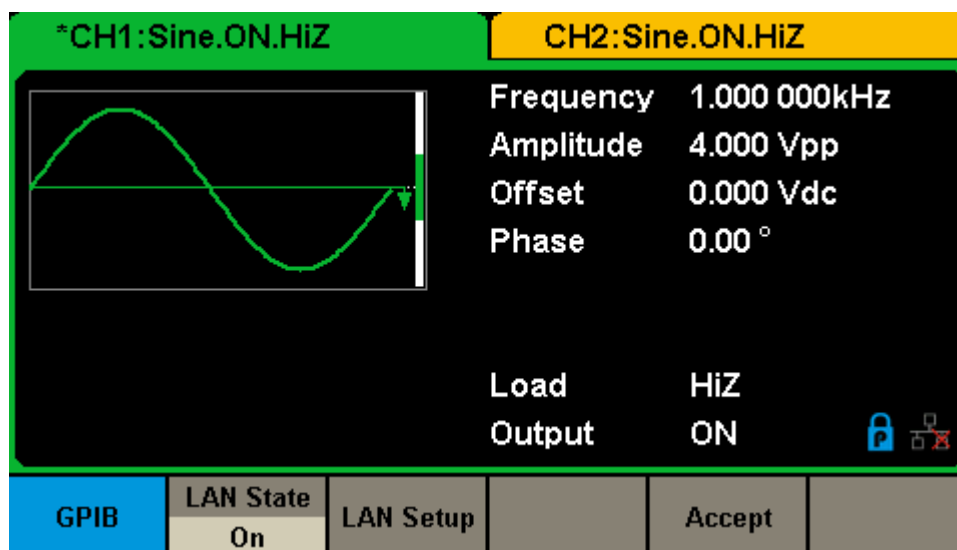

Figure 2-72 Interface Settings

Table 2-39 Menu Explanations of Interface

Function Menu	Settings	Explanation
GPIB		Set the GPIB address.
LAN State	On	Turn on LAN.
	Off	Turn off LAN.
LAN Setup		Set the IP address, subnet mask and gateway.
Accept		Save the current settings and return to the Utility menu.

The SDG2000X can be controlled remotely via the following two methods:

1. User-defined programming

Users can program and control the instrument by using the SCPI commands (Standard Commands for Programmable Instruments). For more information about the commands and programming, please refer to “Remote Control Manual”.

## 2. PC software

Users can use the PC software Measurement & Automation Explorer of NI (National Instruments Corporation) to send commands to control the instrument remotely.

### **Remote Control via USB**

The SDG2000X can communicate with a PC through the USBTMC protocol. You are suggested to do as the following steps.

#### 1. Connect the device.

Connect the USB Device interface at the rear panel of SDG2000X with the PC via a USB cable.

#### 2. Install the USB driver.

NI Visa is recommended.

#### 3. Communicate with a remote PC

Open Measurement & Automation Explorer of NI and choose the corresponding resource name. Then click “Open VISA Test Panel” to turn on the remote command control panel through which you can send commands and read data.

### **Remote Control via GPIB**

Each device connected to GPIB interface must have a unique address. The



default value is 18 and values range from 1 to 30. The selected address is stored in non-volatile memory.

1. Connect the device.

Connect the generator to the computer using a USB to GPIB adapter (option).

**Note:**

Please make sure that the PC has a GPIB interface card installed.

Connect the USB terminal of the USB to GPIB adapter to the USB Host interface at the front panel of the generator and the GPIB terminal to the GPIB card terminal of the PC.

2. Install the driver of GPIB card.

Please install the driver for the GPIB card which has been connected to your PC.

3. Set the GPIB address.

Choose **Utility** → **Page 1/2** → **Interface** → **GPIB** to enter the following interface. Users can use the knob, arrow keys or numeric keyboard to change the value and press **Accept** to save the current setting.

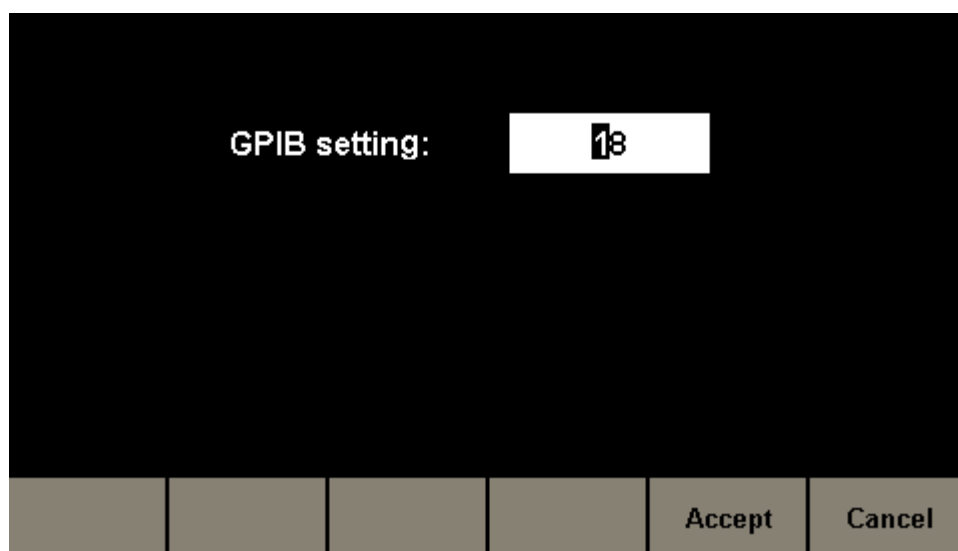

Figure 2-73 GPIB Setting Interface

4. Communicate with PC remotely

Open Measurement & Automation Explorer of NI. After adding the GPIB device successfully, choose the corresponding resource name. Then click “Open VISA Test Panel” to turn on the remote command control panel through which you can send commands and read data.

## Remote Control via LAN

The SDG2000X can communicate with a PC through LAN interface. Users can view and modify the LAN parameters.

1. Connect the device.

Connect the generator to your PC or the LAN of your PC using a network cable.

2. Configure network parameters.

Choose **Utility** → **Page 1/2** → **Interface** → **LAN State** to turn on LAN. Then choose **LAN Setup** to enter the following interface.

The screenshot shows a dark-themed interface for LAN settings. It features three input fields for network parameters:

- IP Address:** 10 . 11 . 13 . 23
- Subnet Mask:** 255 . 0 . 0 . 0
- Gateway:** 10 . 11 . 13 . 1

At the bottom, there is a navigation bar with the following buttons:

<b>IP Address</b>	Subnet Mask	Default Gateway	DHCP Off	Accept	Cancel
-------------------	-------------	-----------------	----------	--------	--------

Figure 2-74 LAN Settings Interface

1) To Set IP Address

The format of IP address is nnn.nnn.nnn.nnn. The first nnn ranges from 1 to 223 and the others range from 0 to 255. You are recommended to acquire an

available IP address from your network administrator.

Press **IP Address** and use the arrow keys and numeric keyboard or knob to enter your desired IP address. The setting is stored in non-volatile memory and will be loaded automatically when the generator is powered on at the next time.

## 2) To Set Subnet Mask

The format of subnet mask is nnn.nnn.nnn.nnn and each nnn ranges from 0 to 255. You are recommended to acquire an available subnet mask from your network administrator.

Press **Subnet Mask** and use the arrow keys and numeric keyboard or knob to enter your desired subnet mask. The setting is stored in non-volatile memory and will be loaded automatically when the generator is powered on at the next time.

## 3) To Set Gateway

The format of gateway is nnn.nnn.nnn.nnn and each nnn ranges from 0 to 255. It is recommended to acquire an available gateway from your network administrator.

Press **Gateway** and use the arrow keys and numeric keyboard or knob to enter your desired gateway. The setting is stored in non-volatile memory and will be loaded automatically when the generator is powered on at the next time.

### **Note:**

- If the generator is connected to the PC directly, set the IP addresses, subnet masks and gateways for both of the PC and generator. The subnet masks and gateways of PC and generator must be the same and the IP addresses of them must be within the same network segment.
- If the generator is connected to the LAN of your PC, please contact with

your network administrator to get an available IP address. For details, refer to the TCP/IP protocol.

#### 4) DHCP Configuration Mode

In DHCP mode, the DHCP server in the current network assigns LAN parameters, e.g. IP address, for the generator. Press **DHCP** to select “On” or “Off” to turn DHCP mode on or off. The default is “Off”.

#### 3. Communicate with PC remotely

Open Measurement & Automation Explorer of NI. After adding the LAN device (VISA TCP/IP Resource...) successfully, choose the corresponding resource name. Then click “Open VISA Test Panel” to turn on the remote command control panel through which you can send commands and read data.

## 2.13.7 Sync Output

The generator provides Sync output through the [Aux In/Out] connector on the rear panel. When the synchronization is on, the port can output a CMOS signal with the same frequency as basic waveforms (except Noise and DC), arbitrary waveforms, and modulated waveforms (except external modulation).

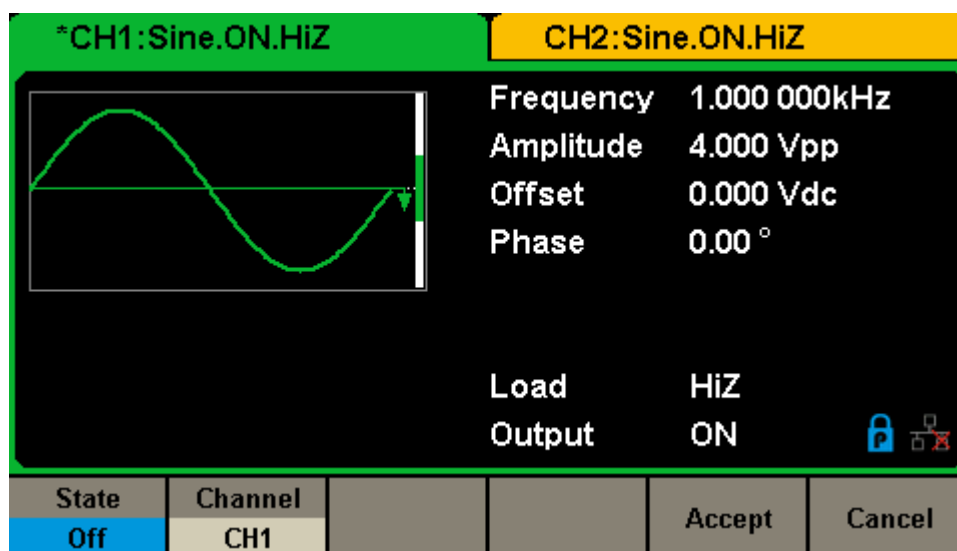

Figure 2-75 Sync Output Interface

Table 2-40 Menu Explanations of Sync Output

Function Menu	Settings	Explanation
State	Off	Close the sync output
	On	Open the sync output
Channel	CH1	Set the sync signal of CH1.
	CH2	Set the sync signal of CH2.
Accept		Save the current settings and return to the Utility menu.
Cancel		Give up the current settings and return to the Utility menu.

### Sync Signals of Different Waveforms:

#### Basic Waveform and Arbitrary Waveform

- 1) When the frequency of the waveform is less than or equal to 10MHz, the sync signal is a Pulse with 50ns pulse width and the same frequency as

the waveform.

- 2) When the frequency of the waveform is greater than 10MHz, there is no sync signal output.
- 3) Noise and DC: there is no sync signal output.

### **Modulated Waveform**

- 1) When internal modulation is selected, the sync signal is a Pulse with 50ns pulse width.

For AM, FM, PM and PWM, the frequency of the sync signal is the modulating frequency.

For ASK, FSK and PSK, the frequency of the sync signal is the key frequency.

- 2) When external modulation is selected, there is no sync signal output, for the [Aux In/Out] connector on the rear panel is used to input external modulating signal.

### **Sweep and Burst Waveform**

When Sweep or Burst function is turned on, there is no sync signal output and the Sync menu is hidden.

## 2.13.8 Clock Source

The SDG2000X provides an internal 10MHz clock source. It also can accept external clock source from the [10 MHz In/Out] connector at the rear panel. It can also output the clock source from the [10 MHz In/Out] connector for other devices.

Press **Utility** → **Page 1/2** → **Clock** → **Source** to select “Internal” or “External”. If “External” is selected, the instrument will detect whether a valid external clock signal is input from the [10MHz In/Out] connector at the rear panel. If not, the prompt message “No external clock source!” would be displayed and the clock source would be switched to “Internal”.

### Sync methods for two or more instruments:

#### ● Synchronization between two instruments

Connect the [10MHz In/Out] connector of generator A (using internal clock) to the [10MHz In/Out] connector of generator B (using external clock) and set the output frequencies of A and B as a same value to realize synchronization.

#### ● Synchronization among multiple instruments

Divide the 10MHz clock source of a generator (using internal clock) into multiple channels, and then connect them to the [10MHz In/Out] connectors of other generators (using External clock), and finally set the output frequencies of all the generators as a same value to realize synchronization.

## 2.13.9 Mode

Press **Utility** → **Page 1/2** → **Mode** to enter the mode setup Interface, as shown in Figure 2-76.

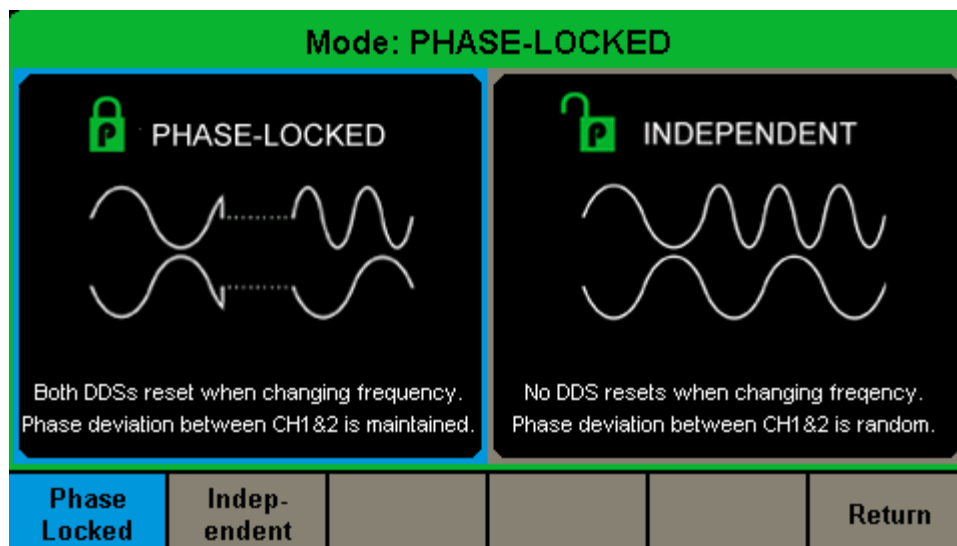

Figure 2-76 Mode Setup Interface

### Phase-locked Mode

When changing the frequency, the DDSs of both channels reset, and the phase deviation between CH1 and CH2 is maintained.

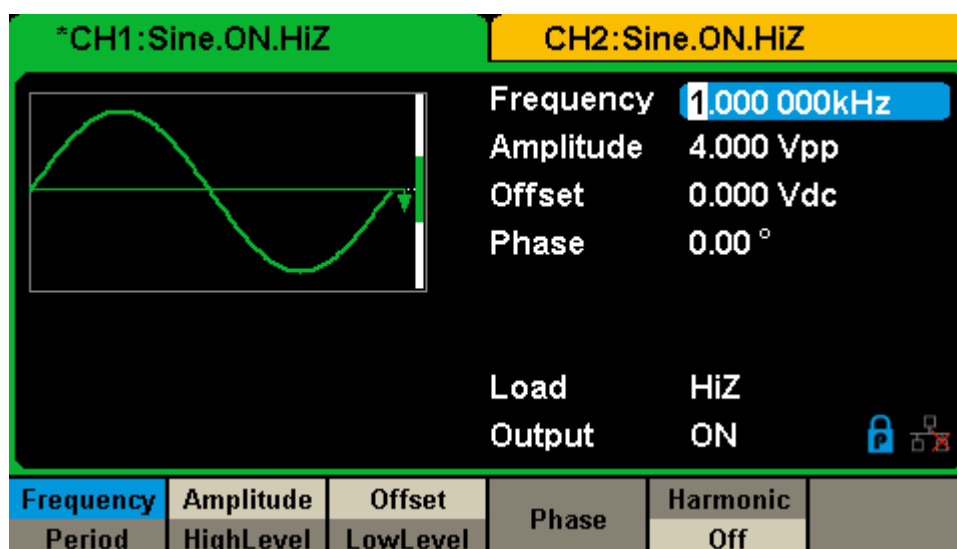

Figure 2-77 Phase-locked Mode



### Independent Mode

When changing the frequency, neither channels' DDS resets and the phase deviation between CH1 and CH2 changes at random. When the independent mode is enabled, the phase parameter cannot be modified and the menu **Phase** is hidden, as shown in Figure 2-78.

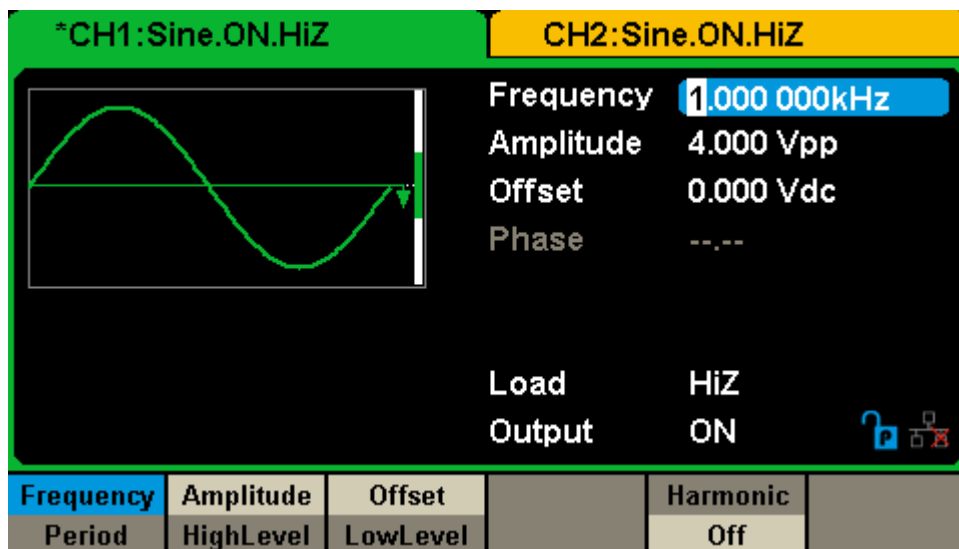

Figure 2-78 Independent Mode

## 2.13.10 Overvoltage Protection

Choose **Utility** → **Page 1/2** → **OverVoltage Protection** to turn on or off the function, as shown in the following figure.

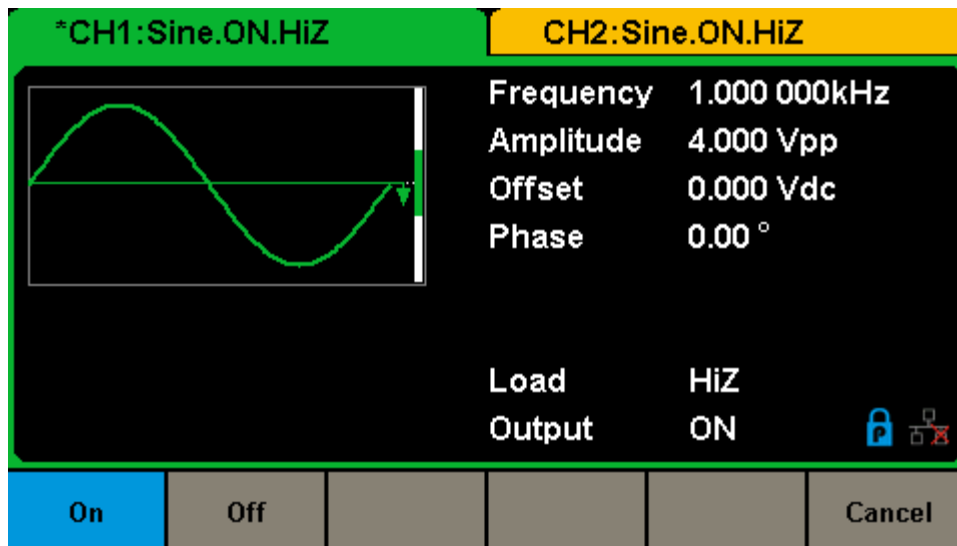

Figure 2-79 Overvoltage Protection Interface

If the state is set to ON, overvoltage protection of CH1 and CH2 will take effect once any of the following conditions is met. When overvoltage protection occurs, a message will be displayed and the output is disabled.

- The absolute value of input voltage is higher than  $11V \pm 0.5V$  when the amplitude of the generator is higher than or equal to  $3.2V_{pp}$  or the DC offset is higher than or equal to  $|2V_{DC}|$ .
- The absolute value of input voltage is higher than  $4V \pm 0.5V$  when the amplitude of the generator is lower than  $3.2V_{pp}$  or the DC offset is lower than  $|2V_{DC}|$ .

## 3 Examples

To help the user master how to use the SDG2000X more efficiently, we provide some examples in detail. All the examples below use the default setting of the instrument except in special cases.

This chapter includes the following topics:

- Example 1: Generate a Sine Waveform
- Example 2: Generate a Square Waveform
- Example 3: Generate a Ramp Waveform
- Example 4: Generate a Pulse Waveform
- Example 5: Generate a Noise
- Example 6: Generate a DC Waveform
- Example 7: Generate a Linear Sweep Waveform
- Example 8: Generate a Burst Waveform
- Example 9: Generate an AM Modulation Waveform
- Example 10: Generate a FM Modulation Waveform
- Example 11: Generate a PM Modulation Waveform
- Example 12: Generate a FSK Modulation Waveform
- Example 13: Generate an ASK Modulation Waveform
- Example 14: Generate a PSK Modulation Waveform
- Example 15: Generate a PWM Modulation Waveform
- Example 16: Generate a DSB-AM Modulation Waveform

### 3.1 Example 1: Generate a Sine Waveform

Generate a sine waveform with 1MHz frequency, 5Vpp amplitude and 1Vdc offset.

➤ **Steps:**

- Set the frequency.
  1. Press **Waveforms** → **Sine** → **Frequency/Period** and choose **Frequency** which will display in blue color.
  2. Input '1' from the keyboard and choose the unit 'MHz'. The frequency is set to 1MHz.
  
- Set the Amplitude.
  1. Press **Amplitude/HighLevel** to choose **Amplitude** which will display in blue color.
  2. Input '5' from the keyboard and choose the unit 'Vpp'. The amplitude is set to 5Vpp.
  
- Set the Offset.
  1. Press **Offset/LowLevel** to choose **Offset** which will display in blue color.
  2. Input '1' from the keyboard and choose the unit 'Vdc'. The offset is set to 1Vdc.

When the frequency, amplitude and offset are set, the waveform generated is shown in Figure 3-1.

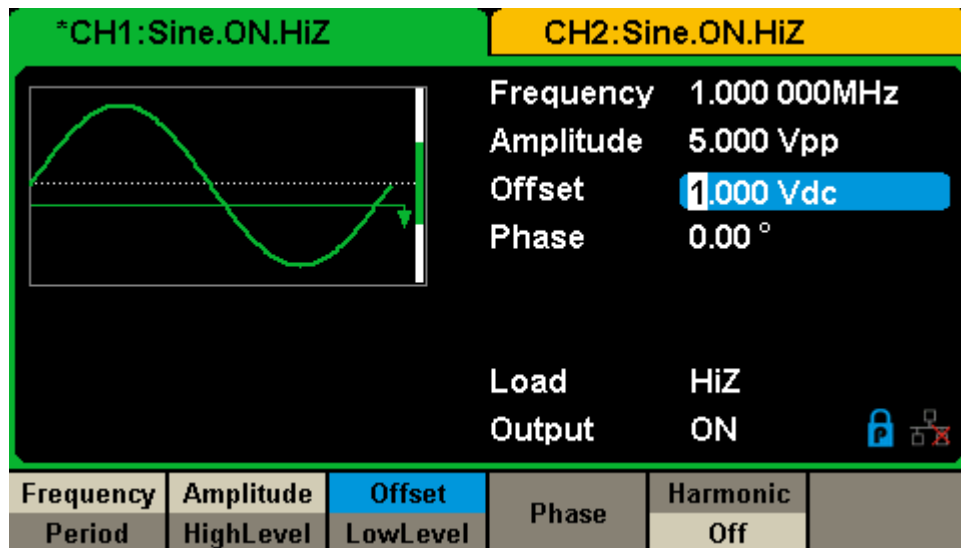

Figure 3-1 Generate a Sine Waveform

## 3.2 Example 2: Generate a Square Waveform

Generate a square waveform with 5kHz frequency, 2Vpp amplitude, 1Vdc offset and 30% duty cycle.

➤ **Steps:**

- Set the frequency.
  1. Press **Waveforms** → **Square** → **Frequency/Period** and choose **Frequency** which will display in blue color.
  2. Input '5' from the keyboard and choose the unit 'kHz'. The frequency is set to 5kHz.
  
- Set the Amplitude.
  1. Press **Amplitude/HighLevel** to choose **Amplitude** which will display in blue color.
  2. Input '2' from the keyboard and choose the unit 'Vpp'. The amplitude is set to 2Vpp.
  
- Set the Offset.
  1. Press **Offset/LowLevel** to choose **Offset** which will display in blue color.
  2. Input '1' from the keyboard and choose the unit 'Vdc'. The offset is set to 1Vdc.
  
- Set the DutyCycle.
  1. Press **DutyCycle** to choose **DutyCycle** which will display in blue color.
  2. Input '30' from the keyboard and choose the unit '%'. The duty is set to 30%.

When the frequency, amplitude, offset and duty cycle are set, the waveform generated is shown in Figure 3-2.

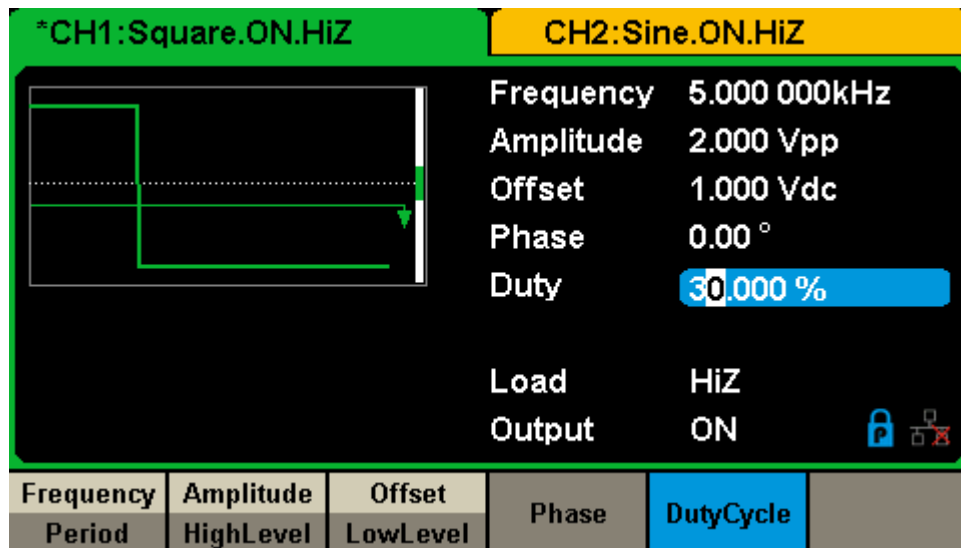

Figure 3-2 Generate a Square Waveform

### 3.3 Example 3: Generate a Ramp Waveform

Generate a ramp waveform with  $10\mu\text{s}$  period,  $100\text{mVpp}$  amplitude,  $20\text{mVdc}$  offset,  $45^\circ$  phase and 30% symmetry.

➤ **Steps:**

● Set the Period.

1. Press **Waveforms** → **Ramp** → **Frequency/Period** and choose **Period** which will display in blue color.
2. Input '10' from the keyboard and choose the unit ' $\mu\text{s}$ '. The period is set to  $10\mu\text{s}$ .

● Set the Amplitude.

1. Press **Amplitude/HighLevel** to choose **Amplitude** which will display in blue color.
2. Input '100' from the keyboard and choose the unit ' $\text{mVpp}$ '. The amplitude is set to  $100\text{mVpp}$ .

● Set the Offset.

1. Press **Offset/LowLevel** to choose **Offset** which will display in blue color.
2. Input '20' from the keyboard and choose the unit ' $\text{mVdc}$ '. The offset is set to  $20\text{mVdc}$ .

● Set the Phase.

1. Press **Phase** to choose **Phase** which will display in blue color.
2. Input '45' from the keyboard and choose the unit ' $^\circ$ '. The phase is set to  $45^\circ$ .

● Set the Symmetry.

1. Press **Symmetry** to choose **Symmetry** which will display in blue color.
2. Input '30' from the keyboard and choose the unit '30%'. The symmetry is set to 30%.



When the period, amplitude, offset, phase and symmetry are set, the waveform generated is shown in Figure 3-3.

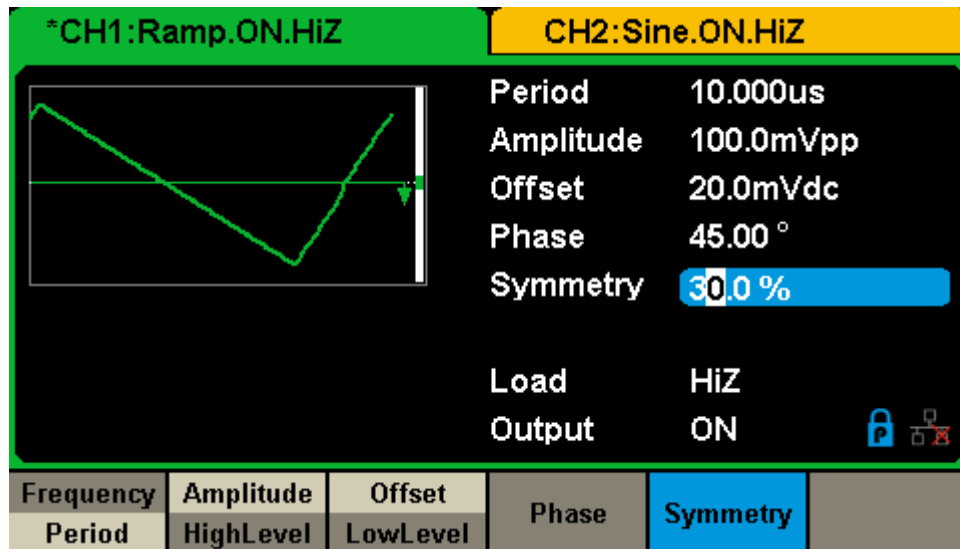

Figure 3-3 Generate a Ramp Waveform

### 3.4 Example 4: Generate a Pulse Waveform

Generate a pulse waveform with 5kHz frequency, 5V high level, -1V low level, 40 $\mu$ s pulse width and 20ns delay.

➤ **Steps:**

● Set the Frequency.

1. Press **Waveforms** → **Pulse** → **Frequency/Period** and choose **Frequency**, which will display in blue color.
2. Input '5' from the keyboard and choose the unit 'kHz'. The frequency is set to 5 kHz.

● Set the HighLevel.

1. Press **Amplitude/HighLevel** and choose the **HighLevel** which will display in blue color.
2. Input '5' from the keyboard and choose the unit 'V'. The high level is set to 5V.

● Set the LowLevel.

1. Press **Offset/LowLevel** and choose the **LowLevel** which will display in blue color.
2. Input '-1' from the keyboard and choose the unit 'V'. The low level is set to -1V.

● Set the PulWidth.

1. Press **PulWidth/DutyCycle** and choose **PulWidth** which will display in blue color.
2. Input '40' from the keyboard and choose the unit ' $\mu$ s'. The pulse width is set to 40 $\mu$ s.

● Set the Delay.

1. Press **Delay** to choose **Delay** which will display in blue color.

- Input '20' from the keyboard and choose the unit 'ns'. The delay is set to 20ns.

When the frequency, high level, low level, pulse width and delay are set, the waveform generated is shown in Figure 3-4.

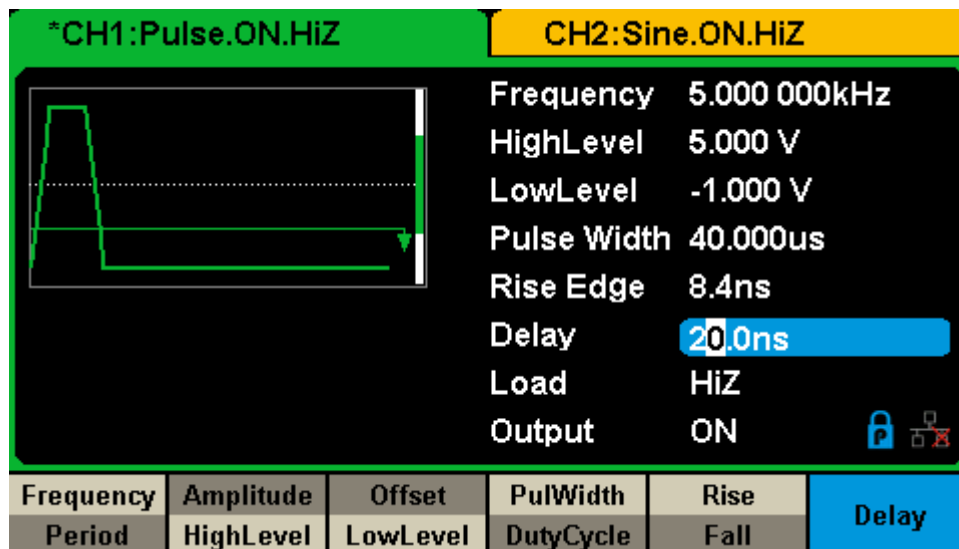

Figure 3-4 Generate a Pulse Waveform

### 3.5 Example 5: Generate a Noise

Generate a noise with 0.5V stdev and 1 V mean.

➤ **Steps:**

● Set the Stdev.

1. Press **Waveforms** → **Noise** → **Stdev** to choose **Stdev** which will display in blue color.
2. Input '0.5' from the keyboard and choose the unit 'V'. The stdev is set to 0.5 V.

● Set the Mean.

1. Press **Mean** to choose **Mean** which will display in blue color.
2. Input '1' from the keyboard and choose the unit 'V'. The mean is set to 1V.

When the stdev and mean are set, the noise generated is shown in Figure 3-5.

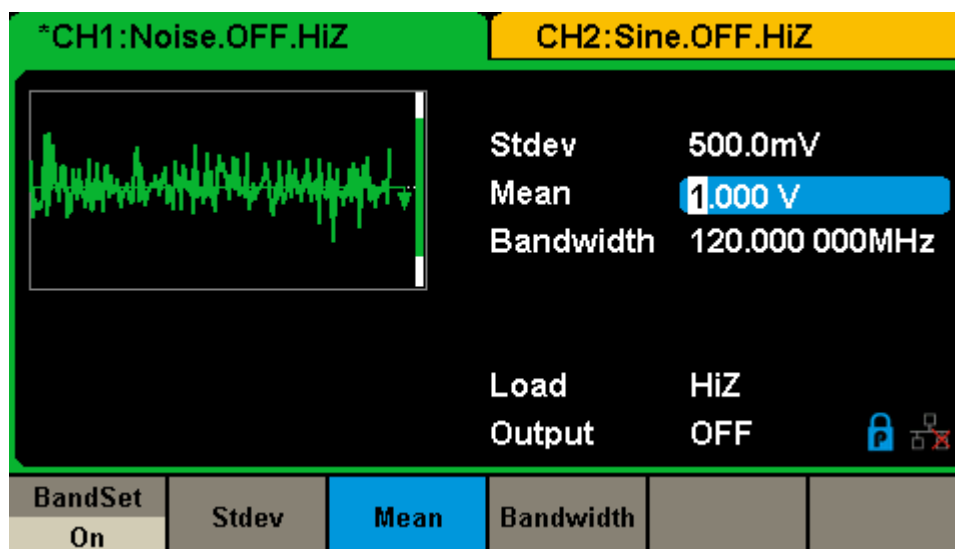

Figure 3-5 Generate a Noise

### 3.6 Example 6: Generate a DC Waveform

Generate a DC waveform with 3Vdc offset,

➤ **Steps:**

- Choose the DC waveform.
  1. Press **Waveforms** → **Page 1/2** → **DC**, to choose the DC waveform.
- Set the Offset.
  1. Press **Offset** and choose **Offset** which will display in blue color.
  2. Input '3' from the keyboard and choose the unit 'Vdc'. The DC offset is set to 3Vdc.

When the DC offset is set, the waveform generated is shown in Figure 3-6.

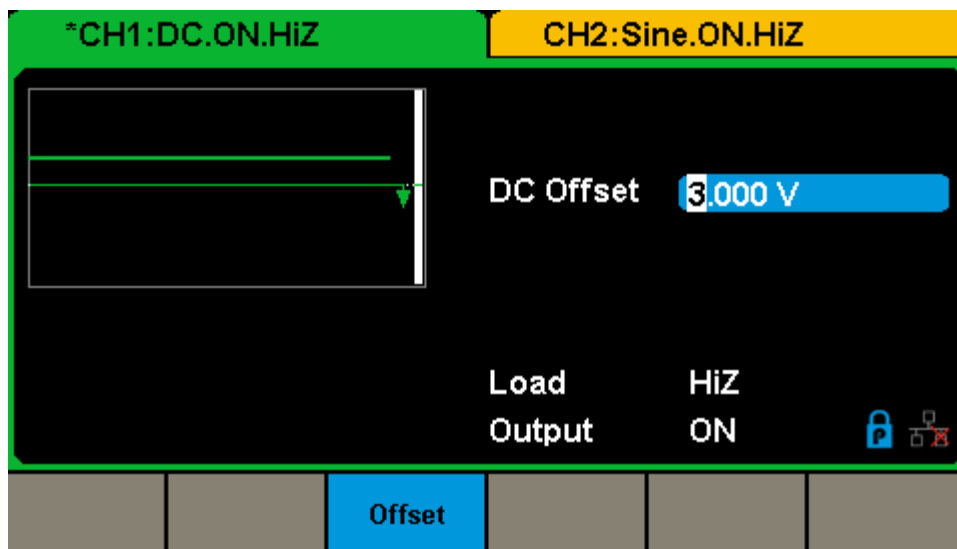

Figure 3-6 Generate a DC Waveform

### 3.7 Example7: Generate a Linear Sweep Waveform

Generate a sine sweep waveform whose frequency starts at 100Hz and sweeps to a frequency of 10KHz. Use internal trigger mode, linear sweep, and a sweep time of 2s.

➤ **Steps:**

- Set the sweep function.  
Press **Waveforms** and choose the sine waveform as the sweep function.  
The default setting of the source is internal.
  
- Set the amplitude and offset.
  1. Press **Amplitude/HighLevel** to choose **Amplitude** which will display in blue color. Input '5' from the keyboard and choose the unit 'Vpp' to set the amplitude to 5Vpp.
  2. Press **Offset/LowLevel** to choose **Offset** which will display in blue color. Input '0' from the keyboard and choose the unit 'Vdc' to set the offset to 0Vdc
  
- Set the sweep time.  
Press **Sweep** → **Page 1/2** → **Sweep Time**, input '1' from the keyboard and choose the unit 's' to set the sweep time to 1s.
  
- Set the start frequency.  
Press **StartFreq**, input '100' from the keyboard and choose the unit 'Hz' to set the start freq to 100Hz.
  
- Set the stop frequency.  
Press **StopFreq**, input '10' from the keyboard and choose the unit 'kHz' to set the stop freq to 10kHz.
  
- Set the sweep profiles.

Press **Type** and choose **Linear**.

When all parameters above are set, the linear sweep waveform generated is shown in Figure 3-7.

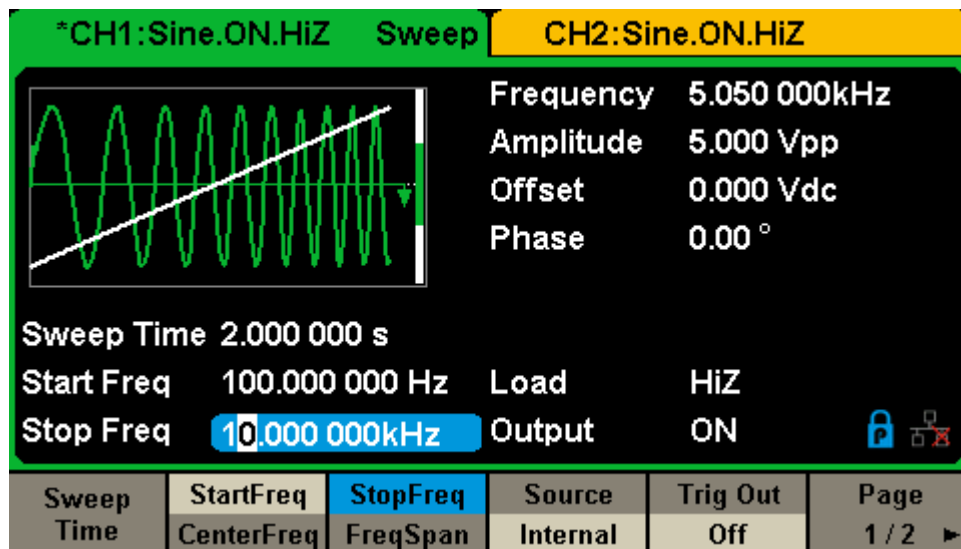

Figure 3-7 Generate a Linear Sweep Waveform

### 3.8 Example 8: Generate a Burst Waveform

Generate a burst waveform with 5 cycles. The burst period is 3ms. Use internal trigger and 0° start phase.

➤ **Steps:**

- Set the burst function.  
Press **Waveforms**, and choose the sine waveform as the burst function.
- Set the frequency, amplitude and offset.
  1. Press **Frequency/Period** and choose **Frequency** which will display in blue color. Input '10' from the keyboard and choose the unit 'kHz' to set the frequency to 10kHz.
  2. Press **Amplitude/HighLevel** to choose **Amplitude** which will display in blue color. Input '4' from the keyboard and choose the unit 'Vpp' to set the amplitude to 4Vpp.
  3. Press **Offset/LowLevel** to choose **Offset** which will display in blue color. Input '0' from the keyboard and choose the unit 'Vdc' to set the offset to 0Vdc
- Set the burst mode.  
Press **Burst** → **NCycle**, choose N-Cycle Mode. The default setting of the source is internal.
- Set the burst period.  
Press **Burst Period**, input '3' from the keyboard and choose the unit 'ms' to set the burst period to 3ms.
- Set the start phase.  
Press **Start Phase**, input '0' from the keyboard and choose the unit '°' to set the start phase to 0°.



- Set the burst cycle.  
Press **Cycle**, Input '5' from the keyboard and choose the unit 'Cycle' to set the burst cycle count to 5.
- Set the delay.  
Press **Page 1/2** to choose **Delay**, and input '100' from the keyboard and choose the unit 'μs' to set the delay to 100μs.

When all parameters above are set, the waveform generated is shown in Figure 3-8.

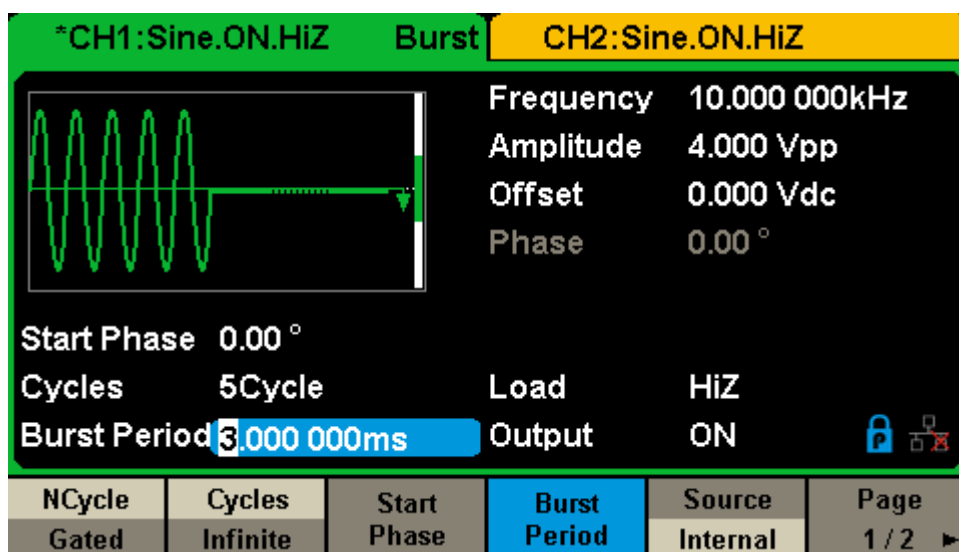

Figure 3-8 Generate a N-Cycle Burst Waveform

### 3.9 Example 9: Generate an AM Modulation Waveform

Generate an AM modulation waveform with 80% depth. The carrier is a sine wave with 10kHz frequency, and the modulating wave is a sine wave with 200Hz frequency.

➤ **Steps:**

- Set the frequency, amplitude and offset of the carrier wave.
  1. Press **Waveforms**, and choose the sine waveform as the carrier wave
  2. Press **Frequency/Period** and choose **Frequency** which will display in blue color. Input '10' from the keyboard and choose the unit 'kHz' to set the frequency to 10kHz
  3. Press **Amplitude/HighLevel** and choose **Amplitude** which will display in blue color. Input '1' from the keyboard and choose the unit 'Vpp' to set the amplitude to 1Vpp.
  4. Press **Offset/LowLevel** and choose **Offset** which will display in blue color. Input '0' from the keyboard and choose the unit 'Vdc' to set the offset to 0Vdc.
  
- Set the modulation type AM and parameters.
  1. Press **Mod** → **Type** → **AM**, choose AM. Please notice that the message shown on the middle left side of the screen is 'AM'.
  2. Press **AM Freq**, input '200' from the keyboard and choose the unit 'Hz' to set the AM Freq to 200Hz.
  3. Press **AM Depth**, input '80' from the keyboard and choose the unit '%' to set the AM depth to 80%.
  4. Press **Shape** → **Sine**, to choose sine wave as the modulating waveform.

When all parameters above are set, the waveform generated is shown in Figure 3-9.

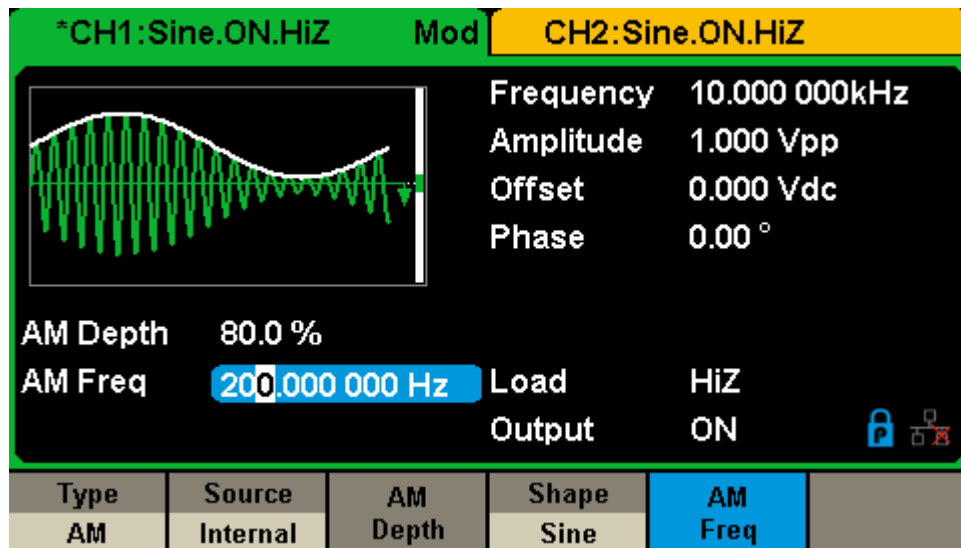

Figure 3-9 Generate an AM Modulation Waveform

### 3.10 Example 10: Generate a FM Modulation Waveform

Generate a FM modulation waveform, the carrier is a sine wave with 10kHz frequency, and the modulating wave is a sine wave with 1Hz frequency and 2kHz frequency deviation.

➤ **Steps:**

- Set the frequency, amplitude and offset of the carrier wave.
  1. Press **Waveforms**, and choose the sine waveform as the carrier wave.
  2. Press **Frequency/Period** and choose **Frequency** which will display in blue color. Input '10' from the keyboard and choose the unit 'kHz' to set the frequency to 10kHz
  3. Press **Amplitude/HighLevel** and choose **Amplitude** which will display in blue color. Input '1' from the keyboard and choose the unit 'Vpp' to set the amplitude to 1Vpp.
  4. Press **Offset/LowLevel** and choose **Offset** which will display in blue color. Input '0' from the keyboard and choose the unit 'Vdc' to set the offset to 0Vdc.
  
- Set the modulation type FM and parameters.
  1. Press **Mod** → **Type** → **FM**, choose FM. Please notice that the message shown on the middle left side of the screen is 'FM'.
  2. Press **FM Freq**, input '1' from the keyboard and choose the unit 'Hz' to set the FM Freq to 1Hz.
  3. Press **FM Dev**, input '2' from the keyboard and choose the unit 'kHz' to set the FM deviation to 2kHz.
  4. Press **Shape** → **Sine**, to choose sine wave as the modulating waveform.

When all parameters above are set, the waveform generated is shown in Figure 3-10.

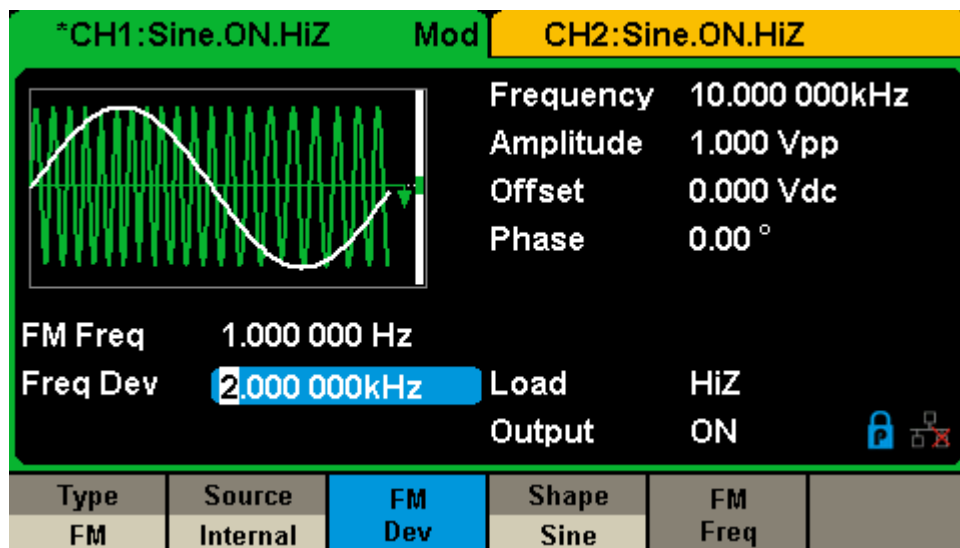

Figure 3-10 Generate a FM Modulation Waveform

### 3.11 Example 11: Generate a PM Modulation Waveform

Generate a PM modulation waveform, the carrier is a sine wave with 10kHz frequency, and the modulating wave is a sine wave with 2kHz frequency and 90° phase deviation.

➤ **Steps:**

- Set the frequency, amplitude and offset of the carrier wave.
  1. Press **Waveforms**, and choose the sine waveform as the carrier wave.
  2. Press **Frequency/Period** and choose **Frequency** which will display in blue color. Input '10' from the keyboard and choose the unit 'kHz' to set the frequency to 10kHz
  3. Press **Amplitude/HighLevel** and choose **Amplitude** which will display in blue color. Input '5' from the keyboard and choose the unit 'Vpp' to set the amplitude to 5Vpp.
  4. Press **Offset/LowLevel** and choose **Offset** which will display in blue color. Input '0' from the keyboard and choose the unit 'Vdc' to set the offset to 0Vdc.
  
- Set the modulation type PM and parameters.
  1. Press **Mod** → **Type** → **PM**, choose PM. Please notice that the message shown on the middle left side of the screen is 'PM'.
  2. Press **PM Freq**, input '2' from the keyboard and choose the unit 'kHz' to set the PM Freq to 2kHz.
  3. Press **Phase Dev**, input '90' from the keyboard and choose the unit ' ° ' to set the phase deviation to 90°.
  4. Press **Shape** → **Sine**, to choose sine wave as the modulating waveform.

When all parameters above are set, the waveform generated is shown in Figure 3-11.

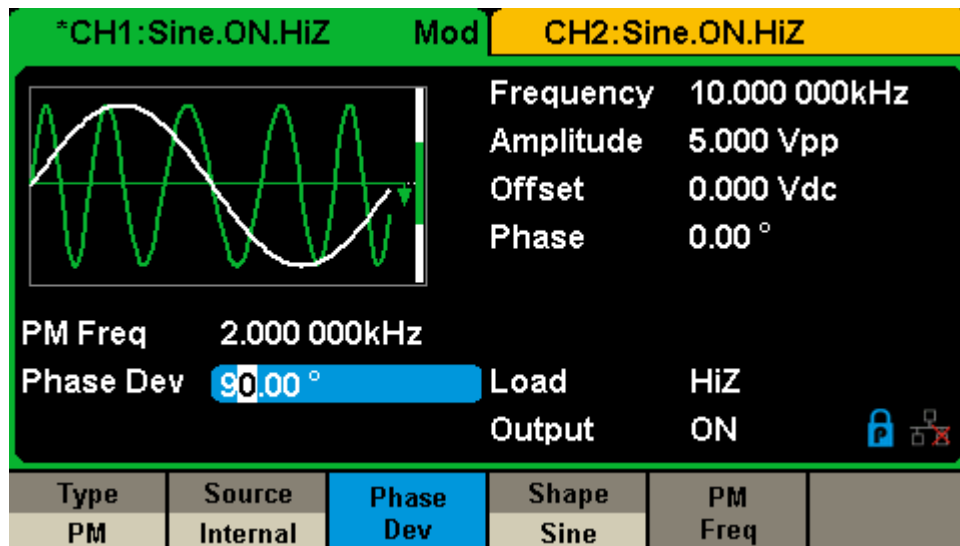

Figure 3-11 Generate a PM Modulation Waveform

## 3.12 Example 12: Generate a FSK Modulation Waveform

Generate a FSK modulation waveform with 200Hz key frequency. The carrier is a sine wave with 10kHz frequency, and the hop frequency is 500Hz.

### ➤ Steps:

- Set the frequency, amplitude and offset of the carrier wave.
  1. Press **Waveforms**, and choose the sine waveform as the carrier wave
  2. Press **Frequency/Period** and choose **Frequency** which will display in blue color. Input '10' from the keyboard and choose the unit 'kHz' to set the frequency to 10kHz.
  3. Press **Amplitude/HighLevel** and choose **Amplitude** which will display in blue color. Input '5' from the keyboard and choose the unit 'Vpp' to set the amplitude to 5Vpp.
  4. Press **Offset/LowLevel** and choose **Offset** which will display in blue color. Input '0' from the keyboard and choose the unit 'Vdc' to set the offset to 0Vdc.
  
- Set the modulation type FSK and parameters.
  1. Press **Mod** → **Type** → **FSK**, choose FSK. Please notice that the message shown on the middle left side of the screen is 'FSK'.
  2. Press **Key Freq**, input '200' from the keyboard and choose the unit 'Hz' to set the key frequency to 200 Hz.
  3. Press **Hop Freq**, input '500' from the keyboard and choose the unit 'Hz' to set the hop frequency to 500Hz.

When all parameters above are set, the waveform generated is shown in Figure 3-12.



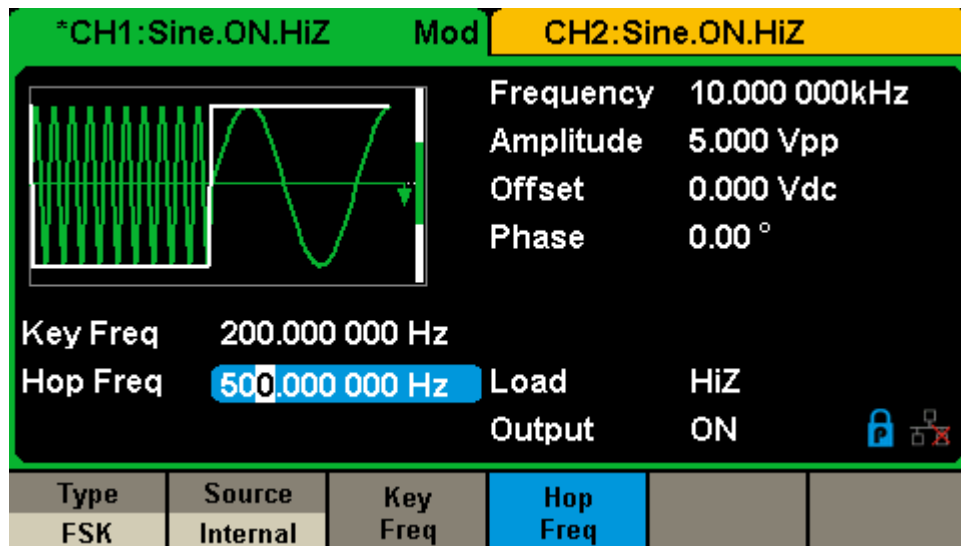

Figure 3-12 Generate a FSK Modulation Waveform

### 3.13 Example 13: Generate an ASK Modulation Waveform

Generate an ASK modulation waveform with 500Hz key frequency. The carrier is a sine wave with 5kHz frequency.

➤ **Steps:**

- Set the frequency, amplitude and offset of the carrier wave.
  1. Press **Waveforms**, and choose the sine waveform as the carrier wave
  2. Press **Frequency/Period** and choose **Frequency** which will display in blue color. Input '5' from the keyboard and choose the unit 'kHz' to set the frequency to 5kHz
  3. Press **Amplitude/HighLevel** and choose **Amplitude** which will display in blue color. Input '5' from the keyboard and choose the unit 'Vpp' to set the amplitude to 5Vpp.
  4. Press **Offset/LowLevel** and choose **Offset** which will display in blue color. Input '0' from the keyboard and choose the unit 'Vdc' to set the offset to 0Vdc.
  
- Set the modulation type ASK and parameters.
  1. Press **Mod** → **Type** → **ASK**, choose ASK. Please notice that the message shown on the middle left side of the screen is 'ASK'.
  2. Press **Key Freq**, input '500' from the keyboard and choose the unit 'Hz' to set the key frequency to 500 Hz.

When all parameters above are set, the waveform generated is shown in Figure 3-13

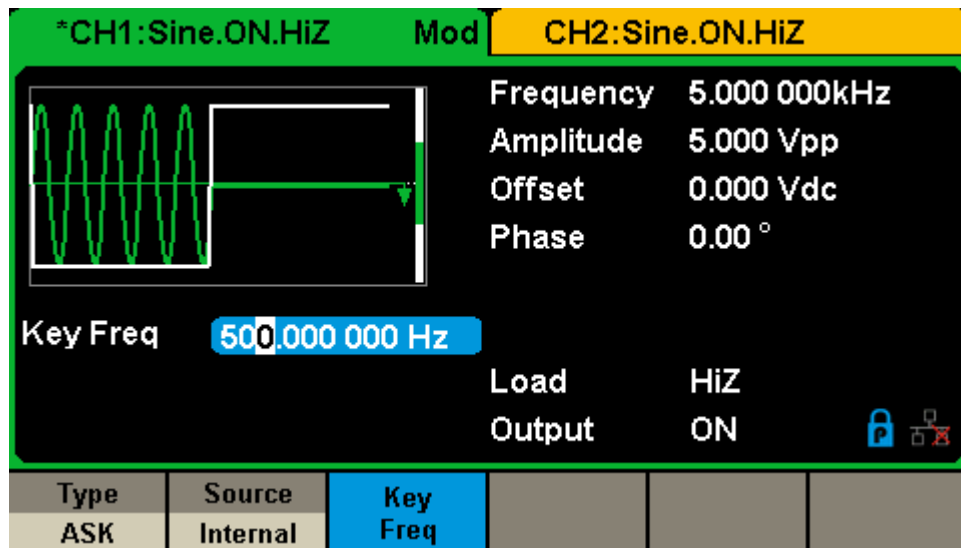

Figure 3-13 Generate an ASK Modulation Waveform

### 3.14 Example 14: Generate a PSK Modulation Waveform

Generate a PSK modulation waveform with 200Hz key frequency. The carrier is a sine wave with 1kHz frequency.

➤ **Steps:**

- Set the frequency, amplitude and offset of the carrier wave.
  1. Press **Waveforms**, and choose the sine waveform as the carrier wave
  2. Press **Frequency/Period** and choose **Frequency** which will display in blue color. Input '1' from the keyboard and choose the unit 'kHz' to set the frequency to 1kHz
  3. Press **Amplitude/HighLevel** and choose **Amplitude** which will display in blue color. Input '5' from the keyboard and choose the unit 'Vpp' to set the amplitude to 5Vpp.
  4. Press **Offset/LowLevel** and choose **Offset** which will display in blue color. Input '0' from the keyboard and choose the unit 'Vdc' to set the offset to 0Vdc.
  
- Set the modulation type PSK and parameters.
  1. Press **Mod** → **Type** → **Page 1/2** → **PSK**, choose PSK. Please notice that the message shown on the middle left side of the screen is 'PSK'.
  2. Press **Key Freq**, input '200' from the keyboard and choose the unit 'Hz' to set the key frequency to 200 Hz.
  3. Press **Polarity** → **Positive**.

When all parameters above are set, the waveform generated is shown in Figure 3-14.

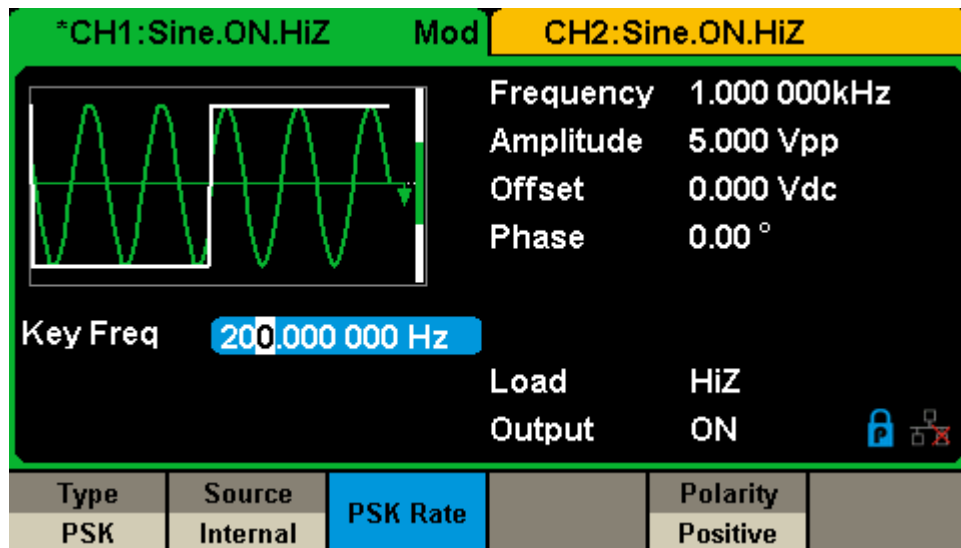

Figure 3-14 Generate a PSK Modulation Waveform

### 3.15 Example 15: Generate a PWM Modulation Waveform

Generate a PWM modulation waveform with 200Hz key frequency. The carrier is a pulse wave with 5kHz frequency.

➤ **Steps:**

- Set the frequency, amplitude and offset of the carrier wave.
  1. Press **Waveforms**, and choose the Pulse waveform as the carrier wave
  2. Press **Frequency/Period** and choose **Frequency** which will display in blue color. Input '5' from the keyboard and choose the unit 'kHz' to set the frequency to 5kHz
  3. Press **Amplitude/HighLevel** and choose **Amplitude** which will display in blue color. Input '5' from the keyboard and choose the unit 'Vpp' to set the amplitude to 5Vpp.
  4. Press **Offset/LowLevel** and choose **Offset** which will display in blue color. Input '0' from the keyboard and choose the unit 'Vdc' to set the offset to 0Vdc.
  5. Press **PulWidth/DutyCycle** and choose **PuWidth** which will display in blue color. Input '40' from the keyboard and choose the unit 'us' to set the PulWidth to 40us
  
- Set the modulation type PWM and parameters.
  1. Press **Mod**, Please notice that the message shown on the middle left side of the screen is 'PWM'.
  2. Press **PWM Freq**, input '200' from the keyboard and choose the unit 'Hz' to set the PWM Freq to 200Hz.
  3. Press **Width Dev**, input '20' from the keyboard and choose the unit 'us' to set the width deviation to 20us

When all parameters above are set, the waveform generated is shown in **Figure 3-15**.

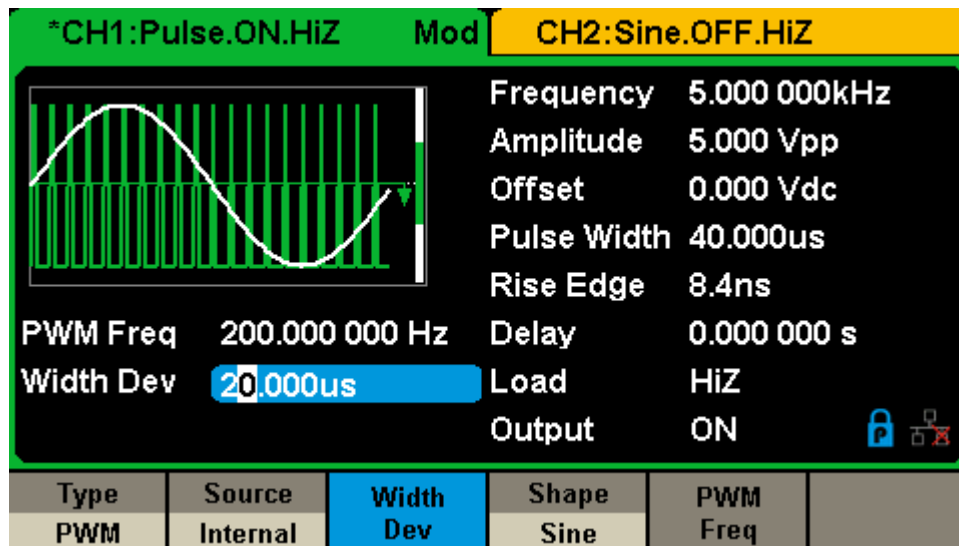

Figure 3-15 Generate a PWM Modulation Waveform

### 3.16 Example 16: Generate a DSB-AM Modulation Waveform

Generate a DSB-AM modulation waveform with 100Hz modulating frequency. The carrier is a sine wave with 2kHz frequency.

➤ **Steps:**

- Set the frequency, amplitude and offset of the carrier wave.
  1. Press **Waveforms**, and choose the sine waveform as the carrier wave.
  2. Press **Frequency/Period** and choose **Frequency** which will display in blue color. Input '2' from the keyboard and choose the unit 'kHz' to set the frequency to 2kHz
  3. Press **Amplitude/HighLevel** and choose **Amplitude** which will display in blue color. Input '4' from the keyboard and choose the unit 'Vpp' to set the amplitude to 4Vpp.
  4. Press **Offset/LowLevel** and choose **Offset** which will display in blue color. Input '0' from the keyboard and choose the unit 'Vdc' to set the offset to 0Vdc.
  
- Set the modulation type DSB-AM and parameters.
  1. Press **Mod** → **Type** → **DSB-AM**, choose DSB-AM. Please notice that the message shown on the middle left side of the screen is 'DSB-AM'.
  2. Press **DSB Freq**, input '100' from the keyboard and choose the unit 'Hz' to set the DSB Freq to 100Hz.

When all parameters above are set, the waveform generated is shown in Figure 3-16.



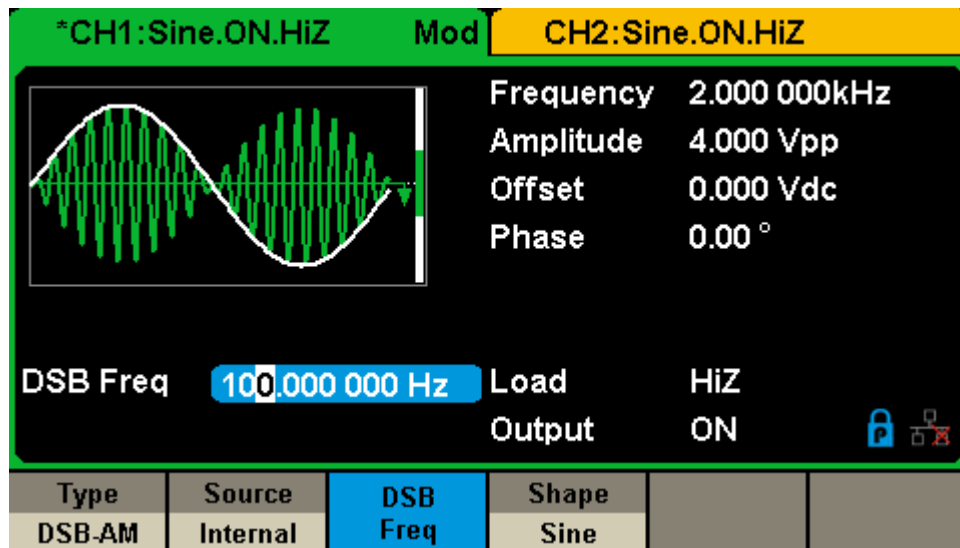

Figure 3-16 Generate a DSB-AM Modulation Waveform

## 4 Troubleshooting

### 4.1 General Inspecting

After receiving a new SDG2000X Series Function/Arbitrary Generator please inspect the instrument as followed:

**1. Inspect the shipping container for damage.**

Keep the damaged shipping container or cushioning material until the contents of the shipment have been checked for completeness and the instrument has been checked mechanically and electrically.

**2. Inspect the entire instrument.**

In case there is any mechanical damage or defect, or the instrument does not operate properly or fails in the performance tests, notify the SIGLENT sales representative.

If the shipping container is damaged, or the cushioning materials show signs of stress, notify the carrier as well as the SIGLENT sales department. Keep the shipping materials for carrier's inspection.

**3. Check the accessories.**

Accessories supplied with the instrument are listed in "**Appendix A**". If the contents are incomplete or damaged, notify the SIGLENT sales representative.

## 4.2 Troubleshooting

**1. After the generator is powered on, if the screen remains dark please do as the following steps:**

- (1) Check the power cable's connection.
- (2) Ensure the power switch is turned on.
- (3) After the inspections above, restart the generator.
- (4) If the generator still doesn't work after checking, please contact SIGLENT.

**2. If there is no waveform output after setting the parameters, please do as the following steps:**

- (1) Check whether the BNC cable has a good connection to the output port.
- (2) Check whether the output keys have been turned on.
- (3) If the generator still doesn't work after checking, please contact SIGLENT.

## 5 Service and Support

### 5.1 Maintenance summary

**SIGLENT** warrants that the products it manufactures and sells will be free from defects in materials and workmanship for three years from the date of shipment from an authorized **SIGLENT** distributor. If a product is proved to be defective within the warranty period, **SIGLENT** will provide repair or replace the unit as described in the complete warranty statement.

To arrange for service or obtain a copy of the complete warranty statement, please contact your nearest **SIGLENT** sales and service office. Except as provided in this summary or the applicable warranty statement, **SIGLENT** makes no warranty of any kind, express or implied, including but not limited to the implied warranties of merchantability and special applicability. In no event shall **SIGLENT** be liable for indirect, special or consequential damages.

## 5.2 Contact SIGLENT

SIGLENT TECHNOLOGIES CO., LTD

Address: 3/F, NO.4 building, Antongda Industrial Zone, 3rd Liuxian Road, 68th

District, Baoan District, Shenzhen, P.R. China

Tel: 400-878-0807

E-mail: [sales@siglent.com](mailto:sales@siglent.com)

<http://www.siglent.com>

## 6 Appendix

### Appendix A: Accessories

#### SDG2000X Series Function/Arbitrary Waveform Generator Accessories:

##### Standard Accessories:

- Quick Start Guide
- A Calibration Report
- A Power cord that fits the standard of the destination country
- A USB Cable
- A BNC Coaxial Cable

##### Optional Accessories:

- USB-GPIB adapter (IEEE 488.2)
- SPA1010 Power Amplifier
- 20dB Attenuator

## Appendix B: Daily Maintenance and Cleaning

### Daily Maintenance

Do not store or leave the instrument in where the display screen will be exposed to direct sunlight for a long period of time.



**CAUTION:** To avoid damage to the instrument, do not expose it to spray, liquid, or solvent.

---

### Cleaning

If the instrument requires cleaning, disconnect it from all power sources and clean it with a mild detergent and water. Make sure the instrument is completely dry before reconnecting it to a power source.

To clean the exterior surface, perform the following steps:

1. Remove loose dust on the outside of the instrument with a lint-free cloth. When cleaning the touch screen, be careful to avoid scratching the transparent plastic protective screen.
2. Use a soft cloth dampened with water to clean the instrument.



**WARNING:** To avoid any damage to the surface of the instrument, do not use any abrasive or chemical cleaning agents.

---

## **Nettoyage**

Si l'instrument exige le nettoyage, démontez-le de toutes les sources d'énergie et nettoyez-le avec un détergent doux et arrosez. Assurez-vous que l'instrument est complètement sec avant de le rebrancher à une source d'énergie.

Pour nettoyer la surface extérieure, exécutez les étapes suivantes :

1. Enlevez la poussière lâche sur l'extérieur de l'instrument avec un tissu non pelucheux. When cleaning the touch screen, be careful to avoid scratching the transparent plastic protective screen.
2. Use a soft cloth dampened with water to clean the instrument.

---

**AVERTISSEMENT:** Pour n'éviter aucun d'endommager la surface de l'instrument, n'employez aucun produit d'épuration abrasif ou chimérique.

---

