



# SSA3000X Spectrum Analyzer

## Programming Guide

PG0703X-E04A



## Contents

<b>1.</b>	<b>Programming Overview .....</b>	<b>3</b>
1.1	Remotely Operating the Analyzer .....	3
1.2	Build Communication .....	4
1.3	Remote Control Capabilities .....	7
<b>2.</b>	<b>SCPI Overview .....</b>	<b>11</b>
2.1	Command Format.....	11
2.2	Symbol Instruction.....	11
2.3	Parameter Type.....	12
2.4	Command Abbreviation .....	13
<b>3.</b>	<b>System Commands .....</b>	<b>14</b>
3.1	IEEE Common Commands .....	14
3.2	System Subsystem .....	16
3.3	Instrument Subsystem.....	21
3.4	Initiate Subsystem.....	22
3.5	Sense Subsystem.....	23
3.6	Calculate Subsystem .....	41
3.7	Measurement Subsystem .....	58
3.8	Trigger Subsystem .....	67
3.9	TG Subsystem .....	68
3.10	Demod Subsystem .....	70
3.11	Calibration Subsystem .....	71
3.12	Memory Subsystem .....	72
<b>4.</b>	<b>Programming Examples .....</b>	<b>73</b>
4.1	Examples of Using VISA.....	73
4.2	Examples of Using Sockets/Telnet .....	84

# 1. Programming Overview

SSA3000X Series Spectrum Analyzer support LAN, USB Device, and GPIB--USB Host interfaces. By using these interfaces, in combination with programming languages and/or NI-VISA software, users can remotely control the analyzer based on SCPI (Standard Commands for Programmable Instruments) command set, and interoperate with other programmable instruments.

This chapter introduces how to build communication between the spectrum analyzer and a controller computer with these interfaces.

## 1.1 Remotely Operating the Analyzer

The analyzer provides both the USB and LAN connection which allows you to set up a remote operation environment with a controller computer. A controller computer could be a personal computer (PC) or a minicomputer. Some intelligent instruments also function as controllers.

### 1.1.1 Connecting the Analyzer via the USB Device port

Refer to the following steps to finish the connection via USB-Device:

1. Install NI-VISA on your PC for USB-TMC driver.
2. Connect the analyzer USB Device port to a PC with a USB A-B cable.



3. Switch on the analyzer

The analyzer will be detected automatically as a new USB hardware.

### 1.1.2 Connecting the Analyzer via the LAN port

Refer to the following steps to finish the connection via LAN:

1. Install NI-VISA on your PC for VXI driver. Or without NI-VISA, using socket or telnet in your PC's Operating System.
2. Connect the analyzer to PC or the local area network with a LAN cable



3. Switch on the analyzer

4. Press button on the front panel **System** → Interface → LAN to enter the LAN Config function menu.
5. Select the IP Config between Static and DHCP
  - ◆ DHCP: the DHCP server in the current network will assign the network parameters automatically (IP address, subnet mask, gate way) for the analyzer.
  - ◆ Static: you can set the IP address, subnet mask, gate way manually. Press Apply.

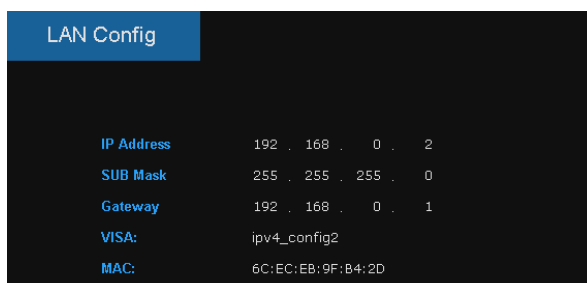

The analyzer will be detected automatically or manually as a new LAN point.

### 1.1.3 Connecting the Analyzer via the USB-Host port (With USB-GPIB Adaptor)

Refer to the following steps to finish the connection via USB:

1. Install NI-VISA on your PC for GPIB driver.
2. Connect the analyzer USB Host port to a PC's GPIB card port, with SIGLENT USB-GPIB adaptor.



3. Switch on the analyzer
4. Press button on the front panel **System** → Interface → GPIB to enter the GPIB number.

The analyzer will be detected automatically as a new GPIB point.

## 1.2 Build Communication

### 1.2.1 Build Communication Using VISA

NI-VISA includes a Run-Time Engine version and a Full version. The Run-Time Engine version provides NI device drivers such as USB-TMC, VXI, GPIB, etc. The full version includes the Run-Time Engine and a software tool named NI MAX that provides a user interface to control the device.

You can get NI-VISA full version from:

<http://www.ni.com/download/>.

After download you can follow the steps below to install it:

a. Double click the visa\_full.exe, dialog shown as below:

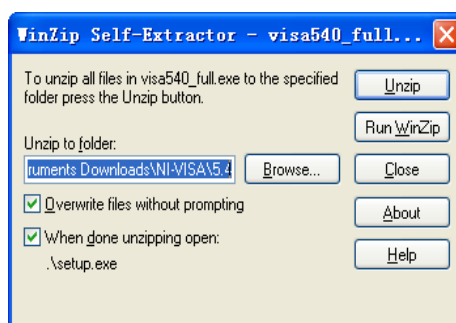

b. Click Unzip, the installation process will automatically launch after unzipping files. If your computer needs to install .NET Framework 4, its setup process will auto start.



c. The NI-VISA installing dialog is shown above. Click Next to start the installation process.

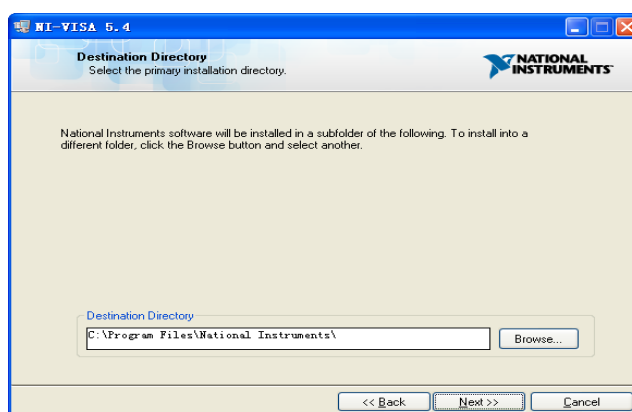

Set the install path, default path is "C:\Program Files\National Instruments\" , you can change it. Click Next, dialog shown as above.

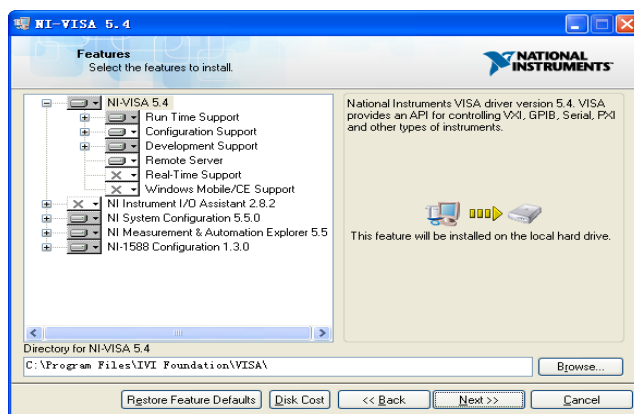

d. Click Next twice, in the License Agreement dialog, select the “ I accept the above 2 License Agreement(s).” ,and click Next, dialog shown as below:

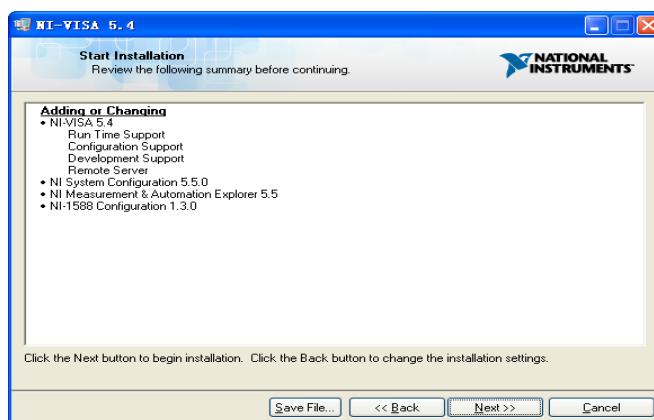

e. Click Next to run installation.

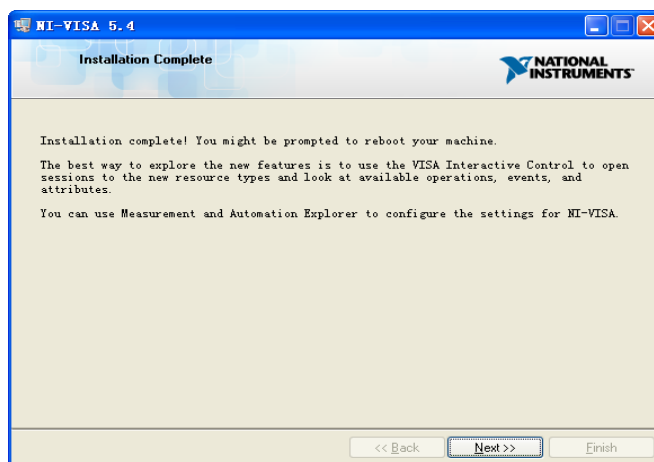

Now the installation is complete, reboot your PC.

## 1.2.2 Build Communication Using Sockets/Telnet

Through LAN interface, VXI-11, Sockets and Telnet protocols can be used to communicate with the spectrum analyzer. VXI-11 is provided in NI-VISA, while Sockets and Telnet are

commonly included in PC's OS initially.

Sockets LAN is a method used to communicate with the spectrum analyzer over the LAN interface using the Transmission Control Protocol/Internet Protocol (TCP/IP). A socket is a fundamental technology used for computer networking and allows applications to communicate using standard mechanisms built into network hardware and operating systems. The method accesses a port on the spectrum analyzer from which bidirectional communication with a network computer can be established.

Before you can use sockets LAN, you must select the analyzer's sockets port number to use:

- ◆ Standard mode. Available on port 5025. Use this port for programming.
- ◆ Telnet mode. The telnet SCPI service is available on port 5024.

## 1.3 Remote Control Capabilities

### 1.3.1 User-defined Programming

Users can use SCPI commands to program and control the spectrum analyzer. For details, refer to the introductions in “**Programming Examples**”.

### 1.3.2 Send SCPI Commands via NI MAX

Users can control the spectrum analyzer remotely by sending SCPI commands via NI-MAX software.

#### 1.3.2.1 Using USB

Run NI MAX software.

- 1, Click “Device and interface” at the upper left corner of the software;
- 2, Find the “USBTMC” device symbol

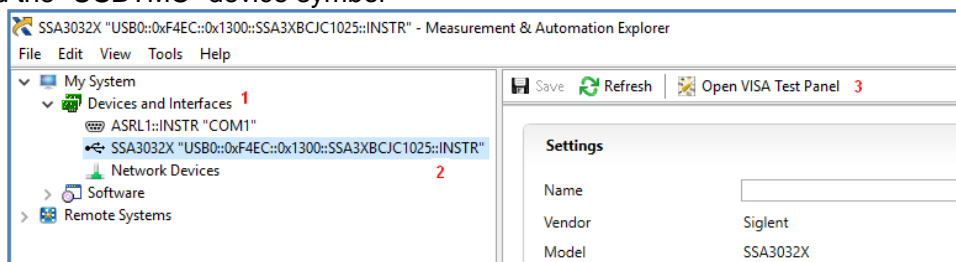

- 3, Click “Open VISA Test Panel” option button, then the following interface will appear.
- 4, Click the “Input/Output” option button and click the “Query” option button in order to view the operation information.

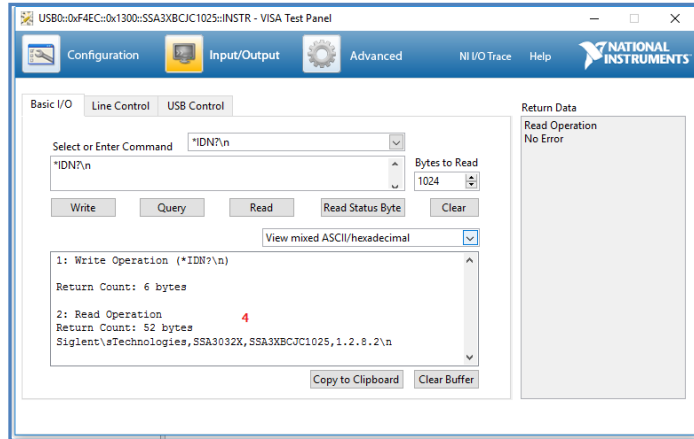

**NOTE:** The \*IDN? command (known as the Identification Query) returns the instrument manufacturer, instrument model, serial number, and other identification information.

### 1.3.2.2 Using LAN

select, Add Network Device, and select VISA TCP/IP Resource as shown:.

Run NI MAX software.

- 1, Click “Device and interface” at the upper left corner of the software;
- 2, Find the “Network Devices” symbol , click “Add Network Devices”;

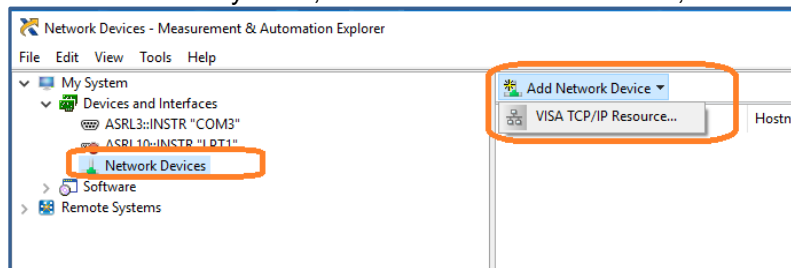

3. Select Manual Entry of LAN instrument, select Next, and enter the IP address as shown. Click Finish to establish the connection:

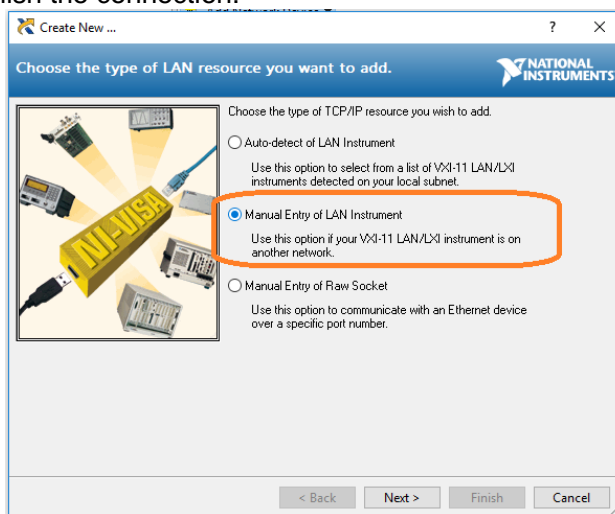

**NOTE:** Leave the LAN Device Name BLANK or the connection will fail.



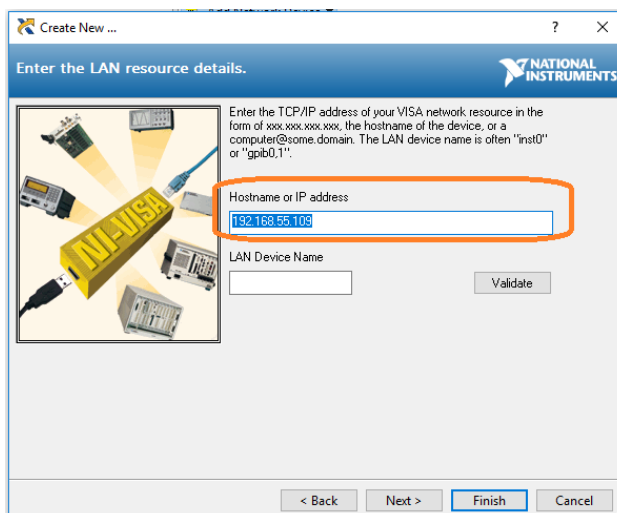

4. After a brief scan, the connection should be shown under Network Devices:

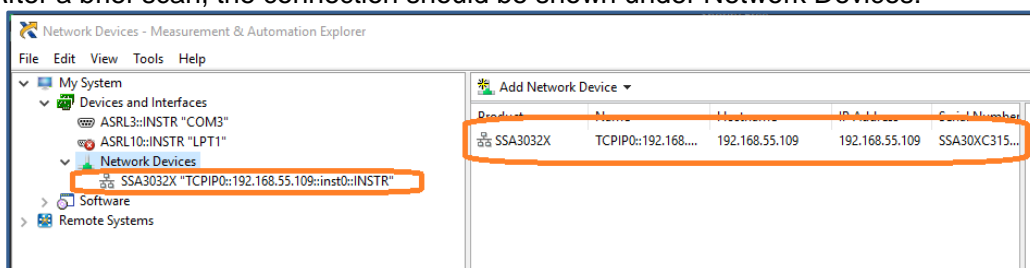

5. Right-click on the product and select Open NI-VISA Test Panel:

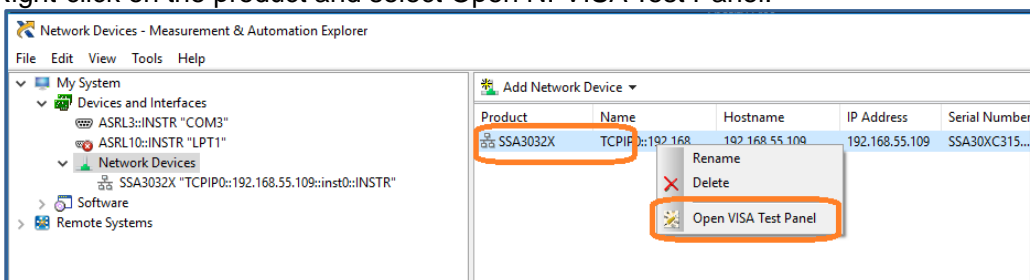

6. Click "Input/Output" option button and click "Query" option button. If everything is OK, you will see the Read operation information returned as shown below.

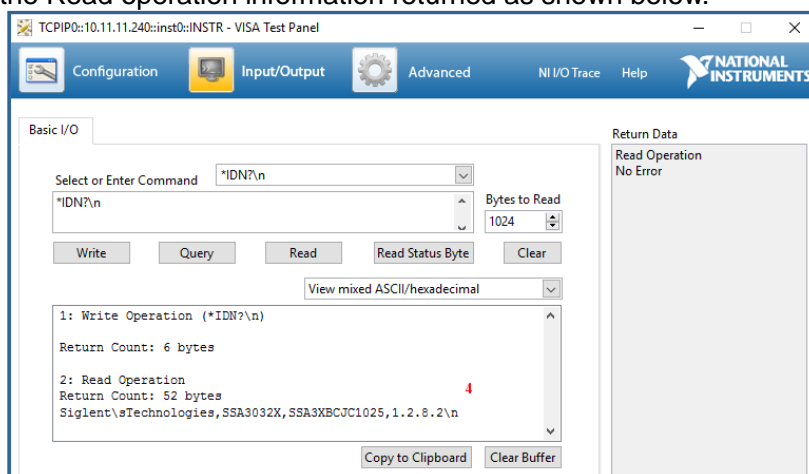

### 1.3.3 EasySpectrum Software

Users can control the spectrum analyzer remotely by EasySpectrum. PC software EasySpectrum is an easy-to-use, PC-Windows-based remote control tool for Siglent's spectrum analyzer. You can download it from Siglent's website. To connect the analyzer via the USB/LAN port to a PC, you need install the NI VISA first.

It is able to be used as:

- ◆ A monitor to display and control the trace scans simultaneously with the analyzer;
- ◆ A filemaker to get user defined Limit/Correction files, and load them to the analyzer;
- ◆ An EMI receiver to perform EMI Pre-compliance test including prescan, peak search, finalscan and report generating.

For the further description of the software, please refer to the online help embedded in this software.

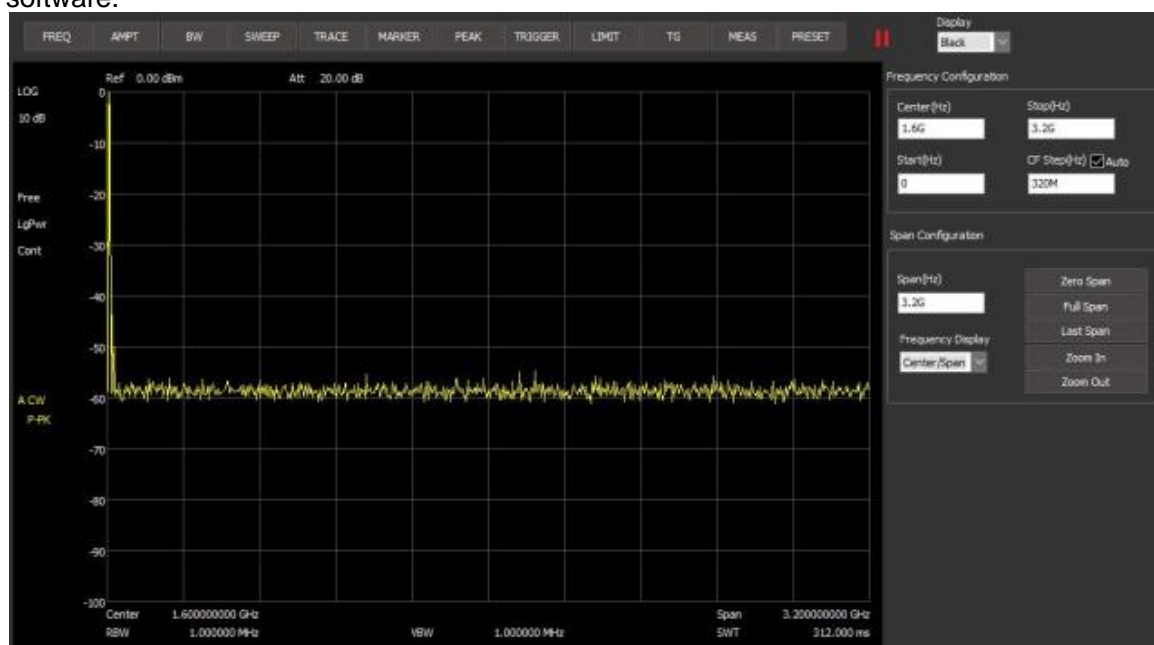

---

## 2.SCPi Overview

### 2.1 Command Format

SCPI commands present a hierarchical tree structure containing multiple subsystems, each of the subsystems is made up of a root keyword and several subkeywords. The command string usually starts with “:”, the keywords are separated by “:” and the followed parameter settings are separated by space. Query commands add “?” at the end of the string.

For example:

```
:SENSe:FREQuency:CENTer <freq>
```

```
:SENSe:FREQuency:CENTer?
```

SENSe is the root key of the command, FREQuency and CENTer are second and third keywords. The command begins with “:”, and separates the keywords at the same time, <freq> separated by space and represents the parameter available for setting; “?” represents a query.

### 2.2 Symbol Instruction

The following four symbols are not the content of SCPI commands and can not be sent with the commands, but are usually used in the commands.

#### 1, Triangle Brackets < >

The parameter in the triangle brackets must be replaced by an effective value. For example:

Send the “:DEMod:VOLume <value>” command in “:DEMod:VOLume 5”.

#### 2, Square Brackets [ ]

The content in the square brackets can be ignored. When the parameter is ignored, the instrument will set the parameter to its default. For example,

In the “[:SENSe]:POWer[:RF]:ATTenuation?” command, sending any of the four commands below can generate the same effect:

```
:POWer:ATTenuation?
```

```
:POWer:RF:ATTenuation?
```

```
:SENSe:POWer:ATTenuation?
```

```
:SENSe:POWer:RF:ATTenuation?
```

#### 3, Vertical Bar |

The vertical bar is used to separate multiple parameters and when sending the command, you can choose one of the parameters. For example,

## SIGLENT

---

In the “[:SENSe]:FREQUency:CENTer:STEP:AUTO OFF|ON|0|1” command, the parameters available are “OFF”, “ON”, “0” or “1”.

### 4, Braces { }

The parameters in the braces are optional which can be ignored or set for one or more times.

For example :

:CALCulate:LLINE[1]|2:DATA <x-axis>,<ampl>{,<x-axis>, <ampl>}, in the command, the {,<x-axis>, <ampl>} parameters can be ignored or set for one or more times.

## 2.3 Parameter Type

The parameters in the commands introduced in this manual include 6 types: boolean, enumeration, integer, float, discrete and string.

### 1, Boolean

The parameters in the commands could be “OFF”, “ON”, “0” or “1”. For example:

[:SENSe]:FREQUency:CENTer:STEP:AUTO OFF|ON|0|1

### 2, Enumeration

The parameter could be any of the values listed. For example:

[:SENSe]:AVERAge:TYPE LOGPower|POWER|VOLTage

The parameter is “LOGPower”, “POWER” or “VOLTage”.

### 3, String

The parameter should be the combinations of ASCII characters. For example:

:SYSTem:COMMunicate:LAN:IPADdress <“xxx.xxx.xxx.xxx”>

The parameter can be set as “192.168.1.12” string.

### 4, Integer

Except other notes, the parameter can be any integer within the effective value range. For example:

[:SENSe]:DEMod:VOLume <value>

The parameter < value > can be set to any integer between 0 and 10.

### 5, Float

The parameter could be any value within the effective value range according to the accuracy requirement (the default accuracy contains up to 9 digits after the decimal points). For example:

:CALCulate:BANDwidth:NDB <value>

The parameter < value > can be set to any real number between -100 and 100.

## 6, Discrete

The parameter could only be one of the specified values and these values are discontinuous. For example:

`[:SENSe]:BWIDth:VIDeo:RATio <number>`

The parameter <number> could only be one of 0.001, 0.003, 0.01, 0.03, 0.1, 0.3, 1.0, 3.0, 10.0, 30.0, 100.0, 300.0, 1000.0.

## 2.4 Command Abbreviation

All of the commands are not case sensitive, so you can use any of them. But if abbreviation is used, all the capital letters in the command must be written completely. For example:

`:DISPlay:WINDow:TRACe:Y:DLINe:STATe?`

Can be abbreviated to:

`:DISP:WIND:TRAC:Y:DLIN:STAT?`

# 3. System Commands

This chapter introduces the Siglent Technologies SSA3000X SCPI commands, include:

IEEE Common Commands	<a href="#">0</a>
System Subsystem	<a href="#">3.2</a>
Instrument Subsystem	<a href="#">3.3</a>
Initiate Subsystem	<a href="#">3.4</a>
Sense Subsystem	<a href="#">3.5</a>
Calculate Subsystem	<a href="#">3.6</a>
Measurement Subsystem	<a href="#">3.7</a>
Trigger Subsystem	<a href="#">3.8</a>
TG Subsystem	<a href="#">3.9</a>
Demod Subsystem	<a href="#">3.10</a>
Calibration Subsystem	<a href="#">3.11</a>

## 3.1 IEEE Common Commands

### 3.1.1 Identification Query (\*IDN)

Command Format	*IDN?
Instruction	Returns an instrument identification information string. The string will contain the manufacturer, model number, serial number, software number, FPGA number and CPLD number.
Menu	None
Example	*IDN? Return: Siglent Technologies,SSA3032,1234567890,100.01.01.06.01

### 3.1.2 Reset (\*RST)

Command Format	*RST
Instruction	This command presets the instrument to a factory defined condition that is appropriate for remote programming operation. *RST is equivalent to performing the two commands :SYSTem:PRESet and *CLS. This command always performs a factory preset.
Menu	None
Example	*RST

### 3.1.3 Clear Status (\*CLS)

Command Format	*CLS
Instruction	Clears the status byte register. It does this by emptying the error queue and

	clearing all bits in all of the event registers. The status byte register summarizes the states of the other registers. It is also responsible for generating service requests.
Menu	None
Example	*CLS

### 3.1.4 Standard Event Status Enable (\*ESE)

Command Format	*ESE <number> *ESE?
Instruction	Set the bits in the standard event status enable register. This register monitors I/O errors and synchronization conditions such as operation complete, request control, query error, device dependent error, execution error, command error and power on. A summary bit is generated on execution of the command. The query returns the state of the standard event status enable register.
Menu	None
Example	*ESE 16

### 3.1.5 Standard Event Status Register Query (\*ESR)

Command Format	*ESR?
Instruction	Queries and clears the standard event status event register. (This is a destructive read.) The value returned reflects the current state (0/1) of all the bits in the register.
Menu	None
Example	*ESR?

### 3.1.6 Operation Complete Query (\*OPC)

Command Format	*OPC *OPC?
Instruction	Set bit 0 in the standard event status register to "1" when all pending operations have finished. The query stops any new commands from being processed until the current processing is complete. Then it returns a "1", and the program continues. This query can be used to synchronize events of other instruments on the external bus. Returns a "1" if the last processing is complete. Use this query when there's a need to monitor the command execution status, such as a sweep execution.
Menu	None
Example	*OPC?

### 3.1.7 Service Request Enable (\*SRE)

Command Format	*SRE <integer> *SRE?
Instruction	This command enables the desired bits of the service request enable register. The query returns the value of the register, indicating which bits are currently enabled. The default value is 255.
Menu	None
Example	*SRE 1

### 3.1.8 Status Byte Query (\*STB)

Command Format	*STB
Instruction	This query is used by some instruments for a self test.
Menu	None
Example	*STB

### 3.1.9 Wait-to-Continue (\*WAI)

Command Format	*WAI
Instruction	This command causes the instrument to wait until all pending commands are completed before executing any additional commands. There is no query form to the command.
Menu	None
Example	*WAI

### 3.1.10 Self Test Query (\*TST)

Command Format	*TST?
Instruction	This query is used by some instruments for a self test.
Menu	None
Example	*TRG

## 3.2 System Subsystem

### 3.2.1 System Time (:SYSTem:TIME)

Command Format	:SYSTem:TIME <hhmmss> :SYSTem:TIME?
Instruction	Sets System time. Gets System time.
Parameter Type	String
Parameter Range	hour(0~23), minute(0~59), second(0~59)
Return	String
Default	None
Menu	System > date & time
Example	Sets System time: :SYSTem:TIME 182559 Gets System time: :SYSTem:TIME?

### 3.2.2 System Date (:SYSTem:DATE)

Command Format	:SYSTem:DATE <yyyymmdd> :SYSTem:DATE?
Instruction	Sets system date. Gets system date.



Parameter Type	String
Parameter Range	year(four digits), month(1~12), date(1~31)
Return	String
Default	None
Menu	System > date&time
Example	Sets System date: :SYSTem:DATE 20050101 Gets System date: :SYSTem:DATE?

### 3.2.3 IP Address (:SYSTem:COMMunicate:LAN:IPADdress)

Command Format	:SYSTem:COMMunicate:LAN:IPADdress <"xxx.xxx.xxx.xxx"> :SYSTem:COMMunicate:LAN:IPADdress?
Instruction	Sets a host name for the analyzer in network. Gets IP address.
Parameter Type	String
Parameter Range	Conform to the IP Sets standard(0-255:0-255:0-255:0-255)
Return	IP address String
Default	None
Menu	System > Interface > LAN > IP Address
Example	:SYSTem:COMMunicate:LAN:IPADdress "192.168.1.12" :SYSTem:COMMunicate:LAN:IPADdress?

### 3.2.4 Gateway (:SYSTem:COMMunicate:LAN:GATeway)

Command Format	:SYSTem:COMMunicate:LAN:GATeway <"xxx.xxx.xxx.xxx"> :SYSTem:COMMunicate:LAN:GATeway?
Instruction	Sets the gateway for the analyzer in the network. The gateway will be fetched automatically if the IP assignment is set to DHCP. Gets gateway.
Parameter Type	String
Parameter Range	Conform to the IP standard (0-255:0-255:0-255:0-255)
Return	gateway string.
Default	None
Menu	System > Interface > LAN > Gateway
Example	:SYSTem:COMMunicate:LAN:GATeway "192.168.1.1" :SYSTem:COMMunicate:LAN:GATeway?

### 3.2.5 Subnet Mask (:SYSTem:COMMunicate:LAN:SMASk)

Command Format	:SYSTem:COMMunicate:LAN:SMASk <"xxx.xxx.xxx.xxx"> :SYSTem:COMMunicate:LAN:SMASk?
Instruction	Sets the subnet mask according to the PC network Settings. The subnet mask

## SIGLENT

	will be set automatically if the IP assignment is set to DHCP.
Parameter Type	String
Parameter Range	Conform to the IP standard (0-255:0-255:0-255:0-255)
Return	Subnet mask string
Default	None
Menu	System > Interface > LAN > Subnet Mask
Example	:SYSTem:COMMunicate:LAN:SMASk?

### 3.2.6 IP Config (:SYSTem:COMMunicate:LAN:TYPE)

Command Format	:SYSTem:COMMunicate:LAN:TYPE STATIC DHCP :SYSTem:COMMunicate:LAN:TYPE?
Instruction	Toggles the IP assignment Setting between static (manual) and DHCP (dynamic assignment) mode. Gets IP config.
Parameter Type	Enumeration
Parameter Range	STATIC DHCP
Return	Enumeration
Default	None
Menu	System > Interface > LAN > IP Config
Example	:SYSTem:COMMunicate:LAN:TYPE DHCP :SYSTem:COMMunicate:LAN:TYPE?

### 3.2.7 Language (:SYSTem:LANGUage)

Command Format	:SYSTem:LANGUage SCHINESE ENGLISH :SYSTem:LANGUage?
Instruction	Sets language. Gets language.
Parameter Type	Enumeration
Parameter Range	SCHINESE: Chinese ENGLISH: English
Return	Enumeration
Default	None
Menu	System > Language
Example	Sets language :SYSTem:LANGUage SCHINESE Gets language :SYSTem:LANGUage?

### 3.2.8 Power On Type (:SYSTem:PON:TYPE)

Command Format	:SYSTem:PON:TYPE DFT LAST USER :SYSTem:PON:TYPE?
Instruction	Uses command to set analyzer to power on in default, user, or last state. Gets power on type.
Parameter Type	Enumeration

Parameter Range	DFT: Default LAST: Last USER: Custom Configuration
Return	Enumeration
Default	DFT
Menu	System > Pwr/Preset > Power On
Example	SYSTem:PON:TYPE DFT

### 3.2.9 System Preset (:SYSTem:PRESet)

Command Format	:SYSTem:PRESet
Instruction	Use this command to preset the instrument. The preset type is based on the Setting of Preset Type: DFT, User or Last.
Parameter Type	None
Parameter Range	None
Return	None
Default	None
Menu	None
Example	:SYSTem:PRESet

### 3.2.10 System Restart (:SYSTem:REStart)

Command Format	:SYSTem:REStart
Instruction	Use this command to restart the instrument (part of machine may not support).
Parameter Type	None
Parameter Range	None
Return	None
Default	None
Menu	None
Example	:SYSTem:REStart

### 3.2.11 Preset Type (:SYSTem:PRESet:TYPE)

Command Format	:SYSTem:PRESet:TYPE DFT LAST USER :SYSTem:PRESet:TYPE?
Instruction	Uses this command to preset the analyzer to default, user, or last state. Gets preset type.
Parameter Type	Enumeration
Parameter Range	DFT: Default LAST: Last USER: Custom Configuration
Return	Enumeration
Default	DFT
Menu	System > Pwr/Preset > Preset
Example	:SYSTem:PRESet:TYPE DFT

### 3.2.12 Factory ReSet (:SYSTem:FDEFault)

Command Format	:SYSTem:FDEFault
Instruction	Sets both the measure and setting parameters to factory preset parameters.
Parameter Type	None
Parameter Range	None
Return	None
Default	None
Menu	System > Pwr/Preset > Factory Reset
Example	:SYSTem:FDEFault

### 3.2.13 Enable Option (:SYSTem:LKEY)

Command Format	:SYSTem:LKEY <"option">,<"license key">
Instruction	Use this command to enable the specified option with the license key, please restart the instrument to make license active.
Parameter Type	"option": Enumeration " license key": String
Parameter Range	"option": Meas EMI CAT TG " license key": provided by Siglent Technologies, 16 bits String.
Return	None
Default	None
Menu	System > System Info > Load Option
Example	:SYSTem:LKEY EMI,fjbdajffnklmgwno

### 3.2.14 Installed Options Query (:SYSTem:OPTions?)

Command Format	:SYSTem:OPTions?
Instruction	This command returns a list of the options that are installed.
Parameter Type	None
Parameter Range	None
Return	Meas  EMI CAT TG
Default	None
Menu	System > System Info
Example	:SYSTem:OPTions?

### 3.2.15 Power Off (:SYSTem:POWer:OFF)

Command Format	:SYSTem:POWer:OFF
Instruction	Use this command to turn off the instrument.
Parameter Type	None
Parameter Range	None
Return	None
Default	None

Menu	None
Example	:SYSTem:POWer:OFF

### 3.2.16 Screenshot Data (:HCOPY:SDUMP:DATA?)

Command Format	:HCOPY:SDUMP:DATA?
Instruction	Use this command to query the screenshot data(.bmp)
Parameter Type	None
Parameter Range	None
Return	String
Default	None
Menu	System > System Info
Example	:HCOPY:SDUMP:DATA?

### 3.2.17 System Info (:SYSTEM:CONFIGURE:SYSTEM?)

Command Format	:SYSTEM:CONFIGURE:SYSTEM?
Instruction	Use this command to query the system message of the instrument.
Parameter Type	None
Parameter Range	None
Return	String
Default	None
Menu	System > System Info
Example	:SYSTEM:CONFIGURE:SYSTEM?

## 3.3 Instrument Subsystem

### 3.3.1 Instrument Mode (:INSTRUMENT[:SELECT])

Command Format	:INSTRUMENT[:SELECT] SA CAT :INSTRUMENT[:SELECT]?
Instruction	Sets instrument mode.
Parameter Type	Enumeration
Parameter Range	SA: Spec Analyzer CAT: Reflection Meas
Return	Enumeration
Default	SA
Menu	mode
Example	:INSTRUMENT CAT

### 3.3.2 Measure Mode (:INSTRUMENT:MEASURE)

Command Format	:INSTRUMENT:MEASURE OFF ACPR CHPower OBW TPOWER  SPECTrogram TOI :INSTRUMENT:MEASURE?
----------------	---

## SIGLENT

Instruction	Sets measure mode. Gets measure mode.
Parameter Type	Enumeration
Parameter Range	OFF: measure off ACPR: ACPR CHPower: Channel Power OBW: Occupied BW TPOWer: T-POWer SPECTrogram: Spectrogram Monitor TOI: Third-order Intercept Point
Return	Enumeration
Default	OFF
Menu	Measure
Example	:INSTrument:MEASure ACPR

## 3.4 Initiate Subsystem

### 3.4.1 Single Sweep (:INITiate[:IMMediate])

Command Format	:INITiate[:IMMediate]
Instruction	Sets single sweep.
Parameter Type	None
Parameter Range	None
Return	None
Default	None
Menu	Sweep > Single
Example	:INITiate:IMMediate

### 3.4.2 Continuous or Single Sweep (:INITiate:CONTInuous)

Command Format	:INITiate:CONTInuous OFF ON 0 1 :INITiate:CONTInuous?
Instruction	Sets continuous sweep mode on-off. Gets continuous sweep mode state.
Parameter Type	Boolean
Parameter Range	OFF ON 0 1
Return	0 1
Default	ON
Menu	Sweep > Sweep Mode
Example	:INITiate:CONTInuous OFF

## 3.5 Sense Subsystem

### 3.5.1 Frequency Subsection

#### 3.5.1.1 Center Frequency ([:SENSe]:FREQuency:CENTer)

Command Format	[:SENSe]:FREQuency:CENTer <freq> [:SENSe]:FREQuency:CENTer?
Instruction	Sets the center frequency of the spectrum analyzer. Gets the center frequency.
Parameter Type	Float, unit: Hz, KHz, MHz, GHz
Parameter Range	50 Hz~3.199999950 GHz(2.999999950 GHz, 2.099999950 GHz, 1.799999950 GHz, 1.499999950 GHz, 0.999999950 GHz) Zero Span: 0~3.2 GHz(3.0 GHz, 2.1 GHz, 1.8 GHz, 1.5 GHz, 1.0 GHz)
Return	Float, unit: Hz
Default	1.6 GHz(1.5 GHz, 1.05 GHz, 0.9 GHz, 0.75 GHz, 0.5 GHz)
Menu	Frequency > Center Frequency
Example	:FREQuency:CENTer 0.2 GHz

#### 3.5.1.2 Start Frequency ([:SENSe]:FREQuency:STARt)

Command Format	[:SENSe]:FREQuency:STARt <freq> [:SENSe]:FREQuency:STARt?
Instruction	Sets the start frequency of the spectrum analyzer. Gets the start Frequency.
Parameter Type	Float, unit: Hz, KHz, MHz, GHz
Parameter Range	0 Hz~3.199999900 GHz(2.999999900 GHz, 2.099999900 GHz, 1.799999900 GHz, 1.499999900 GHz, 0.999999900 GHz) Zero Span: 0~3.2 GHz(3.0 GHz, 2.1 GHz, 1.8 GHz, 1.5 GHz, 1.0 GHz)
Return	Float, unit: Hz
Default	0 Hz
Menu	Frequency > Start Frequency
Example	:FREQuency:STARt 100 Hz

#### 3.5.1.3 Stop Frequency ([:SENSe]:FREQuency:STOP)

Command Format	[:SENSe]:FREQuency:STOP <freq> [:SENSe]:FREQuency:STOP?
Instruction	Sets the stop frequency of the spectrum analyzer. Gets the stop frequency.
Parameter Type	Float, unit: Hz, KHz, MHz, GHz
Parameter Range	100 Hz~3.2 GHz(3.0 GHz, 2.1 GHz, 1.8 GHz, 1.5 GHz, 1.0 GHz) Zero Span: 0~3.2 GHz(3.0 GHz, 2.1 GHz, 1.8 GHz, 1.5 GHz, 1.0 GHz)
Return	Float, unit: Hz
Default	3.2 GHz(3.0 GHz, 2.1 GHz, 1.8 GHz, 1.5 GHz, 1.0 GHz)
Menu	Frequency > Stop Frequency
Example	:FREQuency:STOP 1.0 GHz

### 3.5.1.4 Center Frequency Step ([:SENSe]:FREQuency:CENTer:STEP[:INCRement])

Command Format	[:SENSe]:FREQuency:CENTer:STEP[:INCRement] <freq> [:SENSe]:FREQuency:CENTer:STEP[:INCRement]?
Instruction	Specifies the center frequency step size. Gets the center frequency step.
Parameter Type	Float, unit: Hz, KHz, MHz, GHz
Parameter Range	1 Hz~3.2 GHz(3.0 GHz, 2.1 GHz, 1.8 GHz, 1.5 GHz, 1.0 GHz)
Return	Float, unit: Hz
Default	320 MHz(300 MHz, 210 MHz, 180 MHz, 150 MHz, 100 MHz)
Menu	Frequency > Freq Step
Example	:FREQuency:CENTer:STEP 2 MHz

### 3.5.1.5 Center Frequency Step Mode ([:SENSe]:FREQuency:CENTer:STEP:AUTO)

Command Format	[:SENSe]:FREQuency:CENTer:STEP:AUTO OFF ON 0 1 [:SENSe]:FREQuency:CENTer:STEP:AUTO?
Instruction	Specifies whether the step size is set automatically based on the span. Gets center frequency step mode.
Parameter Type	Boolean
Parameter Range	OFF ON 0 1
Return	0 1
Default	ON
Menu	Frequency > Freq Step
Example	:FREQuency:CENTer:STEP:AUTO OFF

### 3.5.1.6 Sets CF→Step ([:SENSe]:FREQuency:CENTer:SET:STEP)

Command Format	[:SENSe]:FREQuency:CENTer:SET:STEP
Instruction	Sets step value equal to center frequency.
Parameter Type	None
Parameter Range	None
Return	None
Default	None
Menu	Frequency > CF→Step
Example	:FREQuency:CENTer:SET :STEP

### 3.5.1.7 Frequency Span ([:SENSe]:FREQuency:SPAN)

Command Format	[:SENSe]:FREQuency:SPAN <freq> [:SENSe]:FREQuency:SPAN?
Instruction	Sets the frequency span. Setting the span to 0 Hz puts the analyzer into zero span.



	Gets span value.
Parameter Type	Float, unit: Hz, KHz, MHz, GHz
Parameter Range	0 Hz, 100 Hz ~ 3.2GHz(3.0 GHz, 2.1 GHz, 1.8 GHz, 1.5 GHz, 1.0 GHz)
Return	Float, unit: Hz
Default	3.2 GHz(3.0 GHz, 2.1 GHz, 1.8 GHz, 1.5 GHz, 1.0 GHz)
Menu	Span > Span
Example	:FREQUENCY:SPAN 1 GHz

### 3.5.1.8 Full Span ([:SENSE]:FREQUENCY:SPAN:FULL)

Command Format	[:SENSE]:FREQUENCY:SPAN:FULL
Instruction	Sets the frequency span to full scale.
Parameter Type	None
Parameter Range	None
Return	None
Default	None
Menu	Span > Full Span
Example	:FREQUENCY:SPAN:FULL

### 3.5.1.9 Zero Span ([:SENSE]:FREQUENCY:SPAN:ZERO)

Command Format	[:SENSE]:FREQUENCY:SPAN:ZERO
Instruction	Sets the frequency span to zero span.
Parameter Type	None
Parameter Range	None
Return	None
Default	None
Menu	Span > Zero Span
Example	:FREQUENCY:SPAN:ZERO

### 3.5.1.10 Last Span ([:SENSE]:FREQUENCY:SPAN:PREVIOUS)

Command Format	[:SENSE]:FREQUENCY:SPAN:PREVIOUS
Instruction	Sets the frequency span to the previous span setting.
Parameter Type	None
Parameter Range	None
Return	None
Default	None
Menu	Span > Last Span
Example	:FREQUENCY:SPAN:PREVIOUS

### 3.5.1.11 Zoom In ([:SENSE]:FREQUENCY:SPAN:DOUBLE)

Command Format	[:SENSE]:FREQUENCY:SPAN:DOUBLE
Instruction	Sets the frequency span to half of the previous span setting.
Parameter Type	None
Parameter Range	None
Return	None
Default	None
Menu	Span> Zoom In
Example	:FREQUENCY:SPAN:DOUBLE

### 3.5.1.12 Zoom Out ([:SENSE]:FREQUENCY:SPAN:HALF)

Command Format	[:SENSE]:FREQUENCY:SPAN:HALF
Instruction	Sets the frequency span to double the previous span setting.
Parameter Type	None
Parameter Range	None
Return	None
Default	None
Menu	Span> Zoom Out
Example	:FREQUENCY:SPAN:HALF

## 3.5.2 Auto Tune Subsection

### 3.5.2.1 Auto Tune ([:SENSE]:FREQUENCY:TUNE:IMMEDIATE)

Command Format	[:SENSE]:FREQUENCY:TUNE:IMMEDIATE
Instruction	Auto tune the spectrum analyzer parameter to display the main signal.
Parameter Type	None
Parameter Range	None
Return	None
Default	None
Menu	Auto Tune
Example	:FREQUENCY:TUNE:IMMEDIATE

## 3.5.3 Amplitude Subsection

### 3.5.3.1 Reference Level (:DISPLAY:WINDOW:TRACE:Y[:SCALE]:RLEVEL)

Command	:DISPLAY:WINDOW:TRACE:Y[:SCALE]:RLEVEL <value>
---------	--

Format	:DISPlay:WINDow:TRACe:Y[:SCALe]:RLEVel?
Instruction	This command sets the reference level for the Y-axis. Gets reference level.
Parameter Type	Float, unit: dBm, dBmV, dBuV, V, W
Parameter Range	Unit is dBm: -100 dBm ~ 30 dBm Unit is dBmV: -53.01 dBmV ~ 76.99 dBmV, Unit is dBuV: 6.99 dBuV ~ 136.99 dBuV, Unit is Volts: 2.24 uV ~ 7.07 V Unit is Watts: 100 fW ~ 1 W
Return	Float, unit: dBm
Default	0 dBm
Menu	Amplitude > Ref Level
Example	:DISPlay:WINDow:TRACe:Y:RLEVel 20 DBM

### 3.5.3.2 Input Attenuator ([:SENSE]:POWER[:RF]:ATTenuation)

Command Format	[:SENSE]:POWER[:RF]:ATTenuation <value> [:SENSE]:POWER[:RF]:ATTenuation?
Instruction	Sets the input attenuator of the spectrum analyzer. Gets the input attenuator.
Parameter Type	Integer
Parameter Range	0 dB ~ 50 dB
Return	Integer, unit: dB
Default	20 dB
Menu	Amplitude > Attenuator
Example	:POWER:ATTenuation 10

### 3.5.3.3 Attenuator Auto Mode

#### ([:SENSE]:POWER[:RF]:ATTenuation:AUTO)

Command Format	[:SENSE]:POWER[:RF]:ATTenuation:AUTO OFF ON 0 1 [:SENSE]:POWER[:RF]:ATTenuation:AUTO?
Instruction	This command turns on/off auto input port attenuator state. Gets input port attenuator state.
Parameter Type	Boolean
Parameter Range	OFF ON 0 1
Return	0 1
Default	ON
Menu	Amplitude > Attenuator
Example	:POWER:ATTenuation:AUTO?

### 3.5.3.4 Preamp on-off ([:SENSE]:POWER[:RF]:GAIN[:STATE])

Command Format	[:SENSE]:POWER[:RF]:GAIN[:STATE] OFF ON 0 1 [:SENSE]:POWER[:RF]:GAIN[:STATE]?
Instruction	Turns the internal preamp on/off. Gets preamp on-off state.

## SIGLENT

Parameter Type	Boolean
Parameter Range	OFF ON 0 1
Return	0 1
Default	OFF
Menu	Amplitude > Preamp
Example	:POWER:GAIN ON

### 3.5.3.5 Amplitude Offsets (:DISPlay:WINDow:TRACe:Y:SCALe:RLEVel:OFFSet )

Command Format	:DISPlay:WINDow:TRACe:Y:SCALe:RLEVel:OFFSet <value> :DISPlay:WINDow:TRACe:Y:SCALe:RLEVel:OFFSet?
Instruction	Sets reference offsets. Gets reference offsets.
Parameter Type	Float
Parameter Range	-300dB~300dB
Return	Float, unit: dB
Default	0dB
Menu	Amplitude > Ref OffSets
Example	:DISPlay:WINDow:TRACe:Y:SCALe:RLEVel:OFFSet 2

### 3.5.3.6 Amplitude Units (:UNIT:POWER)

Command Format	:UNIT:POWER DBM DBMV DBUV V W :UNIT:POWER?
Instruction	Specifies amplitude units for the input, output and display. Gets amplitude units.
Parameter Type	Enumeration
Parameter Range	DBM DBMV DBUV V W,
Return	Enumeration
Default	DBM
Menu	Amplitude > Units
Example	:UNIT:POWER DBMV

### 3.5.3.7 Scale Type (:DISPlay:WINDow:TRACe:Y[:SCALe]:SPACing)

Command Format	:DISPlay:WINDow:TRACe:Y[:SCALe]:SPACing LINear LOGarithmic :DISPlay:WINDow:TRACe:Y[:SCALe]:SPACing?
Instruction	Toggles the vertical graticule divisions between logarithmic unit and linear unit. The default logarithmic unit is dBm, and the linear unit is V. Gets scale type.
Parameter Type	Enumeration
Parameter Range	LINear LOGarithmic

Return	Enumeration
Default	LOGarithmic
Menu	Amplitude > Scale Type
Example	:DISPlay:WINDow:TRACe:Y:SPACing LINear

### 3.5.3.8 Scale/Div (:DISPlay:WINDow:TRACe:Y[:SCALe]:PDIVision)

Command Format	:DISPlay:WINDow:TRACe:Y[:SCALe]:PDIVision <integer> :DISPlay:WINDow:TRACe:Y[:SCALe]:PDIVision?
Instruction	This command sets the per-division display scaling for the y-axis when scale type of Y axis is set to Log. Gets Scale/Div when scale type of Y axis is set to Log.
Parameter Type	Float
Parameter Range	1 dB ~ 10 dB
Return	Float, unit: dB
Default	10 dB
Menu	Amplitude > Scale/Div
Example	:DISPlay:WINDow:TRACe:Y:PDIVision 10 dB

### 3.5.3.9 Correction Off ([:SENSe]:CORRection:OFF)

Command Format	[:SENSe]:CORRection:OFF
Instruction	Turn off the amplitude correction function off and all of the correction sets are off.
Parameter Type	None
Parameter Range	None
Return	None
Default	None
Menu	None
Example	:SENSe:CORRection:OFF

### 3.5.3.10 Correction Apply State ([:SENSe]:CORRection:CSET:ALL[:STATe])

Command Format	[:SENSe]:CORRection:CSET:ALL[:STATe] OFF ON 0 1 [:SENSe]:CORRection:CSET:ALL[:STATe]?
Instruction	Turns on or off the amplitude corrections. When turned on, only the correction sets that were turned on are enabled. When turned off, all of the correction Sets are disabled. If there is no correction enabled, state can not be set to on.
Parameter Type	Boolean
Parameter Range	OFF ON 0 1
Return	0 1
Default	OFF
Menu	Amplitude > Corrections > Apply Corrections

Example	:SENSe:CORRection:CSET:ALL:STATe OFF
---------	--------------------------------------

**3.5.3.11 Sets Correction X State Off  
([:SENSe]:CORRection:CSET[1]|2|3|4:OFF)**

Command Format	:SENSe]:CORRection:CSET[1] 2 3 4:OFF [:SENSe]:CORRection:CSET[1] 2 3 4[:STATe]?
Instruction	Turns the amplitude correction function on/off. Gets the amplitude correction function state.
Parameter Type	None
Parameter Range	None
Return	0 1
Default	OFF
Menu	Amplitude > Corrections > Correction1 2 3 4
Example	:CORRection:CSET2:OFF

**3.5.3.12 Set Correction Data  
([:SENSe]:CORRection:CSET[1]|2|3|4:DATA)**

Command Format	:SENSe]:CORRection:CSET[1] 2 3 4:DATA <x1,y1,x2,y2;...> [:SENSe]:CORRection:CSET[1] 2 3 4:DATA?
Instruction	Set correction X data 1 2 3 4 Read correction X data.
Parameter Type	None
Parameter Range	None
Return	String
Default	None
Menu	None
Example	:CORRection:CSET2:DATA?

**3.5.3.13 Current Correction Select  
([:SENSe]:CORRection:SELEct)**

Command Format	:SENSe]:CORRection:SELEct 1 2 3 4 [:SENSe]:CORRection:SELEct?
Instruction	Set current correction for load COR file onto proper CorrectionX. Read current correction.
Parameter Type	Enumeration
Parameter Range	1 2 3 4
Return	1 2 3 4
Default	1
Menu	Amplitude > Corrections > Correction1 2 3 4
Example	:CORRection:CSET2:SELEct 1

### 3.5.3.14 Load Correction Data (:MMEMory:LOAD:CORRection:CSET[1]|2|3|4)

Command Format	:MMEMory:LOAD:CORRection:CSET[1] 2 3 4 <name.COR>
Instruction	Load correction data.
Parameter Type	String
Parameter Range	None
Return	None
Default	None
Menu	Amplitude > Corrections > Correction1 2 3 4 > Load Data
Example	:MMEMory:LOAD:CORRection:CSET1 "oldname.COR"

### 3.5.3.15 Input Impedance ([:SENSE]:CORRection:IMPedance[:INPut][:MAGNitude])

Command Format	[:SENSE]:CORRection:IMPedance[:INPut][:MAGNitude] OHM50  OHM75 [:SENSE]:CORRection:IMPedance[:INPut][:MAGNitude]?
Instruction	Set the input impedance for voltage-to-power conversions. Get the input impedance.
Parameter Type	Enumeration
Parameter Range	OHM50  OHM75
Return	OHM50  OHM75
Default	OHM50
Menu	Amplitude > Corrections
Example	CORRection:IMPedance?

## 3.5.4 Bandwidth Subsection

### 3.5.4.1 Resolution Bandwidth ([:SENSE]:BWIDth[:RESolution])

Command Format	[:SENSE]:BWIDth[:RESolution] <freq> [:SENSE]:BWIDth[:RESolution]?
Instruction	Specifies the resolution bandwidth. For numeric entries, all RBW types choose the nearest (arithmetically, on a linear scale, rounding up) available RBW to the value entered.
Parameter Type	Discrete
Parameter Range	10 Hz, 30 Hz, 100 Hz, 300 Hz, 1 KHz, 3 KHz, 10 KHz, 30 KHz, 100 KHz, 300 KHz, 1 MHz
Return	Float, unit: Hz
Default	1 MHz
Menu	BW > RBW
Example	:BWIDth 1 KHz

### 3.5.4.2 Resolution Bandwidth Auto Mode ([:SENSe]:BWIDth[:RESolution]:AUTO)

Command Format	[:SENSe]:BWIDth[:RESolution]:AUTO OFF ON 0 1 [:SENSe]:BWIDth[:RESolution]:AUTO?
Instruction	Turns on/off auto resolution bandwidth state.
Parameter Type	Boolean
Parameter Range	OFF ON 0 1
Return	0 1
Default	ON
Menu	BW > RBW
Example	:BWID:AUTO On

### 3.5.4.3 Video Bandwidth ([:SENSe]:BWIDth:VIDeo)

Command Format	[:SENSe]:BWIDth:VIDeo <freq> [:SENSe]:BWIDth:VIDeo?
Instruction	Specifies the video bandwidth.
Parameter Type	Discrete
Parameter Range	1 Hz, 3 Hz, 10 Hz, 30 Hz, 100 Hz, 300 Hz, 1 KHz, 3 KHz, 10 KHz, 30 KHz, 100 KHz, 300 KHz, 1 MHz
Return	Float, unit: Hz
Default	1 MHz
Menu	BW > VBW
Example	:BWIDth:VIDeo 10 KHZ

### 3.5.4.4 Auto Video Bandwidth State ([:SENSe]:BWIDth:VIDeo:AUTO)

Command Format	[:SENSe]:BWIDth:VIDeo:AUTO OFF ON 0 1 [:SENSe]:BWIDth:VIDeo:AUTO?
Instruction	This command turns on/off auto video bandwidth state.
Parameter Type	Boolean
Parameter Range	OFF ON 0 1
Return	0 1
Default	ON
Menu	BW > VBW
Example	BWIDth:VIDeo:AUTO OFF

### 3.5.4.5 Video to Resolution Bandwidth Ratio ([:SENSe]:BWIDth:VIDeo:RATio)

Command Format	[:SENSe]:BWIDth:VIDeo:RATio <number> [:SENSe]:BWIDth:VIDeo:RATio?
Instruction	Specifies the ratio of the video bandwidth to the resolution bandwidth.
Parameter	Discrete, Float



Type	
Parameter Range	0.001, 0.003, 0.01, 0.03, 0.1, 0.3, 1.0, 3.0, 10.0, 30.0, 100.0, 300.0, 1000.0
Return	Float
Default	1.0
Menu	BW > VBW/RBW
Example	:BWIDth:VIDeo:RATio 30

### 3.5.4.6 Auto Video to Resolution Bandwidth Ratio State ([:SENSe]:BWIDth:VIDeo:RATio:CONfig?)

Command Format	[:SENSe]:BWIDth:VIDeo:RATio:CONfig?
Instruction	This command turns on/off auto video to resolution bandwidth ratio.
Parameter Type	None
Parameter Range	None
Return	0 1
Default	1
Menu	None
Example	:BWIDth:VIDeo:RATio:CONfig?

### 3.5.4.7 Filter Type ([:SENSe]:FILTer:TYPE)

Command Format	[:SENSe]:FILTer:TYPE EMI GAUSS [:SENSe]:FILTer:TYPE?
Instruction	Sets filter type Gets filter type
Parameter Type	Enumeration
Parameter Range	EMI GAUSS
Return	Enumeration
Default	GAUSS
Menu	BW > Filter Type
Example	:FILTer:TYPE EMI

## 3.5.5 Trace Subsection

### 3.5.5.1 Trace mode (:TRACe[1]|2|3|4:MODE)

Command Format	:TRACe[1] 2 3 4:MODE WRITe MAXHold MINHold VIEW BLANK AVERAge :TRACe[1] 2 3 4:MODE?
Instruction	Selects the display mode for the selected trace.
Parameter Type	Enumeration
Parameter Range	WRITe: puts the trace in the normal mode, updating the data. MAXHold: displays the highest measured trace value for all the data that has been measured since the function was turned on. MINHold: displays the lowest measured trace value for all the data that has

## SIGLENT

	been measured since the function was turned on. VIEW: turns on the trace data so that it can be viewed on the display. BLANK: turns off the trace data so that it is not viewed on the display. AVERAge: averages the trace for test period.
Return	Enumeration
Default	Trace1: WRITe, Trace2 3 4: BLANK
Menu	Trace
Example	:TRAC1:MODE VIEW

### 3.5.5.2 Query Trace Data (:TRACe[:DATA]?)

Command Format	:TRACe[:DATA]? 1 2 3 4
Instruction	This query command returns the current displayed data.
Parameter Type	Enumeration
Parameter Range	1 2 3 4
Return	String
Default	1
Menu	None
Example	:TRACe:DATA? 1

### 3.5.5.3 Query Trace Sweep State (:TRACe:SWEep:STATe?)

Command Format	:TRACe:SWEep:STATe?
Instruction	This query command returns 1 if trace scan is completed else returns 0.
Parameter Type	None
Parameter Range	None
Return	Bool
Default	None
Menu	None
Example	TRACe:SWEep:STATe?

### 3.5.5.4 Trace Data Format(:FORMat[:TRACe][:DATA])

Command Format	:FORMat[:TRACe][:DATA] ASCii REAL :FORMat[:TRACe][:DATA]?
Instruction	Sets trace data type. Gets trace data type.
Parameter Type	Enumeration
Parameter Range	ASCii REAL
Return	String
Default	REAL
Menu	None
Example	:FORMat ASCii

### 3.5.5.5 Trace Math Type (:TRACe:MATH:TYPE)

Command Format	:TRACe:MATH:TYPE Off X-Y+Ref->Z Y-X+Ref->Z X+Y-Ref->Z X+Const->Z X-Const->Z :TRACe:MATH:TYPE?
Instruction	Sets trace math type. Gets trace math type. In this command, the lower-case parameters should not be neglected, for example:X-Y+Ref->Z can not write as X-Y+R->Z.
Parameter Type	Enumeration
Parameter Range	Off: turns off the trace math function. X-Y+Ref->Z: math variable X minus math variable Y and add reference level then to output trace. Y-X+Ref->Z: math variable Y minus math variable X and add reference level then to output trace. X+Y-Ref->Z: math variable X add math variable Y and minus reference level then to output trace. X+Const->Z: math variable X add const then to output trace. X-Const->Z: math variable X minus const then to output trace.
Return	Enumeration
Default	Off
Menu	Trace > Math Type
Example	:TRACe:MATH:TYPE X-Y+Ref->Z

### 3.5.5.6 Trace Math Variable X (:TRACe:MATH:X)

Command Format	:TRACe:MATH:X A B C :TRACe:MATH:X?
Instruction	Sets trace math variable X. Gets trace math variable X.
Parameter Type	Enumeration
Parameter Range	A B C
Return	Enumeration
Default	A
Menu	Trace > Math > Variable X
Example	:TRACe:MATH:X A

### 3.5.5.7 Trace Math Variable Y (:TRACe:MATH:Y)

Command Format	:TRACe:MATH:Y A B C :TRACe:MATH:Y?
Instruction	Sets trace math variable Y. Gets trace math variable Y.
Parameter Type	Enumeration
Parameter Range	A B C
Return	Enumeration
Default	B
Menu	Trace > Math > Variable Y

## SIGLENT

Example	:TRACe:MATH:Y A
---------	-----------------

### 3.5.5.8 Trace Math Output (:TRACe:MATH:Z)

Command Format	:TRACe:MATH:Z A B C :TRACe:MATH:Z?
Instruction	Sets trace math output. Gets trace math output.
Parameter Type	Enumeration
Parameter Range	A B C
Return	Enumeration
Default	C
Menu	Trace > Math > Output
Example	:TRACe:MATH:Z A

### 3.5.5.9 Trace Math Const (:TRACe:MATH:CONSt)

Command Format	:TRACe:MATH:CONSt <const> :TRACe:MATH:CONSt?
Instruction	Sets trace math const. Gets trace math const.
Parameter Type	Enumeration
Parameter Range	-300dB ~300 dB
Return	Float
Default	0.00dB
Menu	Trace > Math > Const
Example	:TRACe:MATH:CONSt 7

## 3.5.6 Detector Subsection

### 3.5.6.1 Type of Detection

#### ([:SENSE]:DETector:TRACe[1]|2|3|4[:FUNCTION])

Command Format	[:SENSE]:DETector:TRACe[1] 2 3 4[:FUNCTION] NEGative POSitive SAMPlE AVERage NORMAL QUASi [:SENSE]:DETector:TRACe[1] 2 3 4[:FUNCTION]?
Instruction	Specifies the detection mode. For each trace interval (bucket), average detection displays the average of all the samples within the interval.
Parameter Type	Enumeration
Parameter Range	NEGative: Negative peak detection displays the lowest sample taken during the interval being displayed. POSitive: Positive peak detection displays the highest sample taken during the interval being displayed. SAMPlE: Sample detection displays the sample taken during the interval being displayed, and is used primarily to display noise or noise-like signals. In sample mode, the instantaneous signal value at the present display point is placed into memory. This detection should not be used to make the most

	<p>accurate amplitude measurement of non noise-like signals.</p> <p><b>AVERage:</b> Average detection is used when measuring the average value of the amplitude across each trace interval (bucket). The averaging method used by the average detector is set to either video or power as appropriate when the average type is auto coupled.</p> <p><b>NORMAL:</b> Normal detection selects the maximum and minimum video signal values alternately. When selecting Normal detection, "Norm" appears in the upper-left corner.</p> <p><b>QUASi:</b> Quasipeak detection is a form of detection where a signal level is weighted based on the repetition frequency of the spectral components making up the signal. That is to say, the result of a quasi-peak measurement depends on the repetition rate of the signal.</p>
Return	Enumeration
Default	POSitive
Menu	Detect
Example	:DETector:TRAC1 AVERage

### 3.5.7 Average Subsection

#### 3.5.7.1 Average Type ([:SENSE]:AVERage:TYPE)

Command Format	[:SENSE]:AVERage:TYPE LOGPower POWER VOLTage [:SENSE]:AVERage:TYPE?
Instruction	Toggle the average type between Log power, power and voltage.
Parameter Type	Enumeration
Parameter Range	LOGPower POWER VOLTage
Return	Enumeration
Default	LOGPower
Menu	BW > Avg Type
Example	AVERage:TYPE VOLTage

#### 3.5.7.2 Average Number ([:SENSE]:AVERage:TRACe[1]|2|3|4:COUNT)

Command Format	[:SENSE]:AVERage:TRACe[1] 2 3 4:COUNT <integer> [:SENSE]:AVERage:TRACe[1] 2 3 4:COUNT?
Instruction	Specifies the number of measurements that are combined.
Parameter Type	Integer
Parameter Range	1 ~ 999
Return	Integer
Default	1
Menu	Trace > Avg Times
Example	:AVERage:TRACe1:COUNT 10

### 3.5.7.3 Average Restart ([:SENSE]:AVERage:TRACe[1]|2|3|4:CLEar)

Command Format	[:SENSE]:AVERage:TRACe[1] 2 3 4:CLEar
Instruction	Restarts the trace average. This command is only available when average is on.
Parameter Type	None
Parameter Range	None
Return	None
Default	None
Menu	None
Example	:AVERage:TRAC1:CLEar

## 3.5.8 Sweep Subsection

### 3.5.8.1 Sweep Mode ([:SENSE]:SWEep:MODE)

Command Format	[:SENSE]:SWEep:MODE AUTO FFT SWEep [:SENSE]:SWEep:MODE?
Instruction	Sets sweep mode. Gets sweep mode.
Parameter Type	Enumeration
Parameter Range	AUTO FFT SWEep
Return	Enumeration
Default	SWEep
Menu	Sweep
Example	:SWEep:MODE SWEep

### 3.5.8.2 Sweep Time ([:SENSE]:SWEep:TIME)

Command Format	[:SENSE]:SWEep:TIME <time> [:SENSE]:SWEep:TIME?
Instruction	Specifies the time in which the instrument sweeps the display. A span value of 0 Hz causes the analyzer to enter zero span mode. In zero span the X-axis represents time rather than frequency.
Parameter Type	Float, unit: ks, s, ms, us
Parameter Range	917us ~ 1000 s
Return	Float, unit: s
Default	312.416ms(216.288ms, 192.256ms, 168.224ms, 120.160ms)
Menu	Sweep > Sweep Time
Example	:SWEep:TIME 5s

### 3.5.8.3 Sweep Time State ([:SENSe]:SWEep:TIME:AUTO)

Command Format	[:SENSe]:SWEep:TIME:AUTO OFF ON 0 1 [:SENSe]:SWEep:TIME:AUTO?
Instruction	This command turns on/off auto sweep time state.
Parameter Type	Boolean
Parameter Range	OFF ON 0 1
Return	0 1
Default	ON
Menu	Sweep > Sweep Time
Example	:SWEep:TIME:AUTO ON

### 3.5.8.4 Sweep Speed ([:SENSe]:SWEep:SPEEd)

Command Format	[:SENSe]:SWEep:SPEEd NORMAl ACCURacy [:SENSe]:SWEep:SPEEd?
Instruction	Toggles the sweep speed between normal and accuracy.
Parameter Type	Enumeration
Parameter Range	ACCURacy NORMAl
Return	Enumeration
Default	NORMAl
Menu	Sweep > Sweep Rule
Example	:SWEep: SPEEd NORMAl

### 3.5.8.5 Sweep Numbers ([:SENSe]:SWEep:COUNT)

Command Format	[:SENSe]:SWEep:COUNT <integer> [:SENSe]:SWEep:COUNT?
Instruction	Sets sweep numbers, when single sweep on. Gets sweep numbers, when single sweep on.
Parameter Type	Integer
Parameter Range	1 ~ 99999
Return	Integer
Default	1
Menu	Sweep > Numbers
Example	:SWEep:COUNT 10

### 3.5.8.6 QPD Time ([:SENSe]:QPD:DWELI:TIME)

Command Format	[:SENSe]:QPD:DWELI:TIME < time > [:SENSe]:QPD:DWELI:TIME?
Instruction	Sets QPD Time Gets QPD Time
Parameter Type	Float, unit: s, ms, us
Parameter	0us ~ 10s(qusai-peak: 900us ~ 30ks)

## SIGLENT

Range	
Return	Float, unit: s
Default	500ms
Menu	Sweep > QPD Time
Example	:QPD:DWELI:TIME 10s

### 3.5.9 Display Subsection

#### 3.5.9.1 Grid Brightness

(:DISPlay:WINDow:TRACe:GRATicule:GRID:BRIGHtness)

Command Format	:DISPlay:WINDow:TRACe:GRATicule:GRID:BRIGHtness <value> :DISPlay:WINDow:TRACe:GRATicule:GRID:BRIGHtness?
Instruction	Sets grid brightness. Gets grid brightness.
Parameter Type	Integer
Parameter Range	0 ~ 100
Return	Float
Default	30%
Menu	Display > Grid Brightness
Example	:DISPlay:WINDow:TRACe:GRATicule:GRID:BRIGHtness 50

#### 3.5.9.2 Display Line on-off

(:DISPlay:WINDow:TRACe:Y:DLINe:STATe)

Command Format	:DISPlay:WINDow:TRACe:Y:DLINe:STATe OFF ON 0 1 :DISPlay:WINDow:TRACe:Y:DLINe:STATe?
Instruction	Toggles the display line between on and off. Gets the display line state.
Parameter Type	Enumeration
Parameter Range	OFF ON 0 1
Return	0 1
Default	OFF
Menu	Display > Display Line
Example	:DISPlay:WINDow:TRACe:Y:DLINe:STATe ON

#### 3.5.9.3 Display Line (:DISPlay:WINDow:TRACe:Y:DLINe)

Command Format	:DISPlay:WINDow:TRACe:Y:DLINe <value> :DISPlay:WINDow:TRACe:Y:DLINe?
Instruction	Sets the amplitude value for the display line. Gets the amplitude value for the display line.
Parameter Type	Float, unit: dBm
Parameter Range	Ref Level ~ Ref Level - 100 dBm
Return	Float, unit: dBm



Default	0 dBm
Menu	Display > Display Line
Example	:DISPlay:WINDow:TRACe:Y:DLINe -10

## 3.6 Calculate Subsystem

### 3.6.1 Marker Subsection

#### 3.6.1.1 Marker On/Off (:CALCulate:MARKer[1]|2|3|4:STATe)

Command Format	:CALCulate:MARKer[1] 2 3 4:STATe OFF ON 0 1 :CALCulate:MARKer[1] 2 3 4:STATe?
Instruction	This command toggles the selected marker status between on and off. Gets marker state.
Parameter Type	Boolean
Parameter Range	OFF ON 0 1
Return	0 1
Default	OFF
Menu	Marker
Example	:CALCulate:MARK1:STATe ON

#### 3.6.1.2 Marker All Off (:CALCulate:MARKer:AOFF)

Command Format	:CALCulate:MARKer:AOFF
Instruction	Turn all the markers off.
Parameter Type	None
Parameter Range	None
Return	None
Default	None
Menu	None
Example	:CALCulate:MARKer:AOFF

#### 3.6.1.3 Marker Mode (:CALCulate:MARKer[1]|2|3|4:MODE)

Command Format	:CALCulate:MARKer[1] 2 3 4:MODE POSition DELTA BAND OFF :CALCulate:MARKer[1] 2 3 4:MODE?
Instruction	Selects the type of markers that you want to activate. Gets the type of markers.
Parameter Type	Enumeration
Parameter Range	POSITION: selects a normal marker that can be positioned on a trace and from which trace information will be generated. DELTA: activates a pair of markers, one of which is fixed at the current marker location. The other marker can then be moved around on the trace. The marker readout shows the marker value which moves.

## SIGLENT

	<p>BAND: activates a pair of markers, one of which is fixed at the current marker location. The two marker can then be moved around on the trace. The marker readout shows the difference between the two markers.</p> <p>OFF: turns the designated marker off. If a marker is not active when the mode is queried, "off" will be returned.</p>
Return	Enumeration
Default	OFF
Menu	Marker
Example	:CALCulate:MARK1:MODE POSition

### 3.6.1.4 Marker to Trace (:CALCulate:MARKer[1]|2|3|4:TRACe)

Command Format	:CALCulate:MARKer[1] 2 3 4:TRACe 1 2 3 4 :CALCulate:MARKer[1] 2 3 4:TRACe?
Instruction	This command assigns the specified marker to the designated trace 1, 2, 3 or 4. Gets the specified marker to which trace.
Parameter Type	Enumeration
Parameter Range	1 2 3 4
Return	Enumeration
Default	1
Menu	Marker > Select Trace
Example	CALCulate:MARK:TRAC 1

### 3.6.1.5 Marker Relative To (:CALCulate:MARKer[1]|2|3|4:RELative:TO)

Command Format	:CALCulate:MARKer[1] 2 3 4:RELative:TO:MARKer 1 2 3 4 :CALCulate:MARKer[1] 2 3 4:RELative:TO:MARKer?
Instruction	Sets marker relative to. Gets marker relative to.
Parameter Type	Enumeration
Parameter Range	1 2 3 4
Return	Enumeration
Default	1
Menu	Marker > Relative To
Example	:CALCulate:MARKer1:RELative:TO:MARK 3

### 3.6.1.6 Marker X Value (:CALCulate:MARKer[1]|2|3|4:X)

Command Format	:CALCulate:MARKer[1] 2 3 4:X <para> :CALCulate:MARKer[1] 2 3 4:X?
Instruction	This command positions the designated marker on its assigned trace at the specified trace X value. The value is in the X-axis units, which can be a frequency or time. The query returns the current X value of the designated marker. When the readout mode is frequency, the query returns the X value of the span of the marker in integer and the unit is "Hz". When the readout mode is time or period, the query returns the X value of the span of the marker in scientific notation and the unit is "s".

	Reference Command: :CALCulate:MARKer[1] 2 3 4:X:READout
Parameter Type	Frequency: Float, unit: Hz, KHz, MHz, GHz, Default "Hz" Time: Float, unit: us, ms, s, ks, Default "s"
Parameter Range	0 Hz ~ 3.2 GHz(3.0 GHz, 2.1 GHz, 1.8 GHz, 1.5 GHz, 1.0 GHz) or 10 ms ~ 1000 s
Return	Float
Default	1.6 GHz(1.5 GHz, 1.05 GHz, 0.9 GHz, 0.75 GHz, 0.5 GHz) or 312.64 ms
Menu	Marker > Normal
Example	:CALCulate:MARKer4:X 0.4 GHz :CALCulate:MARKer4:X 200 ms :CALCulate:MARKer4:X?

### 3.6.1.7 Reference Marker X Value (:CALCulate:MARKer[1]|2|3|4:X:REFerence)

Command Format	:CALCulate:MARKer[1] 2 3 4:X:REFerence <para> :CALCulate:MARKer[1] 2 3 4:X:REFerenc?
Instruction	This command positions the designated reference marker on its assigned trace at the specified trace X value. The value is in the X-axis units, which can be a frequency or time. The query returns the current X value of the designated reference marker. This command only can be used when marker mode is DELTa BAND, Reference Command: :CALCulate:MARKer[1] 2 3 4:MODE When the readout mode is frequency, the query returns the X value of the span of the marker in integer and the unit is "Hz". When the readout mode is time or period, the query returns the X value of the span of the marker in scientific notation and the unit is "s". Reference Command: :CALCulate:MARKer[1] 2 3 4:X:READout
Parameter Type	Frequency: Float, unit: Hz, KHz, MHz, GHz, Default "Hz" Time: Float, unit: us, ms, s, ks, Default "s"
Parameter Range	0 Hz ~ 3.2 GHz(3.0 GHz, 2.1 GHz, 1.8 GHz, 1.5 GHz, 1.0 GHz) or 10 ms ~ 1000 s
Return	Float
Default	1.6 GHz(1.5 GHz, 1.05 GHz, 0.9 GHz, 0.75 GHz, 0.5 GHz) or 312.64 ms
Menu	Marker > Delta Pair
Example	:CALCulate:MARKer1:X:REFerence 1.6 GHz

### 3.6.1.8 Marker Delta X Value (:CALCulate:MARKer[1]|2|3|4:X:DELTA)

Command Format	:CALCulate:MARKer[1] 2 3 4:X:DELTA <para> :CALCulate:MARKer[1] 2 3 4:X:DELTA?
Instruction	This command positions the designated delta marker on its assigned trace at the specified trace X value. The value is in the X-axis units, which can be a frequency or time. The query returns the current X value of the designated delta marker. This command only can be used when marker mode is DELTa BAND, Reference Command: :CALCulate:MARKer[1] 2 3 4:MODE When the readout mode is frequency, the query returns the X value of the span of the marker in integer and the unit is "Hz".

	When the readout mode is time or period, the query returns the X value of the span of the marker in scientific notation and the unit is “s”. Reference Command: :CALCulate:MARKer[1] 2 3 4:X:READout
Parameter Type	Frequency: Float, unit: Hz, KHz, MHz, GHz, Default “Hz” Time: Float, unit: us, ms, s, ks, Default “s”
Parameter Range	0 Hz ~ 3.2 GHz(3.0 GHz, 2.1 GHz, 1.8 GHz, 1.5 GHz, 1.0 GHz) or 10 ms ~ 1000 s
Return	Float
Default	0 Hz or 0 s
Menu	Marker > Delta Pair
Example	:CALCulate:MARKer2:X:DELTA 1.6 GHz

**3.6.1.9 Center Pair Marker X Value  
(:CALCulate:MARKer[1]|2|3|4:X:CENTer)**

Command Format	:CALCulate:MARKer[1] 2 3 4:X:CENTer <para> :CALCulate:MARKer[1] 2 3 4:X:CENTer?
Instruction	Sets the center frequency of the center pair marker and the default unit is Hz. Gets the center frequency of the center pair marker. This command only can be used when marker mode is DELTA BAND, Reference Command: :CALCulate:MARKer[1] 2 3 4:MODE When the readout mode is frequency, the query returns the X value of the span of the marker in integer and the unit is “Hz”. When the readout mode is time or period, the query returns the X value of the span of the marker in scientific notation and the unit is “s”. Reference Command: :CALCulate:MARKer[1] 2 3 4:X:READout
Parameter Type	Frequency: Float, unit: Hz, KHz, MHz, GHz, Default “Hz” Time: Float, unit: us, ms, s, ks, Default “s”
Parameter Range	0 Hz ~ 3.2 GHz(3.0 GHz, 2.1 GHz, 1.8 GHz, 1.5 GHz, 1.0 GHz) or 10 ms ~ 1000 s
Return	Float
Default	1.6 GHz(1.5 GHz, 1.05 GHz, 0.9 GHz, 0.75 GHz, 0.5 GHz) or 10 ms ~ 1000 s
Menu	Marker > Delta Pair > Center
Example	:CALCulate:MARKer3:X:CENTer 1.6 GHz

**3.6.1.10 Span Pair Marker X Value  
(:CALCulate:MARKer[1]|2|3|4:X:SPAN)**

Command Format	:CALCulate:MARKer[1] 2 3 4:X:SPAN <para> :CALCulate:MARKer[1] 2 3 4:X:SPAN?
Instruction	Sets the X value corresponding to the span of the Span Pair marker. Gets the X value corresponding to the span of the Span Pair marker. This command only can be used when marker mode is DELTA BAND, Reference Command: :CALCulate:MARKer[1] 2 3 4:MODE When the readout mode is frequency, the query returns the X value of the span of the marker in integer and the unit is “Hz”. When the readout mode is time or period, the query returns the X value of the span of the marker in scientific notation and the unit is “s”. Reference Command: :CALCulate:MARKer[1] 2 3 4:X:READout

Parameter Type	Frequency: Float, unit: Hz, KHz, MHz, GHz, Default "Hz" Time: Float, unit: us, ms, s, ks, Default "s"
Parameter Range	0 Hz ~ 3.2 GHz(3.0 GHz, 2.1 GHz, 1.8 GHz, 1.5 GHz, 1.0 GHz) or 10 ms ~ 1000 s
Return	Float
Default	0 Hz or 0 s
Menu	Marker > Delta Pair > Span
Example	:CALCulate:MARKer4:X:SPAN 2 GHz

### 3.6.1.11 Query Marker Y Value (:CALCulate:MARKer[1]|2|3|4:Y?)

Command Format	:CALCulate:MARKer[1] 2 3 4:Y?
Instruction	This command reads the current Y value for the designated marker. This command can be used to read the results of noise marker. Make sure that Marker is on, Reference Command: :CALCulate:MARKer[1] 2 3 4:STATE :CALCulate:MARKer[1] 2 3 4:MODE
Parameter Type	None
Parameter Range	None
Return	Float, unit: dBm
Default	None
Menu	Marker > Normal
Example	:CALCulate:MARKer1:Y? Return: -25

### 3.6.1.12 Reference Marker Y Value (:CALCulate:MARKer[1]|2|3|4:Y:REference?)

Command Format	:CALCulate:MARKer[1] 2 3 4:Y:REference?
Instruction	Gets the current Y value for the designated reference marker. This command only can be used when marker mode is DELTa BAND, Reference Command: :CALCulate:MARKer[1] 2 3 4:MODE
Parameter Type	None
Parameter Range	None
Return	Float, unit: dBm
Default	None
Menu	Marker > Delta Pair
Example	:CALCulate:MARKer1:Y:REference? Return: -25

### 3.6.1.13 Marker Delta Y Value (:CALCulate:MARKer[1]|2|3|4:Y:DELTA?)

Command Format	:CALCulate:MARKer[1] 2 3 4:Y:DELTA?
----------------	-------------------------------------

## SIGLENT

Instruction	Gets the current Y value for the designated delta marker. This command only can be used when marker mode is DELTa BAND, Reference Command: :CALCulate:MARKer[1] 2 3 4:MODE
Parameter Type	None
Parameter Range	None
Return	Float, unit: dBm
Default	None
Menu	Marker > Delta Pair
Example	:CALCulate:MARKer1:Y:DELTA? Return: -25

### 3.6.1.14 Marker Table (:CALCulate:MARKer:TABLE)

Command Format	:CALCulate:MARKer:TABLE ON OFF 0 1 :CALCulate:MARKer: TABLE?
Instruction	Toggles the marker table between on and off. Gets the status of the marker table.
Parameter Type	Boolean
Parameter Range	ON OFF 0 1
Return	0 1
Default	0
Menu	Marker > Marker Table
Example	:CALCulate:MARKer:TABLE ON

### 3.6.1.15 Marker to Start Frequency (:CALCulate:MARKer[1]|2|3|4[:SET]:START)

Command Format	:CALCulate:MARKer[1] 2 3 4[:SET]:START
Instruction	Sets the start frequency to the value of the specified marker frequency. This command is not available in zero span. If the Marker is OFF, it will set the marker on center.
Parameter Type	None
Parameter Range	None
Return	None
Default	None
Menu	Marker > M→Start Freq
Example	:CALCulate:MARKer1:START

### 3.6.1.16 Marker to Stop Frequency (:CALCulate:MARKer[1]|2|3|4[:SET]:STOP)

Command Format	:CALCulate:MARKer[1] 2 3 4[:SET]:STOP
Instruction	Sets the stop frequency to the value of the specified marker frequency. This

	command is not available in zero span. If the Marker is OFF, it will set the marker on center.
Parameter Type	None
Parameter Range	None
Return	None
Default	None
Menu	Marker > Marker→Stop Freq
Example	:CALCulate:MARKer1:STOP

### 3.6.1.17 Marker to Center Frequency (:CALCulate:MARKer[1]|2|3|4[:SET]:CENTer)

Command Format	:CALCulate:MARKer[1] 2 3 4[:SET]:CENTer
Instruction	This command sets the center frequency equal to the specified marker frequency, which moves the marker to the center of the screen. This command is not available in zero span. If the Marker is OFF, it will set the marker on center.
Parameter Type	None
Parameter Range	None
Return	None
Default	None
Menu	Marker > M→CF
Example	:CALCulate:MARKer1:CENTer

### 3.6.1.18 Marker to Center Frequency Step (:CALCulate:MARKer[1]|2|3|4[:SET]:STEP)

Command Format	:CALCulate:MARKer[1] 2 3 4[:SET]:STEP
Instruction	This command sets the center frequency step equal to the specified marker frequency. This command is not available in zero span. If the Marker is OFF, it will set the marker on center.
Parameter Type	None
Parameter Range	None
Return	None
Default	None
Menu	Marker > M→CF Step
Example	:CALCulate:MARKer1:STEP

### 3.6.1.19 Marker to Reference Level (:CALCulate:MARKer[1]|2|3|4[:SET]:RLEVel)

Command Format	:CALCulate:MARKer[1] 2 3 4[:SET]:RLEVel
Instruction	This command sets the reference level equal to the specified marker frequency.

## SIGLENT

	If the Marker is OFF, it will set the marker on center.
Parameter Type	None
Parameter Range	None
Return	None
Default	None
Menu	Marker > M→Ref Level
Example	:CALCulate:MARKer2:RLEVel

### 3.6.1.20 Marker Delta to Span (:CALCulate:MARKer[1]|2|3|4:DELTA[:SET]:SPAN)

Command Format	:CALCulate:MARKer[1] 2 3 4:DELTA[:SET]:SPAN
Instruction	This command sets the span equal to the specified delta marker frequency. This command can be only used in DELTA BAND marker mode, Reference Command:CALCulate:MARKer[1] 2 3 4:MODE
Parameter Type	None
Parameter Range	None
Return	None
Default	None
Menu	Marker > Δ M→Span
Example	:CALCulate:MARKer2:DELTA:SPAN

### 3.6.1.21 Marker Delta to Center Frequency (:CALCulate:MARKer[1]|2|3|4:DELTA[:SET]:CENTER)

Command Format	:CALCulate:MARKer[1] 2 3 4:DELTA[:SET]:CENTER
Instruction	This command sets the center frequency equal to the specified delta marker frequency. This command can be only used in DELTA BAND marker mode, Reference Command:CALCulate:MARKer[1] 2 3 4:MODE
Parameter Type	None
Parameter Range	None
Return	None
Default	None
Menu	Marker > Δ M→CF
Example	:CALCulate:MARKer3:DELTA:CENTER

### 3.6.1.22 Peak Search Type (:CALCulate:MARKer:PEAK:SEARch:MODE)

Command Format	:CALCulate:MARKer:PEAK:SEARch:MODE MAXimum MINimum :CALCulate:MARKer:PEAK:SEARch:MODE?
Instruction	This is for the analyzer's internal peak identification routine to recognize a



	signal as a peak.
Parameter Type	Enumeration
Parameter Range	MAXimum MINimum
Return	Enumeration
Default	MAXimum
Menu	Peak > Search Config > Peak Type
Example	:CALCulate:MARKer:PEAK:SEARch:MODE MINimum

### 3.6.1.23 Peak Threshold (:CALCulate:MARKer:PEAK:THReshold)

Command Format	:CALCulate:MARKer:PEAK:THReshold <value> :CALCulate:MARKer:PEAK:THReshold?
Instruction	Specifies the minimum signal level for the analyzers internal peak identification routine to recognize a signal as a peak. This applies to all traces and all windows. Gets the minimum signal level for the analyzers internal peak identification routine to recognize a signal as a peak.
Parameter Type	Float, unit: dBm
Parameter Range	-200.0 dBm~ 200.0 dBm
Return	Float, unit: dBm
Default	-160.0 dBm
Menu	Peak > Search Config > Peak Threshold
Example	:CALCulate:MARKer:PEAK:THReshold -50

### 3.6.1.24 Peak Excursion (:CALCulate:MARKer:PEAK:EXCursion)

Command Format	:CALCulate:MARKer:PEAK:EXCursion <value> :CALCulate:MARKer:PEAK:EXCursion?
Instruction	Specifies the minimum signal excursion above the threshold for the internal peak identification routine to recognize a signal as a peak.
Parameter Type	Float, unit: dB
Parameter Range	0 ~ 200.0dB
Return	Float, unit: dB
Default	0 dB
Menu	Peak > Search Config > Peak Excursion
Example	:CALCulate:MARKer:PEAK:EXCursion 10

### 3.6.1.25 Peak Table (:CALCulate:MARKer:PEAK:TABLE)

Command Format	:CALCulate:MARKer:PEAK:TABLE ON OFF 0 1 :CALCulate:MARKer:PEAK:TABLE?
Instruction	Toggles the peak table between on and off. Gets the status of the peak table.
Parameter Type	Boolean
Parameter Range	ON OFF 0 1

## SIGLENT

Return	0 1
Default	0
Menu	Peak > Peak Table
Example	:CALCulate:MARKer:PEAK:TABLE ON

### 3.6.1.26 Query Peak Table Data (:CALCulate:PEAK:TABLE)

Command Format	:CALCulate:PEAK:TABLE?
Instruction	Turning peak table data.
Parameter Type	None
Parameter Range	None
Return	String
Default	None
Menu	Peak
Example	:CALCulate:PEAK:TABLE?

### 3.6.1.27 Continuous Peaking Marker (:CALCulate:MARKer[1]|2|3|4:CPEak[:STATE])

Command Format	:CALCulate:MARKer[1] 2 3 4:CPEak[:STATE] OFF ON 0 1 :CALCulate:MARKer[1] 2 3 4:CPEak[:STATE]?
Instruction	Toggles the continuous peak search function between on and off. Gets the continuous peak search function state.
Parameter Type	Boolean
Parameter Range	OFF ON 0 1
Return	0 1
Default	None
Menu	Peak > Cont Peak
Example	:CALCulate:MARKer1:CPEak ON

### 3.6.1.28 Peak Search (:CALCulate:MARKer[1]|2|3|4:MAXimum)

Command Format	:CALCulate:MARKer[1] 2 3 4:MAXimum
Instruction	Performs a peak search based on the search mode settings. (based on the search mode settings, include: peak search mode, peak threshold and peak excursion, Reference Commands: :CALCulate:MARKer:PEAK:SEARch:MODE :CALCulate:MARKer:PEAK:THReshold :CALCulate:MARKer:PEAK: EXCursion)
Parameter Type	None
Parameter Range	None
Return	None
Default	None
Menu	Peak

Example	:CALCulate:MARKer4:MAXimum
---------	----------------------------

### 3.6.1.29 Next Peak Search (:CALCulate:MARKer[1]|2|3|4:MAXimum:NEXT)

Command Format	:CALCulate:MARKer[1] 2 3 4:MAXimum:NEXT
Instruction	Places the selected marker on the next highest signal peak of the current marked peak. (based on the search mode settings, include: peak search mode, peak threshold and peak excursion, Reference Commands: :CALCulate:MARKer:PEAK:SEARch:MODE :CALCulate:MARKer:PEAK:THReshold :CALCulate:MARKer:PEAK: EXCursion)
Parameter Type	None
Parameter Range	None
Return	None
Default	None
Menu	Peak > Next Peak
Example	:CALCulate:MARKer1:MAXimum:NEXT

### 3.6.1.30 Marker Peak Left Search (:CALCulate:MARKer[1]|2|3|4:MAXimum:LEFT)

Command Format	:CALCulate:MARKer[1] 2 3 4:MAXimum:LEFT
Instruction	Places the selected marker on the next highest signal peak to the left of the current marked peak. (based on the search mode settings, include: peak search mode, peak threshold and peak excursion, Reference Commands: :CALCulate:MARKer:PEAK:SEARch:MODE :CALCulate:MARKer:PEAK:THReshold :CALCulate:MARKer:PEAK: EXCursion)
Parameter Type	None
Parameter Range	None
Return	None
Default	None
Menu	Peak > Next Left Peak
Example	:CALCulate:MARKer1:MAXimum:LEFT

### 3.6.1.31 Marker Peak Right Search (:CALCulate:MARKer[1]|2|3|4:MAXimum:RIGHT)

Command Format	:CALCulate:MARKer[1] 2 3 4:MAXimum:RIGHT
Instruction	Places the selected marker on the next highest signal peak to the right of the current marked peak. (based on the search mode settings, include: peak search mode, peak

## SIGLENT

	threshold and peak excursion, Reference Commands: :CALCulate:MARKer:PEAK:SEARch:MODE :CALCulate:MARKer:PEAK:THReshold :CALCulate:MARKer:PEAK: EXCursion)
Parameter Type	None
Parameter Range	None
Return	None
Default	None
Menu	Peak > Next Right Peak
Example	:CALCulate:MARKer1:MAXimum:RIGHT

### 3.6.1.32 Peak to Peak Search (:CALCulate:MARKer[1]|2|3|4:PTPeak)

Command Format	:CALCulate:MARKer[1] 2 3 4:PTPeak
Instruction	Positions a pair of delta markers on the highest and lowest points on the trace.
Parameter Type	None
Parameter Range	None
Return	None
Default	None
Menu	Peak > Peak Peak
Example	:CALCulate:MARKer1:PTPeak

### 3.6.1.33 Marker Function (:CALCulate:MARKer[1]|2|3|4:FUNction)

Command Format	:CALCulate:MARKer[1] 2 3 4:FUNction OFF FCOunt NOISe NDB :CALCulate:MARKer[1] 2 3 4:FUNction?
Instruction	This command selects the marker function for the designated marker. Gets the selected marker function for the designated marker.
Parameter Type	Enumeration
Parameter Range	OFF: refers to the normal function. FCOunt: refers to the frequency counter function. NOISe: refers to the noise measurement function. NDB: refers to the N dB bandwidth function.
Return	Enumeration
Default	OFF
Menu	Marker Fn
Example	:CALCulate:MARK1:FUNction FCOunt

### 3.6.1.34 Query Frequency Counter (:CALCulate:MARKer[1]|2|3|4:FCOunt:X?)

Command Format	:CALCulate:MARKer[1] 2 3 4:FCOunt:X?
Instruction	To query the frequency counter
Parameter	None

Type	
Parameter Range	None
Return	None
Default	None
Menu	Marker Fn > Freq Counter
Example	:CALCulate:MARK:FCOut:X?

### 3.6.1.35 N dB Bandwidth Result (:CALCulate:MARKer[1]|2|3|4:BANDwidth:RESult?)

Command Format	:CALCulate:MARKer[1] 2 3 4:BANDwidth:RESult?
Instruction	Gets the result of N dB bandwidth measurement.
Parameter Type	None
Parameter Range	None
Return	Float
Default	None
Menu	Marker Fn > N dB BW
Example	:CALCulate:MARK1:BANDwidth:RESult?

### 3.6.1.36 N dB Bandwidth Reference Value (:CALCulate:MARKer[1]|2|3|4:BANDwidth[1]|2|3|4:RESult?)

Command Format	:CALCulate:MARKer[1] 2 3 4:BANDwidth:NDB <value> :CALCulate:MARKer[1] 2 3 4:BANDwidth:NDB?
Instruction	Sets the reference value of N dB bandwidth measurement. Gets the reference value of N dB bandwidth measurement.
Parameter Type	Float
Parameter Range	-100dB ~ 100dB
Return	Float
Default	-3 dB
Menu	Marker Fn > N dB BW
Example	:CALCulate:MARK1:BANDwidth:NDB 10 DB

### 3.6.1.37 Marker X-Axis Read Out (:CALCulate:MARKer[1]|2|3|4:X:READout)

Command Format	:CALCulate:MARKer[1] 2 3 4:X:READout FREQuency TIME PERiod :CALCulate:MARKer[1] 2 3 4:X:READout?
Instruction	Toggles the marker X-Axis readout between frequency, time and period. Gets the marker X-Axis readout type.
Parameter Type	Enumeration
Parameter Range	FREQuency TIME PERiod
Return	Enumeration

## SIGLENT

---

Default	FREQuency
Menu	Marker Fn > Read Out
Example	:CALCulate:MARKer1:X:READout FREQuency

### 3.6.2 Limit Subsection

#### 3.6.2.1 Limit Test Start (:CALCulate:LLINe:TEST:START)

Command Format	:CALCulate:LLINe:TEST:START
Instruction	Sets limit test start.
Parameter Type	None
Parameter Range	None
Return	None
Default	None
Menu	Limit > Test
Example	:CALCulate:LLINe:TEST:START

#### 3.6.2.2 Limit Test Stop (:CALCulate:LLINe:TEST:STOP)

Command Format	:CALCulate:LLINe:TEST:STOP
Instruction	Sets limit test stop.
Parameter Type	None
Parameter Range	None
Return	None
Default	None
Menu	Limit > Test
Example	:CALCulate:LLINe:TEST:STOP

#### 3.6.2.3 Gets Limit Test State (:CALCulate:LLINe:TEST:STATe?)

Command Format	:CALCulate:LLINe:TEST:STATe?
Instruction	Gets limit test state.
Parameter Type	None
Parameter Range	None
Return	0 1
Default	OFF
Menu	Limit > Test
Example	:CALCulate:LLINe:TEST:STAT?

#### 3.6.2.4 Limit Line State (:CALCulate:LLINe[1]|2:STATe)

Command	:CALCulate:LLINe[1] 2:STATe OFF ON 0 1
---------	--

Format	:CALCulate:LLINe[1] 2:STATe?
Instruction	Sets limit line state. Gets limit line state.
Parameter Type	Boolean
Parameter Range	OFF ON 0 1
Return	0 1
Default	OFF
Menu	Limit > Limit1 2
Example	:CALCulate:LLINe1:STATe OFF

### 3.6.2.5 Limit Type (:CALCulate:LLINe[1]|2:TYPE)

Command Format	:CALCulate:LLINe[1] 2:TYPE UPPER LOWER :CALCulate:LLINe[1] 2:TYPE?
Instruction	Mode sets a limit line to be either an upper or lower type limit line. An upper line will be used as the maximum allowable value when comparing with the data. Gets limit type.
Parameter Type	Enumeration
Parameter Range	UPPER LOWER
Return	Enumeration
Default	The default setting of LINE1 is UPPER, the default setting of LINE2 is LOWER
Menu	Limit > Limit1 2 Edit > Type
Example	:CALCulate:LLINe1: TYPE LOWER

### 3.6.2.6 Limit Mode (:CALCulate:LLINe[1]|2:MODE)

Command Format	:CALCulate:LLINe[1] 2:MODE LINE POINT :CALCulate:LLINe[1] 2:MODE?
Instruction	Sets limit mode Gets limit mode
Parameter Type	Enumeration
Parameter Range	LINE POINT
Return	Enumeration
Default	LINE
Menu	Limit > Limit1 2 Edit > Mode
Example	:CALCulate:LLINe1: MODE POINT

### 3.6.2.7 Limit Line Y-axis Value (:CALCulate:LLINe[1]|2:Y)

Command Format	:CALCulate:LLINe[1] 2:Y <value> :CALCulate:LLINe[1] 2:Y?
Instruction	Sets the Y-axis value of a limit line. Limit line Y-axis value is set independently and is not affected by the X-axis units. Gets the Y-axis value of a limit line.
Parameter Type	Float
Parameter	-400 dBm~330 dBm

## SIGLENT

Range	
Return	Float
Default	0dBm
Menu	Limit > Limit1 2 Edit > Amplitude
Example	:CALCulate:LLINe1:Y 5dBm

### 3.6.2.8 Define Limit Points Data (:CALCulate:LLINe[1]|2:DATA)

Command Format	:CALCulate:LLINe[1] 2:DATA <x-axis>,<ampl>{,<x-axis>, <ampl>} :CALCulate:LLINe[1] 2:DATA?
Instruction	Use this command to define the limit points. Gets the defined limit points.
Parameter Type	X-axis: Float Amplitude: Float
Parameter Range	X-axis: 0~3.2GHz Amplitude: -400 dBm~330 dBm
Return	X-axis: Float Amplitude: Float
Default	X-axis: -1Hz Amplitude: 0 dBm
Menu	Limit > Limit1 2 Edit
Example	:CALC:LLINe1:DATA 10000000,-20,20000000,-30

### 3.6.2.9 Add Limit Point Data (:CALCulate:LLINe[1]|2:DATA)

Command Format	:CALCulate:LLINe[1] 2:ADD <x-axis>,<ampl>
Instruction	Add limit point data
Parameter Type	X-axis: Float Amplitude: Float
Parameter Range	X-axis: 0~3.2GHz Amplitude: None
Return	X-axis: Float Amplitude: Float
Default	X-axis: -1Hz Amplitude: 0 dBm
Menu	Limit > Limit1 2 Edit
Example	:CALCulate:LLINe1:ADD 10000000,-20

### 3.6.2.10 Delete Assigned Limit Point (:CALCulate:LLINe[1]|2:DELeTe)

Command Format	:CALCulate:LLINe[1] 2:DELeTe <number>
Instruction	Use this command to delete the assigned limit point.
Parameter Type	Integer
Parameter Range	None
Return	None
Default	None
Menu	Limit > Limit1 2 Edit > Del Point



Example	:CALCulate:LLINe1:DELeTe 2
---------	----------------------------

### 3.6.2.11 Delete All Limit Points (:CALCulate:LLINe:ALL:DELeTe)

Command Format	:CALCulate:LLINe[1] 2:ALL:DELeTe
Instruction	Use this command to define all the limits points.
Parameter Type	None
Parameter Range	None
Return	None
Default	None
Menu	Limit > Limit1 2 Edit > Del All
Example	:CALCulate:LLINe2:ALL:DELeTe

### 3.6.2.12 Limit X-axis Unit (:CALCulate:LLINe:CONTrol:DOMain)

Command Format	:CALCulate:LLINe:CONTrol:DOMain FREQUency TIME :CALCulate:LLINe:CONTrol:DOMain?
Instruction	Toggles the limit X-axis value between frequency and time. Gets the limit X-axis unit.
Parameter Type	Enumeration
Parameter Range	FREQUency TIME
Return	Enumeration
Default	FREQUency
Menu	Limit > Setup > X Axis
Example	:CALCulate:LLINe:CONTrol:DOMain FREQUency

### 3.6.2.13 Limit Beep State (:CALCulate:LLINe:CONTrol:BEEP)

Command Format	:CALCulate:LLINe:CONTrol:BEEP OFF ON 0 1 :CALCulate:LLINe:CONTrol:BEEP?
Instruction	Use this command to turn on/off the limit beep status. Gets limit beep state.
Parameter Type	Boolean
Parameter Range	OFF ON 0 1
Return	0 1
Default	ON
Menu	Limit > Setup > Buzzer
Example	:CALCulate:LLINe:CONTrol:BEEP OFF

### 3.6.2.14 Query Limits Result (:CALCulate:LLINe:FAIL?)

Command Format	:CALCulate:LLINe:FAIL?
Instruction	This query returns the limits pass/failed result. If the test result fails, this command will get result FAIL. If the test result passes, it will get result PASS.

## SIGLENT

Parameter Type	None
Parameter Range	None
Return	PASS FAIL
Default	None
Menu	None
Example	:CALCulate:LLINe:FAIL?

### 3.6.2.15 Limit Fail to Stop (:CALCulate:LLINe:FAIL:STOP)

Command Format	:CALCulate:LLINe:FAIL:STOP OFF ON 0 1 :CALCulate:LLINe:FAIL:STOP?
Instruction	Sets whether to stop the test if the test fails. Gets whether to stop the test if the test fails.
Parameter Type	Boolean
Parameter Range	OFF ON 0 1
Return	0 1
Default	OFF
Menu	Limit > Setup > Fail to stop
Example	:CALCulate:LLINe:FAIL:STOP OFF

## 3.7 Measurement Subsystem

### 3.7.1 ACPR Subsection

#### 3.7.1.1 Main Channel ([[:SENSe]:ACPRatio:BWIDth:INTegration])

Command Format	[[:SENSe]:ACPRatio:BWIDth:INTegration <freq> [:SENSe]:ACPRatio:BWIDth:INTegration?
Instruction	Specifies the range of integration used in calculating the power in the main channel. Gets the range of integration used in calculating the power in the main channel.
Parameter Type	Float, unit: Hz, KHz, MHz, GHz
Parameter Range	100 Hz~3.2 GHz(3.0 GHz, 2.1 GHz, 1.8 GHz, 1.5 GHz, 1.0 GHz)
Return	Float, unit: Hz
Default	1MHz
Menu	Meas > ACPR > Meas Setup > Main Channel
Example	:ACPRatio:BWIDth:INTegration 20 MHz

#### 3.7.1.2 Adjacent Channel Bandwidth ([[:SENSe]:ACPRatio:OFFSet:BWIDth[:INTegration]])

Command Format	[[:SENSe]:ACPRatio:OFFSet:BWIDth[:INTegration] <freq> [:SENSe]:ACPRatio:OFFSet:BWIDth[:INTegration]?
----------------	---

Instruction	Specifies the bandwidth used in calculating the power in the adjacent channel. Gets the bandwidth used in calculating the power in the adjacent channel.
Parameter Type	Float, unit: Hz, KHz, MHz, GHz
Parameter Range	100 Hz~3.2 GHz(3.0 GHz, 2.1 GHz, 1.8 GHz, 1.5 GHz, 1.0 GHz)
Return	Float, unit: Hz
Default	1MHz
Menu	Meas > ACPR > Meas Setup > Adjacent Chn
Example	:ACPRatio:OFFSet:BWIDth 20 MHz

### 3.7.1.3 Channel Space [:SENSe]:ACPRatio:OFFSet[:FREQuency])

Command Format	[:SENSe]:ACPRatio:OFFSet[:FREQuency] <freq> [:SENSe]:ACPRatio:OFFSet[:FREQuency]?
Instruction	Sets the space value between the center frequency of main channel power and that of the adjacent channel power. Gets adjacent channel space
Parameter Type	Float, unit: Hz, KHz, MHz, GHz
Parameter Range	100 Hz~700 MHz
Return	Float, unit: Hz
Default	3MHz
Menu	Meas > ACPR > Meas Setup > Adj Chn Space
Example	:ACPRatio:OFFSets 20 MHz

### 3.7.1.4 Query Main Channel Power (:MEASure:ACPRatio:MAIN?)

Command Format	:MEASure:ACPRatio:MAIN?
Instruction	Return the main channel power of ACPR measurement.
Parameter Type	None
Parameter Range	None
Return	Float, unit: dBm
Default	None
Menu	Meas > ACPR
Example	:MEASure:ACPRatio:MAIN?

### 3.7.1.5 Query Lower Adjacent Channel Power (:MEASure:ACPRatio:LOWer:POWER?)

Command Format	:MEASure:ACPRatio:LOWer:POWER?
Instruction	Return the lower adjacent channel power of ACPR measurement.
Parameter Type	None
Parameter Range	None

## SIGLENT

---

Return	Float, unit: dBm
Default	None
Menu	Meas > ACPR
Example	:MEASure:ACPRatio:LOWer:POWer?

### 3.7.1.6 Query Lower Adjacent Channel Power Ratio (:MEASure:ACPRatio:LOWer?)

Command Format	:MEASure:ACPRatio:LOWer?
Instruction	Return the lower adjacent channel power to main channel power ratio.
Parameter Type	None
Parameter Range	None
Return	Float, unit: dBm
Default	None
Menu	Meas > ACPR
Example	:MEASure:ACPRatio:LOWer?

### 3.7.1.7 Query Upper Adjacent Channel Power (:MEASure:ACPRatio:UPPer:POWer?)

Command Format	:MEASure:ACPRatio:UPPer:POWer?
Instruction	Return the upper adjacent channel power of ACPR measurement.
Parameter Type	None
Parameter Range	None
Return	Float, unit: dBm
Default	None
Menu	Meas > ACPR
Example	:MEASure:ACPRatio:UPPer:POWer?

### 3.7.1.8 Query Upper Adjacent Channel Power Ratio (:MEASure:ACPRatio:UPPer?)

Command Format	:MEASure:ACPRatio:UPPer?
Instruction	Return the upper adjacent channel power to main channel power ratio.
Parameter Type	None
Parameter Range	None
Return	Float
Default	None
Menu	Meas > ACPR
Example	:MEASure:ACPRatio:UPPer?

## 3.7.2 CHP Subsection

### 3.7.2.1 Integration BW ([:SENSe]:CHPower:BWIDth:INTEgration)

Command Format	[:SENSe]:CHPower:BWIDth:INTEgration <freq> [:SENSe]:CHPower:BWIDth:INTEgration?
Instruction	Specifies the integration bandwidth to calculate the power. Gets the integration bandwidth.
Parameter Type	Float, unit: Hz, KHz, MHz, GHz
Parameter Range	100 Hz~3.2 GHz(3.0 GHz, 2.1 GHz, 1.8 GHz, 1.5 GHz, 1.0 GHz) Zero Span: 0~3.2 GHz(3.0 GHz, 2.1 GHz, 1.8 GHz, 1.5 GHz, 1.0 GHz)
Return	Float, unit: Hz
Default	2 MHz
Menu	Meas > Ch Power > Meas Setup > Integration BW
Example	:CHPower:BWIDth:INTEgration 1.8 GHz

### 3.7.2.2 Channel Span ([:SENSe]:CHPower:FREQuency:SPAN:POWer)

Command Format	[:SENSe]:CHPower:FREQuency:SPAN:POWer
Instruction	Sets the analyzer span for the channel power measurement. Be sure the span is set larger than the integration bandwidth.
Parameter Type	None
Parameter Range	None
Return	None
Default	None
Menu	Meas > Ch Power > Meas Setup > Span
Example	:CHPower:FREQuency:SPAN:POWer

### 3.7.2.3 Query Channel Power and Power Spectral Density (:MEASure:CHPower?)

Command Format	:MEASure:CHPower?
Instruction	This command returns scalar results of main channel power, and power density.
Parameter Type	None
Parameter Range	None
Return	Float, Channel Power unit: dBm Float, Density unit: dBm/Hz
Default	None
Menu	Meas > Ch Power
Example	:MEASure:CHPower?

### 3.7.2.4 Query Channel Power (:MEASure:CHPower:CHPower?)

Command Format	:MEASure:CHPower:CHPower?
Instruction	This command returns the value of the channel power in dBm units.
Parameter Type	None
Parameter Range	None
Return	Float
Default	None
Menu	Meas > Ch Power
Example	:MEASure:CHPower:CHPower?

### 3.7.2.5 Query Power Spectral Density (:MEASure:CHPower:DENSity?)

Command Format	:MEASure:CHPower:DENSity?
Instruction	This command returns the value of the channel power density in dBm/Hz.
Parameter Type	None
Parameter Range	None
Return	Float
Default	None
Menu	Meas > Ch Power
Example	:MEASure:CHPower:DENSity?

## 3.7.3 OBW Subsection

### 3.7.3.1 Select the Method of OBW ([:SENSe]:OBWidth:METhod)

Command Format	[:SENSe]:OBWidth:METhod PERCent DBC [:SENSe]:OBWidth:METhod?
Instruction	This command toggles the method of OBW measurement between percent and dBc. Gets the method of OBW measurement.
Parameter Type	Enumeration
Parameter Range	PERCent DBC
Return	Enumeration
Default	PERCent
Menu	Meas > Occupied BW > Meas Setup > Method
Example	:OBW:METhod PERCent

### 3.7.3.2 Set Percentage(%) Method of OBW ([:SENSe]:OBWidth:PERCent)

Command	[:SENSe]:OBWidth:PERCent <para>
---------	---------------------------------

Format	[:SENSe]:OBWidth:PERCent?
Instruction	Edit the percentage of signal power used when determining the occupied bandwidth. Press {%} to set the percentage ranging from 10.00% to 99.99%. Gets the percentage of signal power.
Parameter Type	Float
Parameter Range	10~99.99
Return	Float
Default	99
Menu	Meas > Occupied BW > Meas Setup > %
Example	:OBW:PERCent 50

### 3.7.3.3 Set dBc Method of OBW ([:SENSe]:OBWidth:XDB)

Command Format	[:SENSe]:OBWidth:XDB <value> [:SENSe]:OBWidth:XDB?
Instruction	Specify the power level used to determine the emission bandwidth as the number of dB down from the highest signal point, within the occupied bandwidth span. Gets dBc value.
Parameter Type	Float
Parameter Range	0.1~100
Return	Float
Default	26
Menu	Meas > Occupied BW > Meas Setup > dBc
Example	:OBWidth:XDB 3

### 3.7.3.4 Query OBW and Centroid (:MEASure:OBWidth?)

Command Format	:MEASure:OBWidth?
Instruction	Use this command to query the occupied bandwidth and bandwidth centroid according to the method you set.
Parameter Type	None
Parameter Range	None
Return	Float, unit: Hz
Default	None
Menu	Meas > Occupied BW
Example	:MEASure:OBW?

### 3.7.3.5 Query OBW (:MEASure:OBWidth:OBWidth?)

Command Format	:MEASure:OBWidth:OBWidth?
Instruction	Use this command to query the occupied bandwidth according to the method you set. Query Centroid Result.
Parameter	None

## SIGLENT

Type	
Parameter Range	None
Return	Float, unit: Hz
Default	None
Menu	Meas > Occupied BW
Example	:MEASure:OBW:OBW?

### 3.7.3.6 Query OBW Centroid (:MEASure:OBWidth:CENTroid?)

Command Format	:MEASure:OBWidth:CENTroid?
Instruction	Use this command to query the occupied bandwidth according to the method you set.
Parameter Type	None
Parameter Range	None
Return	Float, unit: Hz
Default	None
Menu	Meas > Occupied BW
Example	: MEASure:OBW:CENTroid?

### 3.7.3.7 Query Transmit Frequency Error (:MEASure:OBWidth:OBWidth:FERRor?)

Command Format	:MEASure:OBWidth:OBWidth:FERRor?
Instruction	Use this command to query transmit frequency error.
Parameter Type	None
Parameter Range	None
Return	Float, unit: Hz
Default	None
Menu	Meas > Occupied BW
Example	:MEASure:OBWidth:OBWidth:FERRor?

## 3.7.4 Subsection T-power(T-Power)

### 3.7.4.1 T-power Center Frequency ([[:SENSe]:TPOWer:FREQUency:CENTer])

Command Format	[[:SENSe]:TPOWer:FREQUency:CENTer <freq> [:SENSe]:TPOWer:FREQUency:CENTer?
Instruction	Sets T-power center frequency. Gets T-power center frequency.
Parameter Type	Float, unit: Hz, KHz, MHz, GHz
Parameter Range	50 Hz~3.199999950 GHz(2.999999950 GHz, 2.099999950 GHz, 1.799999950 GHz, 1.499999950 GHz, 0.999999950 GHz)



	Zero Span: 0~3.2 GHz(3.0 GHz, 2.1 GHz, 1.8 GHz, 1.5 GHz, 1.0 GHz)
Return	Float, unit: Hz
Default	1.6GHz(1.5 GHz, 1.05 GHz, 0.9 GHz, 0.75 GHz, 0.5 GHz)
Menu	Meas > T-power > Meas Setup > Center Freq
Example	:TPOWer:FREQuency:CENTer 15KHz

### 3.7.4.2 T-power Start Line ([:SENSE]:TPOWER:LLIMit)

Command Format	[:SENSE]:TPOWER:LLIMit <time> [:SENSE]:TPOWER:LLIMit?
Instruction	Sets T-power start line. Gets T-power start line.
Parameter Type	Float, unit: ks, s, ms, us
Parameter Range	0 ~ 1000 s
Return	Float, time unit: s
Default	0
Menu	Meas > T-power > Meas Setup > Start Line
Example	:TPOWer:LLIMit 0.01

### 3.7.4.3 T-power Stop Line ([:SENSE]:TPOWER:RLIMit)

Command Format	[:SENSE]:TPOWER:RLIMit <time> [:SENSE]:TPOWER:RLIMit?
Instruction	Sets T-power stop line. Gets T-power stop line.
Parameter Type	Float, unit: ks, s, ms, us
Parameter Range	0 ~ 1000 s
Return	Float, time unit: s
Default	20ms
Menu	Meas > T-power > Meas Setup > Stop Line
Example	:TPOWer:RLIMit 0.02

### 3.7.4.4 Query T-power (:MEASure:TPOWER?)

Command Format	:MEASure:TPOWER?
Instruction	Query the result of T-power measurement.
Parameter Type	Float, unit: dBm
Parameter Range	None
Return	Float, unit: dBm
Default	None
Menu	Meas > T-power
Example	:MEASure:TPOWER?

## 3.7.5 Spectrum Monitor (SPECTrogram)

### 3.7.5.1 Spectrogram state([:SENSE]:SPECTrogram:STATE)

Command Format	[:SENSE]:SPECTrogram:STATE RUN PAUSE [:SENSE]:SPECTrogram:STATE?
Instruction	Sets spectrogram state. Gets spectrogram state.
Parameter Type	Enumeration
Parameter Range	RUN: Start PAUSE: Pause
Return	RUN PAUSE
Default	RUN
Menu	Meas > Spectrum Monitor > Meas Setup > Spectrogram
Example	:SPECTrogram:STATE PAUSE

### 3.7.5.2 Spectrogram Restart ([:SENSE]:SPECTrogram:REStart)

Command Format	[:SENSE]:SPECTrogram:REStart
Instruction	Restart spectrogram.
Parameter Type	None
Parameter Range	None
Return	None
Default	None
Menu	Meas > Spectrum Monitor > Meas Setup > Restart
Example	:SPECTrogram:REStart

## 3.7.6 Third-order Intercept Point (TOI)

### 3.7.6.1 Query Third-order Intercept Point result(:MEASure:TOI?)

Command Format	:MEASure:TOI?
Instruction	Gets the result of Third-order Intercept Point
Parameter Type	None
Parameter Range	None
Return	Float
Default	None
Menu	Meas > TOI
Example	:MEASure:TOI?

### 3.7.6.2 Query Third-order Intercept Point(:MEASure:TOI:IP3?)

Command Format	:MEASure:TOI:IP3?
Instruction	Gets the min intercept of the Lower TOI(Lower 3rd) and the Upper TOI(Upper 3rd)
Parameter Type	None
Parameter Range	None
Return	Float
Default	None
Menu	Meas > TOI
Example	:MEASure:TOI:IP3?

## 3.8 Trigger Subsystem

### 3.8.1 Trigger Type (:TRIGger[:SEQuence]:SOURce)

Command Format	:TRIGger[:SEQuence]:SOURce IMMEDIATE VIDEO EXTERNAL :TRIGger[:SEQuence]:SOURce?
Instruction	Specifies the source (or type) of triggering used to start a measurement. Gets trigger type.
Parameter Type	Enumeration
Parameter Range	IMMEDIATE: free-run triggering. VIDEO: triggers on the video signal level. EXTERNAL: allows you to connect an external trigger source.
Return	Enumeration
Default	IMMEDIATE
Menu	Trigger
Example	:TRIGger:SOURce IMMEDIATE

### 3.8.2 Video Trigger Level (:TRIGger[:SEQuence]:VIDeo:LEVel)

Command Format	:TRIGger[:SEQuence]:VIDeo:LEVel <value> :TRIGger[:SEQuence]:VIDeo:LEVel?
Instruction	Specifies the level at which a video trigger will occur. Video is adjusted using this command, but must also be selected using the command. Gets video Trigger Level.
Parameter Type	Float, unit: dBm, dBmV, dBuV, V, W
Parameter Range	Unit is dBm: -300 dBm ~ 50 dBm unit is dBmV: -253.01 dBmV ~ 96.99 dBmV unit is dBuV: -193.01 dBuV ~ 156.99 dBuV unit is Volts: 223.61 aV ~ 70.71 V unit is Watts: 1.00E-33 W ~ 100 W
Return	Float, unit: dBm, dBmV, dBuV, V, W
Default	0 dBm
Menu	Trigger > Video Level
Example	:TRIGger:VIDeo:LEVel 0.5 dBm

### 3.8.3 Trigger Edge (:TRIGger[:SEQuence]:RFBurst:SLOPe)

Command Format	:TRIGger[:SEQuence]:RFBurst:SLOPe POSitive NEGative :TRIGger[:SEQuence]:RFBurst:SLOPe?
Instruction	This command activates the trigger condition that allows the next sweep to start when the external voltage (connected to EXT TRIG IN connector) passes through approximately 1.5 volts. The external trigger signal must be a 0V to +5V TTL signal. This function only controls the trigger polarity (for positive or negative-going signals). Gets Trigger edge.
Parameter Type	Enumeration
Parameter Range	POSitive: positive edge. NEGative: negative edge.
Return	Enumeration
Default	POSitive
Menu	Trigger > External Trigger
Example	:TRIGger:RFBurst:SLOPe POSitive

## 3.9TG Subsystem

### 3.9.1 TG On-off (:OUTPut[:STATe])

Command Format	:OUTPut[:STATe] OFF ON 0 1 :OUTPut[:STATe]?
Instruction	Sets TG on-off. Gets TG state.
Parameter Type	Boolean
Parameter Range	OFF ON 0 1
Return	0 1
Default	0
Menu	TG > TG
Example	:OUTPut ON

### 3.9.2 TG Level (:SOURce:POWer[:LEVel][:IMMediate][:AMPLitude])

Command Format	:SOURce:POWer[:LEVel][:IMMediate][:AMPLitude] <value> :SOURce:POWer[:LEVel][:IMMediate][:AMPLitude]?
Instruction	Sets TG level. Gets TG level.
Parameter Type	Float, unit: dBm
Parameter Range	0 dBm ~ -20 dBm
Return	Float
Default	0 dBm
Menu	TG > TG Level
Example	:SOURce:POWer -20

### 3.9.3 TG Level OffSets (:SOURce:CORRection:OFFSet )

Command Format	:SOURce:CORRection:OFFSet <value> :SOURce:CORRection:OFFSet?
Instruction	Sets TG level offsets. Gets TG level offsets.
Parameter Type	Float, unit: dBm
Parameter Range	200 dBm ~ -200 dBm
Return	Float
Default	0 dBm
Menu	TG > LeI OffSets
Example	:SOURce:CORRection:OFFSet 1

### 3.9.4 TG Normalize on-off (:CALCulate:NTData[:STATe])

Command Format	:CALCulate:NTData[:STATe] OFF ON 0 1 :CALCulate:NTData[:STATe]?
Instruction	Sets TG normalize on-off. Gets TG normalize state.
Parameter Type	Boolean
Parameter Range	OFF ON 0 1
Return	0 1
Default	0
Menu	TG > Normalize > Normalize
Example	:CALCulate:NTData ON

### 3.9.5 TG Normalize Reference Level (:DISPlay:WINDow:TRACe:Y[:SCALe]:NRLevel)

Command Format	:DISPlay:WINDow:TRACe:Y[:SCALe]:NRLevel <value> :DISPlay:WINDow:TRACe:Y[:SCALe]:NRLevel?
Instruction	Sets TG normalize reference level. Gets TG normalize reference level.
Parameter Type	Float, unit: dB
Parameter Range	-200 dB ~ 200 dB
Return	Float, unit: dB
Default	0 dB
Menu	TG > Normalize > Ref Lvl
Example	:DISPlay:WINDow:TRACe:Y:NRLevel 10

### 3.9.6 TG Normalize Reference Position (:DISPlay:WINDow:TRACe:Y[:SCALe]:NRPosition)

Command	:DISPlay:WINDow:TRACe:Y[:SCALe]:NRPosition <integer>
---------	--

## SIGLENT

Format	:DISPlay:WINDow:TRACe:Y[:SCALe]:NRPosition?
Instruction	Sets TG normalize reference position. Gets TG normalize reference position.
Parameter Type	Integer
Parameter Range	0 ~ 100%
Return	Float
Default	100%
Menu	TG > Normalize > Position
Example	:DISPlay:WINDow:TRACe:Y:NRPosition 10

### 3.9.7 TG Normalize Reference Trace on-off (:DISPlay:WINDow:NTTRace[:STATe])

Command Format	:DISPlay:WINDow:NTTRace[:STATe] OFF ON 0 1 :DISPlay:WINDow:NTTRace[:STATe]?
Instruction	Sets TG normalize reference trace on-off.
Parameter Type	Boolean
Parameter Range	OFF ON 0 1
Return	0 1
Default	0
Menu	TG > Normalize > Ref Trace
Example	:DISPlay:WINDow:NTTRace ON

## 3.10 Demod Subsystem

### 3.10.1 Demod Mode ([:SENSe]:DEMod)

Command Format	[:SENSe]:DEMod AM FM OFF [:SENSe]:DEMod?
Instruction	Sets demod mode. Gets demod mode.
Parameter Type	Enumeration
Parameter Range	AM FM OFF
Return	Enumeration
Default	OFF
Menu	Demod
Example	:DEMod AM

### 3.10.2 Demod Time ([:SENSe]:DEMod:TIME)

Command Format	[:SENSe]:DEMod:TIME <time> [:SENSe]:DEMod:TIME?
Instruction	Sets demod time. Gets demod time.
Parameter Type	Float, unit: ms, us, s

Parameter Range	5 ms ~1000 s
Return	Float, unit: s
Default	5 ms
Menu	Demod
Example	DEMod:TIME 5 ms

### 3.10.3 Earphone ([:SENSe]:DEMod:EPHONE)

Command Format	[:SENSe]:DEMod:EPHONE OFF ON 0 1 [:SENSe]:DEMod:EPHONE?
Instruction	Sets earphone on-off. Gets earphone on-off.
Parameter Type	Boolean
Parameter Range	OFF ON 0 1
Return	0 1
Default	OFF
Menu	Demod > Earphone
Example	:DEMod:EPHONE ON

### 3.10.4 Volume ([:SENSe]:DEMod:VOLUME)

Command Format	[:SENSe]:DEMod:VOLUME <value> [:SENSe]:DEMod:VOLUME?
Instruction	Sets volume value. Gets volume value.
Parameter Type	Integer
Parameter Range	0 ~ 10
Return	Integer
Default	6
Menu	Demod > Volume
Example	:DEMod:EPHONE ON

## 3.11 Calibration Subsystem

### 3.11.1 Calibration on-off ([:SENSe]:CALibration:STATE)

Command Format	[:SENSe]:CALibration:STATE OFF ON 0 1 [:SENSe]:CALibration:STATE?
Instruction	Sets calibration on-off. Gets calibration on-off.
Parameter Type	Boolean
Parameter Range	OFF ON 0 1
Return	0 1
Default	OFF

---

Menu	Syetem > Calibration > Auto Cal
Example	:CALibration:STATe ON

## 3.12 Memory Subsystem

### 3.12.1 Store File (:MMEMory:STORe)

Command Format	:MMEMory:STORe STA TRC COR CSV LIM JPG BMP PNG,<file>
Instruction	Store file
Parameter Type	String
Parameter Range	None
Return	None
Default	None
Menu	File > Save
Example	:MMEMory:STORe STA,ABC.sta

### 3.12.2 Load File (:MMEMory:LOAD)

Command Format	:MMEMory:LOAD STA TRC COR LIM,<file>
Instruction	Load file
Parameter Type	String
Parameter Range	None
Return	None
Default	None
Menu	File > Open/Load
Example	:MMEMory:LOAD STA,ABC.sta

### 3.12.3 Delete File (:MMEMory:DELeTe)

Command Format	:MMEMory:DELeTe <file>
Instruction	Delete file or folder
Parameter Type	String
Parameter Range	None
Return	None
Default	None
Menu	File > Operate > Delete
Example	:MMEMory:DELeTe ABC.sta



# 4. Programming Examples

This chapter gives some examples for the programmer. In these examples you can see how to use the VISA or sockets, in combination with the commands have been described above to control the spectrum analyzer. By following these examples, you can develop many more applications.

## 4.1 Examples of Using VISA

### 4.1.1 Example of VC++

**Environment:** Win7 32bit system, Visual Studio

**The functions of this example:** use the NI-VISA, to control the device with USBTMC or TCP/IP access to do a write and read.

Follow the steps to finish the example:

- 1、 Open Visual Studio, create a new VC++ win32 console project.
- 2、 Set the project environment to use the NI-VISA lib, there are two ways to use NI-VISA, static or automatic:
  - (1) Static: find files: visa.h, visatype.h, visa32.lib in NI-VISA install path. Copy them to your project, and add them into project. In the projectname.cpp file, add the follow two lines:

```
#include "visa.h"
```

```
#pragma comment(lib,"visa32.lib")
```

- (2) Automatic:

Set the .h file include directory, the NI-VISA install path, in our computer we set the path is: C:\Program Files\IVI Foundation\VISAWinNT\include. Set this path to project---properties---c/c+---General---Additional Include Directories: See the picture.

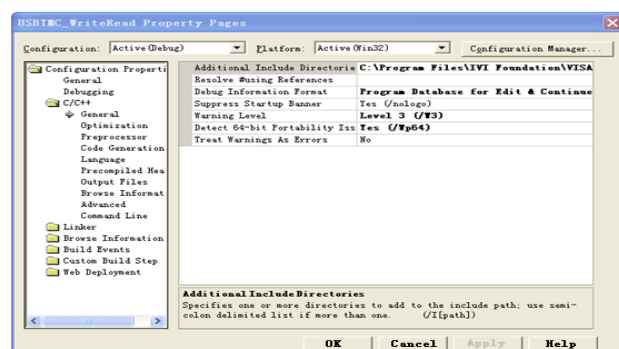

Set lib path set lib file:

Set lib path: the NI-VISA install path, in our computer we set the path is: C:\Program Files\IVI Foundation\VISAWinNT

lib\msc. Set this path to project---properties---Linker---General---Additional Library Directories: as seen in the pictures below.

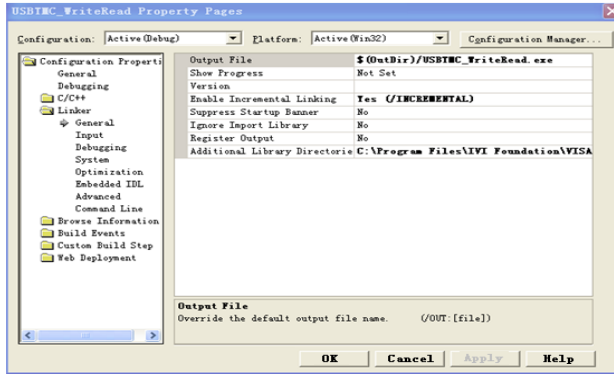

Set lib file:project---properties---Linker---Command Line---Additional Options: visa32.lib

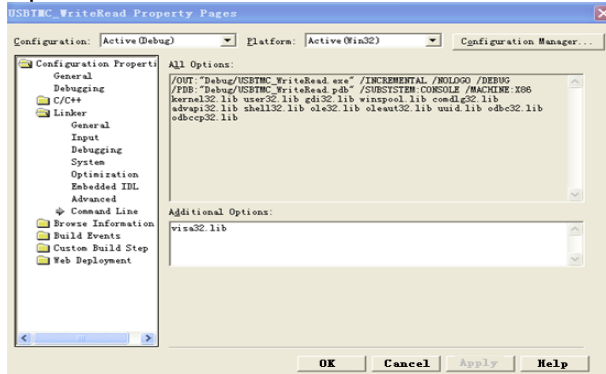

Include visa.h file: In the projectname.cpp file:

```
#include <visa.h>
```

3、 Add codes:

(1)USBTMC access code.

Write a function Usbtmc\_test:

```
int Usbtmc_test()
{
    /* This code demonstrates sending synchronous read & write commands */
    /* to an USB Test & Measurement Class (USBTMC) instrument using */
    /* NI-VISA */
    /* The example writes the "*IDN?\n" string to all the USBTMC */
    /* devices connected to the system and attempts to read back */
    /* results using the write and read functions. */
    /* The general flow of the code is */
    /* Open Resource Manager */
    /* Open VISA Session to an Instrument */
    /* Write the Identification Query Using viPrintf */
    /* Try to Read a Response With viScanf */
    /* Close the VISA Session */
    /*******/
    ViSessiondefaultRM;
    ViSessioninstr;
    ViUInt32numInstrs;
    ViFindListfindList;
    ViStatus status;
    char instrResourceString[VI_FIND_BUFLLEN];
    unsignedchar buffer[100];
    inti;
    /** First we must call viOpenDefaultRM to get the manager
    * handle. We will store this handle in defaultRM.*/
    status=viOpenDefaultRM (&defaultRM);
    if (status<VI_SUCCESS)
    {
        printf ("Could not open a session to the VISA Resource Manager!\n");
        returnstatus;
    }
}
```

```

/* Find all the USB TMC VISA resources in our system and store the number of resources in the system in
numInstrs.*/
status = viFindRsrc (defaultRM, "USB?*INSTR", &findList, &numInstrs, instrResourceString);
if (status<VI_SUCCESS)
{
printf ("An error occurred while finding resources.\nPress 'Enter' to continue.");
fflush(stdin);
getchar();
viClose (defaultRM);
returnstatus;
}
/** Now we will open VISA sessions to all USB TMC instruments.
* We must use the handle from viOpenDefaultRM and we must
* also use a string that indicates which instrument to open. This
* is called the instrument descriptor. The format for this string
* can be found in the function panel by right clicking on the
* descriptor parameter. After opening a session to the
* device, we will get a handle to the instrument which we
* will use in later VISA functions. The AccessMode and Timeout
* parameters in this function are reserved for future
* functionality. These two parameters are given the value VI_NULL.*/
for (i=0; i<int(numInstrs); i++)
{
if (i> 0)
{ viFindNext (findList, instrResourceString);
}status = viOpen (defaultRM, instrResourceString, VI_NULL, VI_NULL, &instr);
if (status<VI_SUCCESS)
{
printf ("Cannot open a session to the device %d.\n", i+1);
continue;
}
/* * At this point we now have a session open to the USB TMC instrument.
* We will now use the viPrintf function to send the device the string "**IDN?\n",
* asking for the device's identification. */
char * cmmand ="**IDN?\n";
status = viPrintf (instr, cmmand);
if (status<VI_SUCCESS)
{
printf ("Error writing to the device %d.\n", i+1);
status = viClose (instr);
continue;
}
/** Now we will attempt to read back a response from the device to
* the identification query that was sent. We will use the viScanf
* function to acquire the data.
* After the data has been read the response is displayed.*/
status = viScanf(instr, "%t", buffer);
if (status<VI_SUCCESS)
{ printf ("Error reading a response from the device %d.\n", i+1);
} else
{ printf ("\nDevice %d: %s\n", i+1, buffer);
}status = viClose (instr);
}
/** Now we will close the session to the instrument using
* viClose. This operation frees all system resources. */
status = viClose (defaultRM);
printf("Press 'Enter' to exit.");
fflush(stdin);
getchar();return 0;
}

int _tmain(int argc, _TCHAR* argv[])
{
Usbtmc_test();
return 0;
}

```

**Run result.**

```
C:\Documents and Settings\Peter.Chen\My Documents\Visual Studio Proje...
Device 1: Siglent Technologies,SDG6032X,SDG6X03173458F,2.01.01.27R7
Press 'Enter' to exit.
```

(2)TCP/IP access code.

Write a function TCP\_IP\_Test:

```
int TCP_IP_Test(char *pIP)
{
    char outputBuffer[VI_FIND_BUFLLEN];
    ViSessiondefaultRM, instr;
    ViStatusstatus;

    /* First we will need to open the default resource manager. */
    status = viOpenDefaultRM (&defaultRM);
    if (status<VI_SUCCESS)
    {
        printf("Could not open a session to the VISA Resource Manager!\n");
    }
    /* Now we will open a session via TCP/IP device */
    char head[256] ="TCPIP0::";
    char tail[] ="::INSTR";

    strcat(head,pIP);
    strcat(head,tail);
    status = viOpen (defaultRM, head, VI_LOAD_CONFIG, VI_NULL, &instr);
    if (status<VI_SUCCESS)
    {
        printf ("An error occurred opening the session\n");
        viClose(defaultRM);
    }
    status = viPrintf(instr, "%dn?\n");
    status = viScanf(instr, "%t", outputBuffer);
    if (status<VI_SUCCESS)
    {
        printf("viRead failed with error code: %x \n",status);
        viClose(defaultRM);
    }else
    {printf ("\nMesseage read from device: %*s\n", 0,outputBuffer);
    } status = viClose (instr);
    status = viClose (defaultRM);
    printf("Press 'Enter' to exit.");
    fflush(stdin);
    getchar();return 0;
}

int _tmain(int argc, _TCHAR* argv[])
{
    printf("Please input IP address:");
    char ip[256];
    fflush(stdin);
    gets(ip);
    TCP_IP_Test(ip);
    return 0;
}
```

**Run result.**

```

C:\Documents and Settings\Peter.Chen\My Documents\Visual Studio Proje... - [ ] X
Please input IP address:10.11.13.238

Message read from device: Siglent Technologies,SDG6032X,SDG6X03173458F,2.01.01.
27R7

Press 'Enter' to exit.

```

## 4.1.2 Example of VB

**Environment:** Win7 32bit system, Microsoft Visual Basic 6.0

**The function of this example:** Use the NI-VISA, to control the device with USBTMC and TCP/IP access to do a write and read.

Follow the steps to complete the example:

- 1、 Open Visual Basic, build a standard application program project (Standard EXE)
- 2、 Set the project environment to use the NI-VISA lib, Click the Existing tab of Project>>Add Existing Item. Search for the visa32.bas file in the include folder under the NI-VISA installation path and add the file.

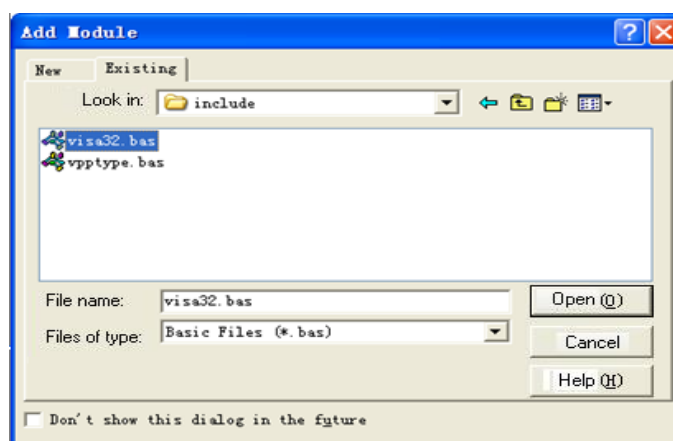

This allows the VISA functions and VISA data types to be used in a program.

- 3、 Add codes:

(1)USBTMC access code.

Write a function Usbtmc\_test:

```
Private Function Usbtmc_test() As Long
```

```

' This code demonstrates sending synchronous read & write commands
' to an USB Test & Measurement Class (USBTMC) instrument using
' NI-VISA
' The example writes the "*IDN?\n" string to all the USBTMC
' devices connected to the system and attempts to read back
' results using the write and read functions.
' The general flow of the code is
' Open Resource Manager
' Open VISA Session to an Instrument
' Write the Identification Query Using viWrite
' Try to Read a Response With viRead
' Close the VISA Session

```

```
Const MAX_CNT = 200

Dim defaultRM As Long
Dim instrsesn As Long
Dim numInstrs As Long
Dim findList As Long
Dim retCount As Long

Dim status As Long
Dim instrResourceString As String * VI_FIND_BUFLen
Dim Buffer As String * MAX_CNT
Dim i As Integer

' First we must call viOpenDefaultRM to get the manager
' handle. We will store this handle in defaultRM.

status = viOpenDefaultRM(defaultRM)
If (status < VI_SUCCESS) Then
    resultTxt.Text = "Could not open a session to the VISA Resource Manager!"
    Usbtmc_test = status
    Exit Function
End If

' Find all the USB TMC VISA resources in our system and store the
' number of resources in the system in numInstrs.

status = viFindRsrc(defaultRM, "USB?*INSTR", findList, numInstrs, instrResourceString)
If (status < VI_SUCCESS) Then
    resultTxt.Text = "An error occurred while finding resources."
    viClose (defaultRM)
    Usbtmc_test = status
    Exit Function
End If

' Now we will open VISA sessions to all USB TMC instruments.
' We must use the handle from viOpenDefaultRM and we must
' also use a string that indicates which instrument to open. This
' is called the instrument descriptor. The format for this string
' can be found in the function panel by right clicking on the
' descriptor parameter. After opening a session to the
' device, we will get a handle to the instrument which we
' will use in later VISA functions. The AccessMode and Timeout
' parameters in this function are reserved for future
' functionality. These two parameters are given the value VI_NULL.

For i = 0 To numInstrs
    If (i > 0) Then
        status = viFindNext(findList, instrResourceString)
    End If
    status = viOpen(defaultRM, instrResourceString, VI_NULL, VI_NULL, instrsesn)
    If (status < VI_SUCCESS) Then
        resultTxt.Text = "Cannot open a session to the device " + CStr(i + 1)
        GoTo NextFind
    End If

    ' At this point we now have a session open to the USB TMC instrument.
    ' We will now use the viWrite function to send the device the string "*IDN?",
    ' asking for the device's identification.

    status = viWrite(instrsesn, "*IDN?", 5, retCount)
    If (status < VI_SUCCESS) Then
        resultTxt.Text = "Error writing to the device."
        status = viClose(instrsesn)
        GoTo NextFind
    End If
End For
```

```

' Now we will attempt to read back a response from the device to
' the identification query that was sent. We will use the viRead
' function to acquire the data.
' After the data has been read the response is displayed.
status = viRead(instrsesn, Buffer, MAX_CNT, retCount)
If (status < VI_SUCCESS) Then
    resultTxt.Text = "Error reading a response from the device." + CStr(i + 1)
Else
    resultTxt.Text = "Read from device: " + CStr(i + 1) + " " + Buffer
End If
status = viClose(instrsesn)

Next i

' Now we will close the session to the instrument using
' viClose. This operation frees all system resources.
status = viClose(defaultRM)
Usbtmc_test = 0
End Function

(2)TCP/IP access code.
Write a function TCP_IP_Test:
Private Function TCP_IP_Test(ByVal ip As String) As Long
Dim outputBuffer As String * VI_FIND_BUFLEN
Dim defaultRM As Long
Dim instrsesn As Long
Dim status As Long
Dim count As Long

' First we will need to open the default resource manager.
status = viOpenDefaultRM (defaultRM)
If (status < VI_SUCCESS) Then
    resultTxt.Text = "Could not open a session to the VISA Resource Manager!"
    TCP_IP_Test = status
Exit Function
End If

' Now we will open a session via TCP/IP device
status = viOpen(defaultRM, "TCPIP0::" + ip + "::INSTR", VI_LOAD_CONFIG, VI_NULL, instrsesn)
If (status < VI_SUCCESS) Then
    resultTxt.Text = "An error occurred opening the session"
    viClose (defaultRM)
    TCP_IP_Test = status
Exit Function
End If

status = viWrite(instrsesn, "**IDN?", 5, count)
If (status < VI_SUCCESS) Then
    resultTxt.Text = "Error writing to the device."
End If
status = viRead(instrsesn, outputBuffer, VI_FIND_BUFLEN, count)
If (status < VI_SUCCESS) Then
    resultTxt.Text = "Error reading a response from the device." + CStr(i + 1)
Else
    resultTxt.Text = "read from device:" + outputBuffer
End If
status = viClose(instrsesn)
status = viClose(defaultRM)
TCP_IP_Test = 0
End Function

(3) Button control code:
Private Sub exitBtn_Click()
End
End Sub
Private Sub tcpipBtn_Click()

```

```
Dim stat As Long
stat = TCP_IP_Test(ipTxt.Text)
If (stat < VI_SUCCESS) Then
    resultTxt.Text = Hex(stat)
End If
End Sub
Private Sub usbBtn_Click()
    Dim stat As Long
    stat = Usbtmc_test
    If (stat < VI_SUCCESS) Then
        resultTxt.Text = Hex(stat)
    End If
End Sub
```

### Run result:

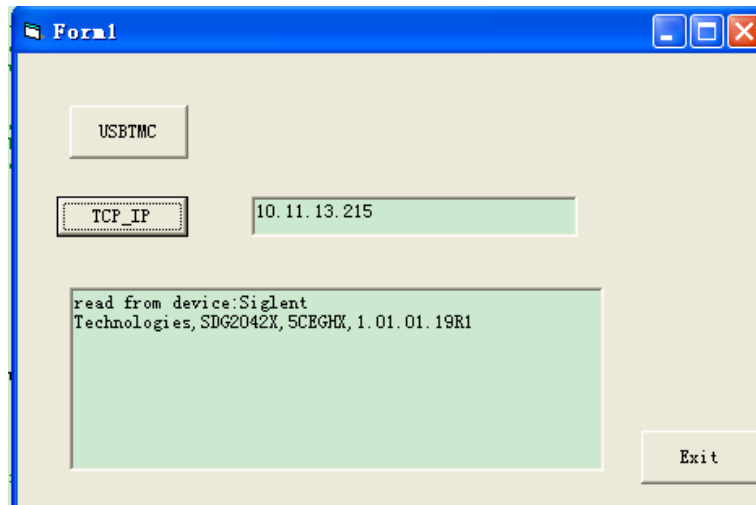

### 4.1.3 Example of MATLAB

**Environment:** Win7 32bit system, MATLAB R2013a

**The function of this example:** Use the NI-VISA, to control the device with USBTMC or TCP/IP access to do a write and read.

Follow the steps to complete the example:

1、 Open MATLAB, modify the **current directory**. In this demo, the current directory is modified to D:\USBTMC\_TCPIP\_Demo.

2、 Click **File>>New>>Script** in the Matlab interface to create an empty M file

3、 Add codes:

(1)USBTMC access code

Write a function Usbtmc\_test.

```
function Usbtmc_test()
```

```
% This code demonstrates sending synchronous read & write commands  
% to an USB Test & Measurement Class (USBTMC) instrument using  
% NI-VISA
```

```
%Create a VISA-USB object connected to a USB instrument
```

```
vu = visa('ni','USB0::0xF4ED::0xEE3A::sdg2000x::INSTR');
```

```
%Open the VISA object created
```

```
fopen(vu);
```

```
%Send the string "**IDN?",asking for the device's identification.
```



```
fprintf(vu, '*IDN?');

%Request the data
outputbuffer = fscanf(vu);
disp(outputbuffer);

%Close the VISA object
fclose(vu);
delete(vu);
clear vu;

end
```

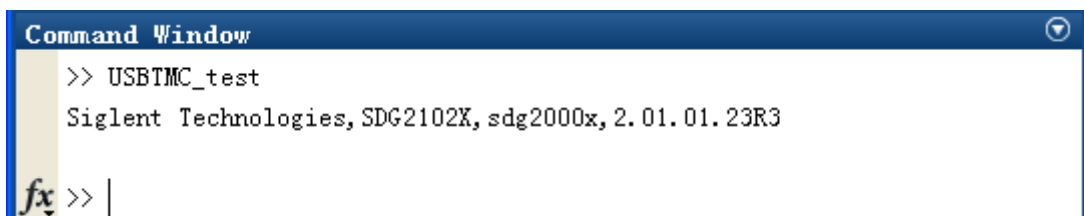
**Run result:**

```
Command Window
>> USBTMC_test
Siglent Technologies, SDG2102X, sdg2000x, 2.01.01.23R3
fx >> |
```

## 2) TCP/IP access code.

Write a function TCP\_IP\_Test:

```
function TCP_IP_test()
% This code demonstrates sending synchronous read & write commands
% to an TCP/IP instrument using NI-VISA

%Create a VISA-TCPIP object connected to an instrument
%configured with IP address.
vt = visa('ni', ['TCPIP0:', '10.11.13.32', '::INSTR']);

%Open the VISA object created
fopen(vt);

%Send the string "*IDN?", asking for the device's identification.
fprintf(vt, '*IDN?');

%Request the data
outputbuffer = fscanf(vt);
disp(outputbuffer);

%Close the VISA object
fclose(vt);
delete(vt);
clear vt;

end
```

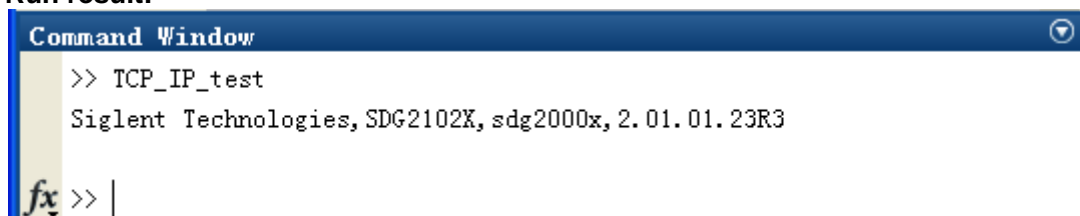
**Run result:**

```
Command Window
>> TCP_IP_test
Siglent Technologies, SDG2102X, sdg2000x, 2.01.01.23R3
fx >> |
```

## 4.1.4 Example of LabVIEW

**Environment:** Win7 32bit system, LabVIEW 2011

**The functions of this example:** use the NI-VISA, to control the device with USBTMC and TCP/IP access to do a write and read.

## SIGLENT

Follow the steps to complete the example:

- 1、 Open LabVIEW, create a VI file.
- 2、 Add controls. Right-click in the **Front Panel** interface, select and add **VISA resource name**, error in, error out and some indicators from the Controls column.
- 3、 Open the **Block Diagram** interface. Right-click on the **VISA resource name** and you can select and add the following functions from VISA Palette from the pop-up menu: **VISA Write**, **VISA Read**, **VISA Open** and **VISA Close**.
- 4、 Connect them as shown in the figure below

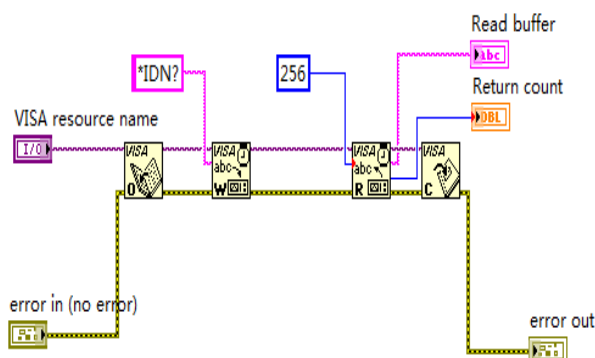

- 5、 Select the device resource from the VISA Resource Name list box and run the program.

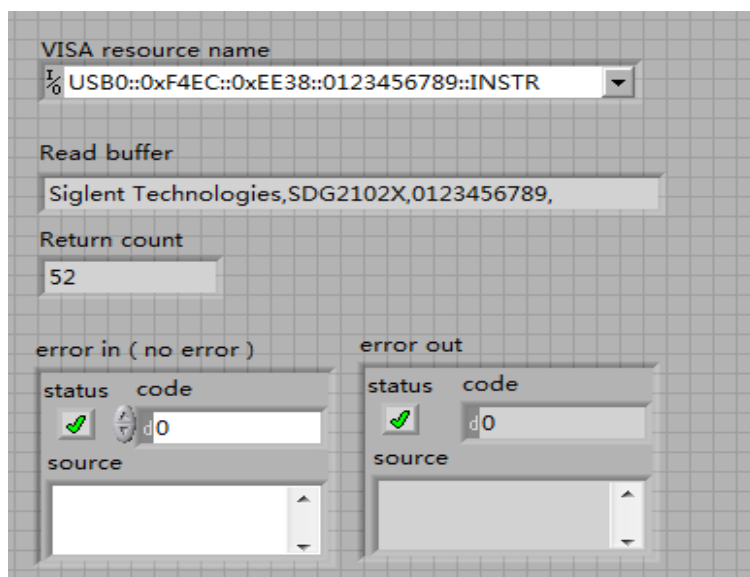

In this example, the VI opens a VISA session to a USBTMC device, writes a command to the device, and reads back the response. In this example, the specific command being sent is the device ID query. Check with your device manufacturer for the device command set. After all communication is complete, the VI closes the VISA session.

- 6、 Communicating with the device via TCP/IP is similar to USBTMC. But you need to change VISA Write and VISA Read Function to Synchronous I/O. The LabVIEW default is asynchronous I/O. Right-click the node and select Synchronous I/O Mod>>Synchronous from the shortcut menu to write or read data synchronously.
- 7、 Connect them as shown in the figure below

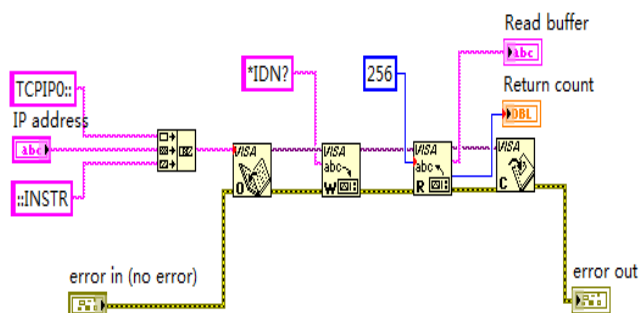

8、 Input the IP address and run the program.

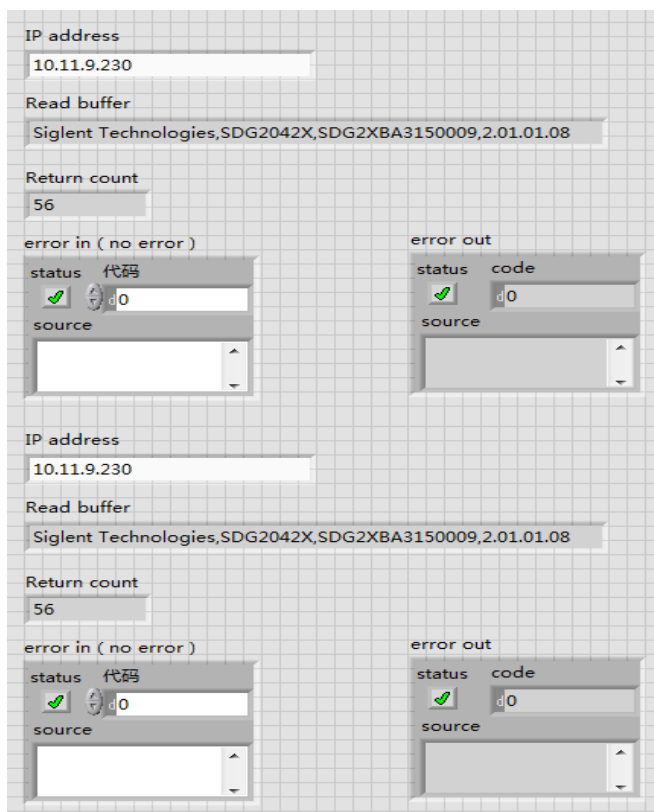

## 4.2 Examples of Using Sockets/Telnet

### 4.2.1 Example of Python

Python is an interpreted programming language that lets you work quickly and is very portable. Python has a low-level networking module that provides access to the socket interface. Python scripts can be written for sockets to do a variety of test and measurements tasks.

**Environment:** Win7 32bit system, Python v2.7.5

**The functions of this example:** Open a socket, sends a query, and closes the socket. It does this loop 10 times.

Below is the code of the script:

```
#!/usr/bin/env python
#-*- coding:utf-8 -*-
#-----
# The short script is a example that open a socket, sends a query,
# print the return message and closes the socket.
#-----
import socket # for sockets
import sys # for exit
import time # for sleep
#-----
remote_ip = "10.11.13.32" # should match the instrument's IP address
port = 5024 # the port number of the instrument service
count = 0

def SocketConnect():
    try:
        #create an AF_INET, STREAM socket (TCP)
        s = socket.socket(socket.AF_INET, socket.SOCK_STREAM)
    except socket.error:
        print ('Failed to create socket.')
        sys.exit();
    try:
        #Connect to remote server
        s.connect((remote_ip , port))
        info = s.recv(4096)
        print (info)
    except socket.error:
        print ('failed to connect to ip ' + remote_ip)
    return s

def SocketQuery(Sock, cmd):
    try :
        #Send cmd string
        Sock.sendall(cmd)
        time.sleep(1)
    except socket.error:
        #Send failed
        print ('Send failed')
        sys.exit()
    reply = Sock.recv(4096)
    return reply

def SocketClose(Sock):
    #close the socket
```

```

Sock.close()
time.sleep(.300)

def main():
    global remote_ip
    global port
    global count

    # Body: send the SCPI commands *IDN? 10 times and print the return message
    s = SocketConnect()
    for i in range(10):
        qStr = SocketQuery(s, b'*IDN?')
        print (str(count) + ":: " + str(qStr))
        count = count + 1    SocketClose(s)
    input('Press "Enter" to exit')

if __name__ == '__main__':
    proc = main()

```

#### Run result:

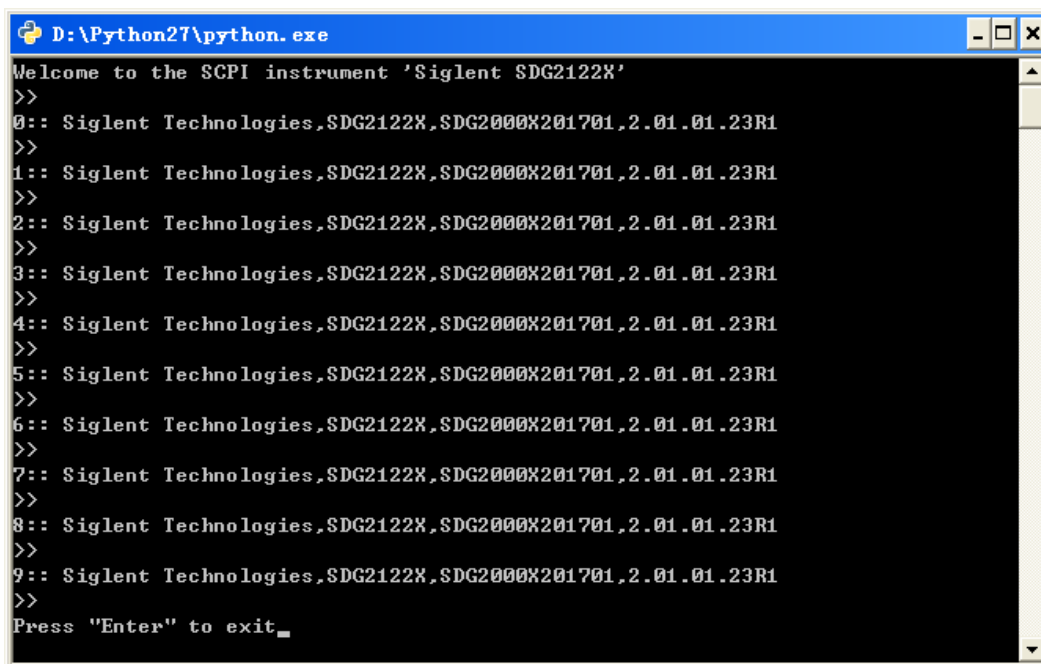

```

D:\Python27\python.exe
Welcome to the SCPI instrument 'Siglent SDG2122X'
>>
0:: Siglent Technologies,SDG2122X,SDG2000X201701,2.01.01.23R1
>>
1:: Siglent Technologies,SDG2122X,SDG2000X201701,2.01.01.23R1
>>
2:: Siglent Technologies,SDG2122X,SDG2000X201701,2.01.01.23R1
>>
3:: Siglent Technologies,SDG2122X,SDG2000X201701,2.01.01.23R1
>>
4:: Siglent Technologies,SDG2122X,SDG2000X201701,2.01.01.23R1
>>
5:: Siglent Technologies,SDG2122X,SDG2000X201701,2.01.01.23R1
>>
6:: Siglent Technologies,SDG2122X,SDG2000X201701,2.01.01.23R1
>>
7:: Siglent Technologies,SDG2122X,SDG2000X201701,2.01.01.23R1
>>
8:: Siglent Technologies,SDG2122X,SDG2000X201701,2.01.01.23R1
>>
9:: Siglent Technologies,SDG2122X,SDG2000X201701,2.01.01.23R1
>>
Press "Enter" to exit_

```

## 4.2.2 Example of Telnet

**Telnet SCPI:** Provides the ability to send single SCPI commands from a remote PC to the analyzer using LAN port number 5024.

How to send single SCPI commands using Telnet:

1. On the remote PC, click **Start**, then **Run**
2. Type: **telnet <ip address> 5024**
3. A Telnet window with a >> prompt should appear on the remote PC screen.
4. From the SCPI prompt:
  - Type single SCPI commands. Press **Enter** to send the command.

## SIGLENT

---

- To exit the telnet window click **X** in the upper-right corner.
- To get a normal telnet prompt, press **Ctrl ]** (closing bracket).
- To get SCPI prompt again, type **open** <ip Address> **5024**.
- To close the normal telnet window, type **Quit** and press **Enter**.